

# GLOBO

LIGHTING  
www.globo-lighting.com

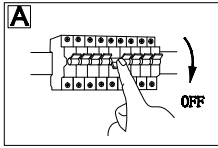

**B**

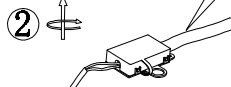
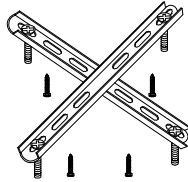

15548-6D

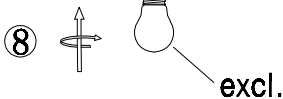
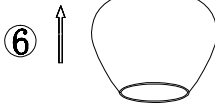
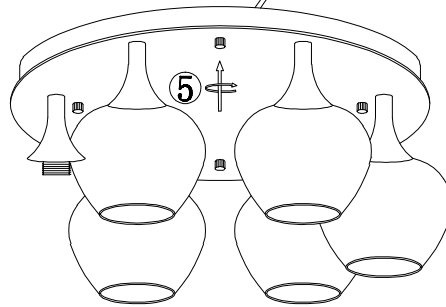
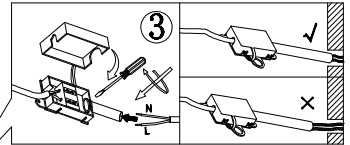

6x MAX 40W E27  
230V~ 50Hz

GLOBO Handels GmbH  
Gewerbestr. 3  
A-9184 Sankt Peter  
Austria

