

GLOBO

LIGHTING

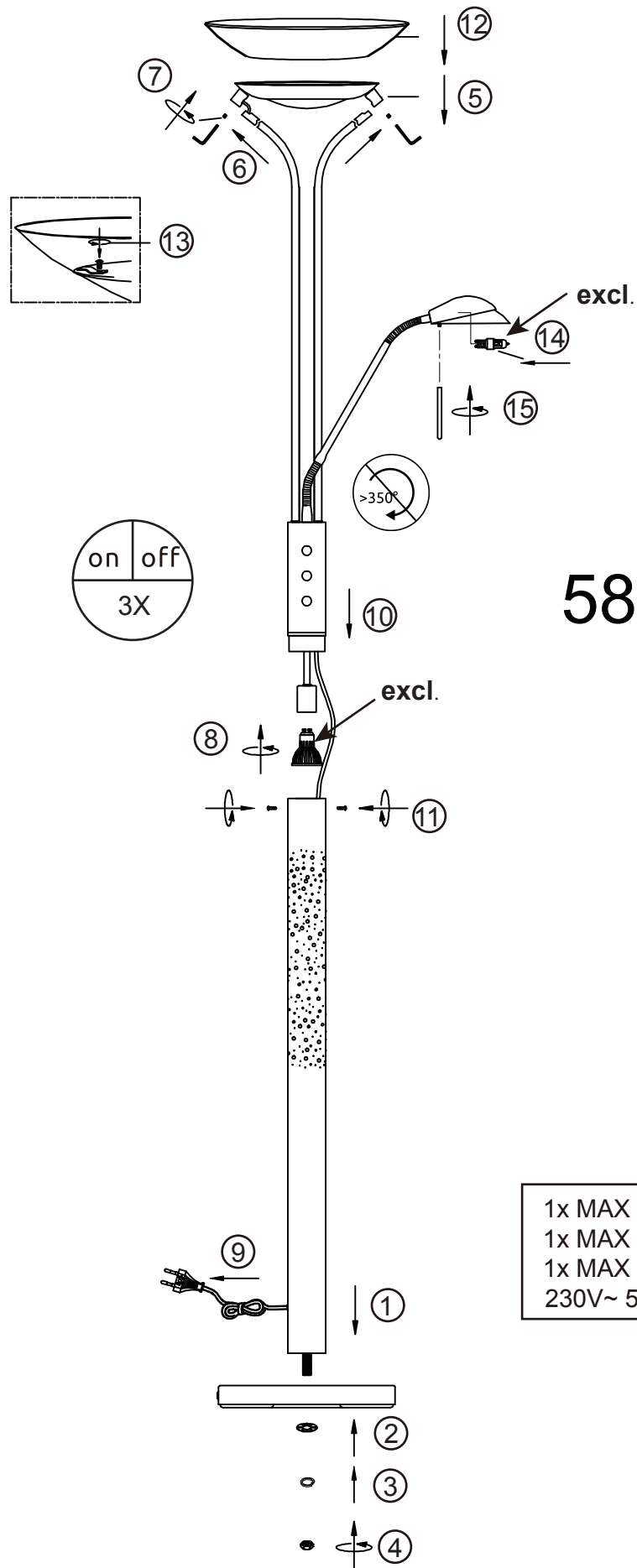

58908

- | |
|---------------------------|
| 1x MAX 40W LED 240-300V |
| 1x MAX 11W LED G9 excl. |
| 1x MAX 10W LED GU10 excl. |
| 230V~ 50/60Hz |

GLOBO Handels GmbH
 Gewerbestrasse 3
 A-9184 Sankt Peter Austria
 www.globo-lighting.com
 office@globo-lighting.com

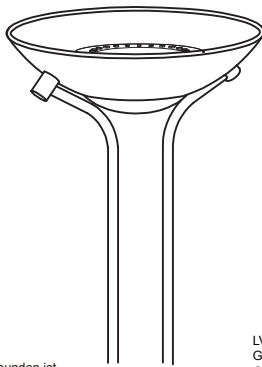



DEU:

Lichtquelle:

Die Lichtquelle ist nicht tauschbar, weil sie konstruktionsbedingt fest mit dem umgebenden Produkt verbunden ist. Dieses Produkt enthält eine Lichtquelle der Energieeffizienzklasse <E>.



   Die LED - Lichtquelle ist nicht austauschbar.



  Das Betriebsgerät ist nicht austauschbar.

GBR:

Light source:

The light source is not interchangeable because it is determined by the surrounding product design. This product contains a light source of energy efficiency class <E>.

   The LED - light source cannot be replaced.

  The control gear cannot be replaced.

BG:

Източник на светлина:

Източникът на светлина не може да се подменя, тъй като поради конструкцията си е трайно фиксиран към заобикалящия го продукт. Този продукт включва светлинен източник с клас на енергийна ефективност <E>



   LED източникът на светлина не може да се подменя.



  Устройството за управление не може да се подменя.

CZ:

Zdroj světla:

Světelný zdroj není možné vyměnit, protože je díky své konstrukci pevně spojený s produktem. Tento výrobek obsahuje světelný zdroj s třídou energetické účinnosti <E>.

   Světelný zdroj není vyměnitelný.

  Předřadník není vyměnitelný.

DK:

Lyskilde:

Lyskilden kan ikke udskiftes, fordi den er fast forbundet med det omgivende produkt. Dette produkt indeholder en lyskilde i energieffektivitetsklasse <E>.

   LED - lyskilden kan ikke udskiftes.



  Driftsenheden kan ikke udskiftes.

ES:

Fuente de luz:

La fuente de luz no es sustituible porque está fija en el producto desde la construcción. Este producto contiene una fuente luminosa de la clase de eficiencia energética <E>.



   Bombilla no reemplazable.



  Dispositivo de control no reemplazable.

ET:

Valgusallikas:

Valgusallikas ei ole välja vahetatav, sest ta on tootega ehituslikult kindlalt seotud. Toode sisaldab energiatõhususe klassi <E> valgusallikat.

   LED - valgusallikat ei saa asendada.

  Juhtseadet ei saa asendada.

FI:

Valonlähde:

Valonlähdeä ei voi vaihtaa uuteen, sillä se on rakenteellisesti yhdistetty ympäröivään tuoteeseen. Tämä tuote sisältää valonlähteen, jonka energiatehokkuusluokka on <E>.

   LED-valonlähdeä ei voi vaihtaa uuteen.

  Liitäntälaitetta ei voi vaihtaa uuteen.

FR:

Source lumineuse:

La source lumineuse n'est pas remplaçable car elle est, de par la construction du produit, liée de façon permanente à celui-ci. Ce produit contient une source lumineuse de classe d'efficacité énergétique <E>.

   La source lumineuse LED n'est pas remplaçable.



  L'unité de contrôle n'est pas remplaçable.

GR:

Φωτεινή πηγή:

Η φωτεινή πηγή δεν μπορεί να αντικατασταθεί, επειδή είναι για κατασκευαστικούς λόγους σταθερά συνδεδεμένη με το προϊόν που την περιβάλλει. Το προϊόν αυτό περιέχει φωτεινή πηγή της τρίτης ενεργειακής απόδοσης <E>.



   Η φωτεινή πηγή LED δεν αντικαθίσταται.



  Η λειτουργική συσκευή δεν αντικαθίσταται.

HR:

Izvor svjetla:

Izvor svjetla nije zamjenjiv, jer je konstrukcijski pričvršćen na proizvod. Ovaj proizvod sadržava izvor svjetlosti klase energetske učinkovitosti <E>.

   LED – izvor svjetla nije moguće zamjeniti

  Pogonski uređaj se ne može zamjeniti.

HU:

Fényforrás:

A fényforrás nem cserélhető, mert felépítése miatt szilárdan csatlakozik a termékhez. Ez a termék egy <E> energiatételezésű osztályú fényforrást tartalmaz.



   A fényforrás nem cserélhető



  Az előlét nem cserélhető.

Isländisch/IS:

Ljósgrafi:

Ljósgraffinn er ekki útskiptanlegur vegna þess að hann er háður umliggjandi hönnun vörunnar. Varan inniheldur ljósgrafa í orkuflökki <E>.



   Ekki er hægt að skipta um LED-ljósgraffann.



  Ekki er hægt að skipta um stjórmbúnaðinn.

IT:

Avviso per la sorveglianza del mercato:

Per poter accedere alla sorgente luminosa occorre rimuovere gli elementi decorativi; ciò potrebbe comportare la necessità di operare una distruzione meccanica. Questo prodotto contiene una sorgente luminosa di classe di efficienza energetica <E>.





   La sorgente luminosa a LED non può essere sostituita.

  La centralina non può essere sostituita

LV:

Gaismas avots:





Gaismas avotu nevar nomainīt, jo tas konstrukcijā ir cieši savienots ar izstrādājuma apkārtējo daļu. Šis ražojums satur gaismas avotu, kura energoefektivitātes klase ir <E>.

   LED apgaismes līdzekļi nevar nomainīt.   Vadības ierīci nevar nomainīt.

LT:

Šviesos šaltinis:

Šis šviesos šaltinis yra nekeičiamas, nes jis prijungtas prie gaminio pagal jo konstrukciją. Šiame gaminyje yra šviesos šaltinis, kurio energijos vartojimo efektyvumo klasė <E>.

   LED šviesos šaltinis yra nekeičiamas.   Valdymo įtaisas yra nekeičiamas.

NL:

Lichtbron:

De lichtbron kan niet worden vervangen, omdat deze vanwege de constructie vast met het product eromheen verbonden is. Dit product bevat een lichtbron van energie-efficiëntieklasse <E>.

   De LED-lichtbron kan niet worden vervangen.

  Het apparaat kan niet worden vervangen.

Norwegisch/Norwegian / NO:

Lyskilde:

Lyskilden kan ikke byttes fordi den sitter fast i produktet. Dette produktet inneholder en lyskilde i energiklasse <E>.



   LED-lyspæren kan ikke byttes.



  Drivereheten kan ikke byttes.

PL:

Źródło światła:

Źródła światła nie można wymienić, ponieważ jest zintegrowane z produktem ze względu na swoją konstrukcję. Ten produkt zawiera źródło światła o klasie efektywności energetycznej <E>.



   LED - źródło światła nie może być wymienione.



  Nie można wymienić przekładni sterującej.

PT:

Fonte de Luz:

A fonte de luz não é substituível porque devido às suas características construtivas está fixada de forma permanente ao produto circundante. Este produto contém uma fonte de luz da classe de eficiência energética <E>.



   Lâmpada não substituível.



  Equipamento de controlo não substituível.

RO:

Sursa de lumina:

Sursa de lumina nu este inlocuibilă ea fiind parte constructivă a produsului Acest produs conține o sursă de lumină cu clasă de eficiență energetică <E>.

   Sursa de lumina nu poate fi inlocuită



  Driverul nu poate fi inlocuit

RUS:

Источник света:

Источник света не является взаимозаменяемым, поскольку это определяется конструкцией смежного продукта. Данный продукт содержит источник света класса энергоэффективности <E>.



  Светодиодный источник света не подлежит замене.

  Устройство управления не подлежит замене.

SRB:

Izvor svetlosti:

Izvor svetlosti nije zamenjiv, jer je zbog svog dizajna čvrsto povezan sa proizvodom koji ga okružuje. Ovaj proizvod sadrži izvor svetlosti klase energetske efikasnosti <E>.





   LED izvor svetlosti nije zamenjiv.

  Upravljački uređaj nije zamenjiv.

SK:

Zdroj svetla:





Svetelný zdroj nie je možné vymeniť, pretože je vďaka svojej konštrukcii pevne spojený s produktom. Tento výrobok obsahuje svetelný zdroj triedy energetickej účinnosti <E>.

   Svetelný zdroj nie je vymeniteľný.   Predradník nie je vymeniteľný.

SI:

Izvor svetlobe:

Vir svetlobe ni zamenljiv, ker je določen z zasnovno izdelka v okolici. Ta izdelek vsebuje svetlobni vir razreda enerjske učinkovitosti <E>.

   Svetlobni vir ni mogoče zamenjati.   Krmilnik ni mogoče zamenjati.

SE:

Ljuskälla:

Ljuskällan är inte utbyttbar, eftersom den på grund av konstruktionen är fast integrerad i den omgivande produkten. Denna produkt innehåller en ljuskälla med energieffektivitetsklass <E>.



   LED-ljuskällan kan inte bytas ut.   Driftdonet kan inte bytas ut.

TR:

Işık kaynağı:

Konstrüksiyon gereği çevreleyen ürün ile sabit bir şekilde bağlı olduğu için ışık kaynağı değiştirilemez. Bu ürün, <E> enerji sınıfından bir ışık kaynağına sahiptir.

   LED ışık kaynağı değiştirilemez.

  İşletme cihazı değiştirilemez.

UK:

Джерело світла:

Джерело світла не можна обмінювати, оскільки воно міцно пов'язане з навколишнім виробом завдяки своїй конструкції. Цей виріб містить джерело світла класу енергоефективності <E>.

   – джерело світлодіодного світла не можна замінювати.

  – пристрій керування не можна замінювати.