

GLOBO

LIGHTING

67179S1

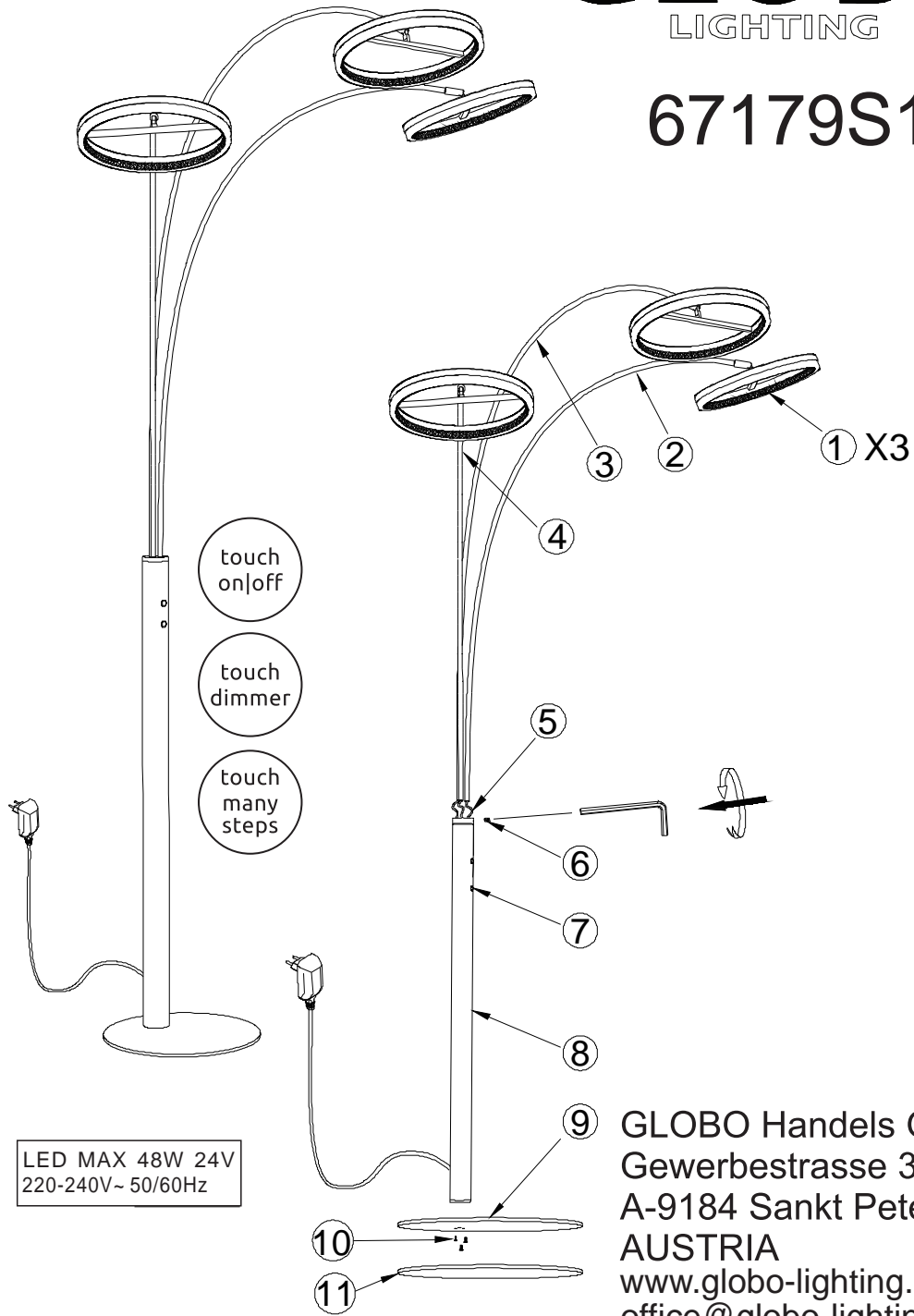

LED MAX 48W 24V
220-240V~ 50/60Hz

GLOBO Handels GmbH
Gwerbestrasse 3
A-9184 Sankt Peter
AUSTRIA
www.globo-lighting.com
office@globo-lighting.com

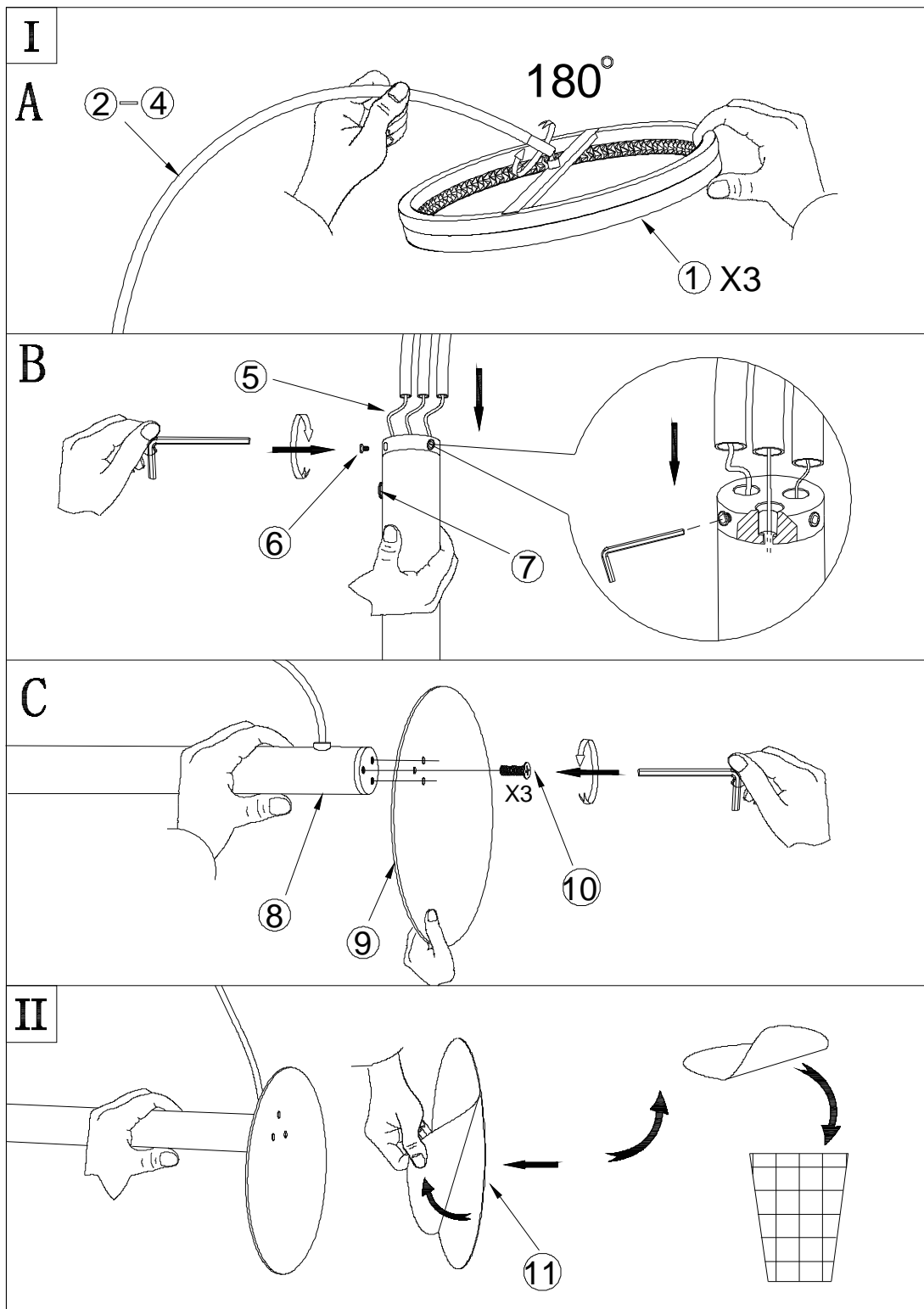

Touch switches

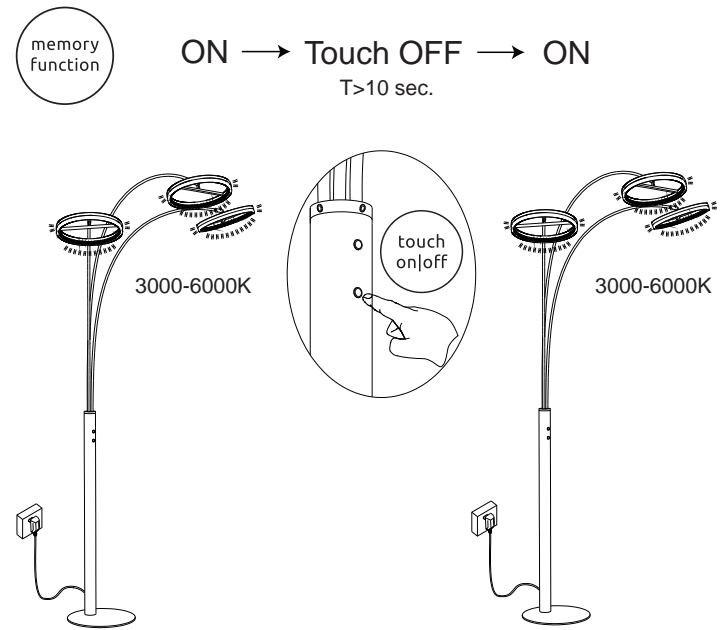
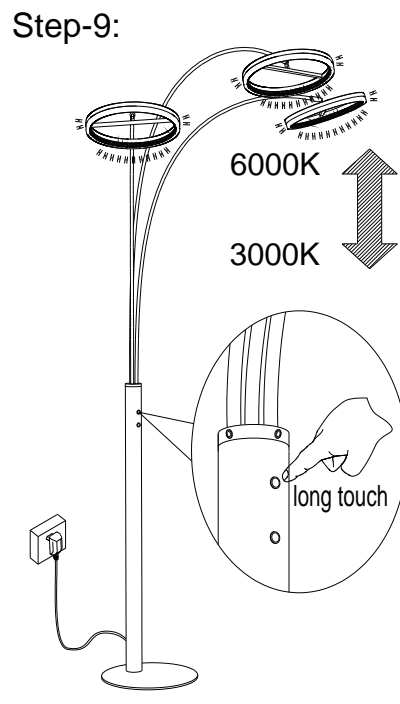
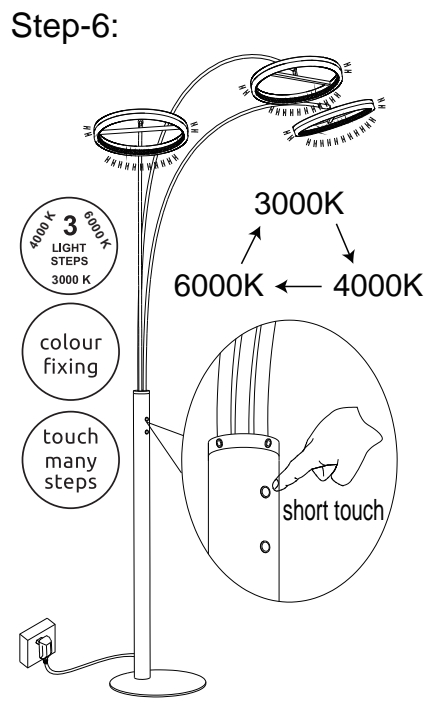
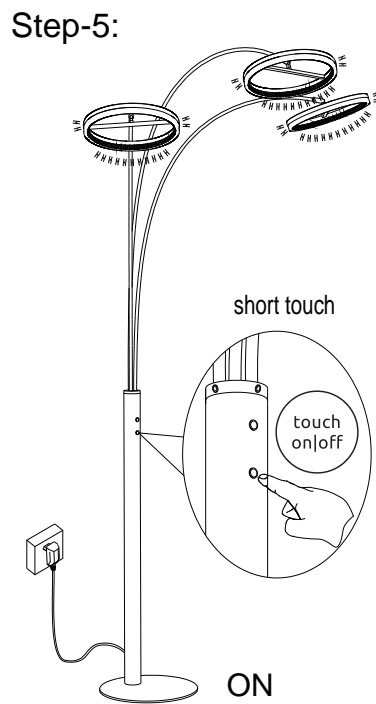
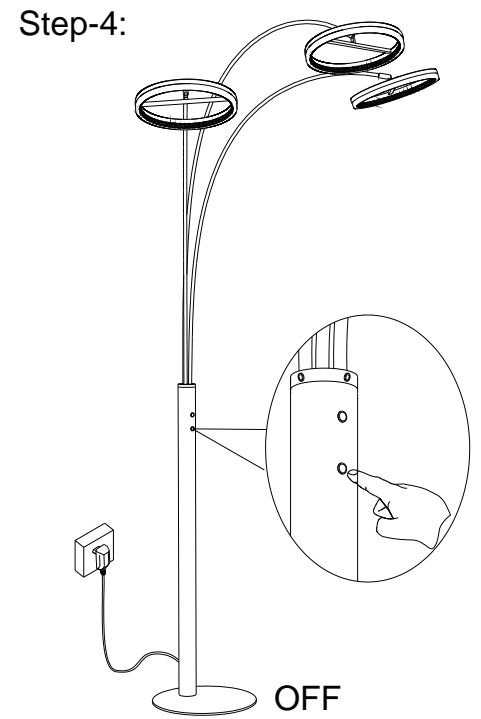
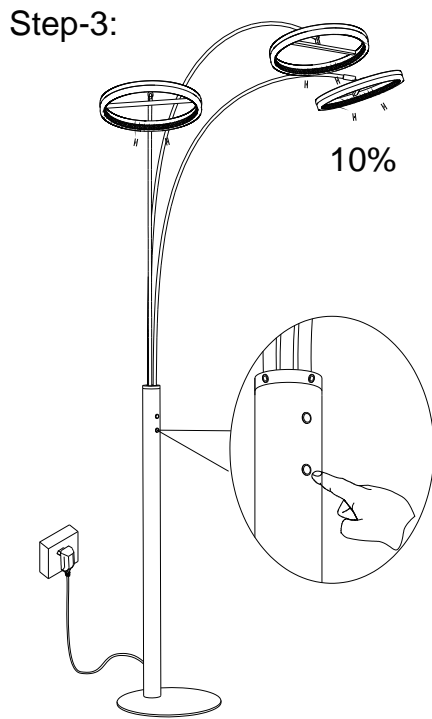
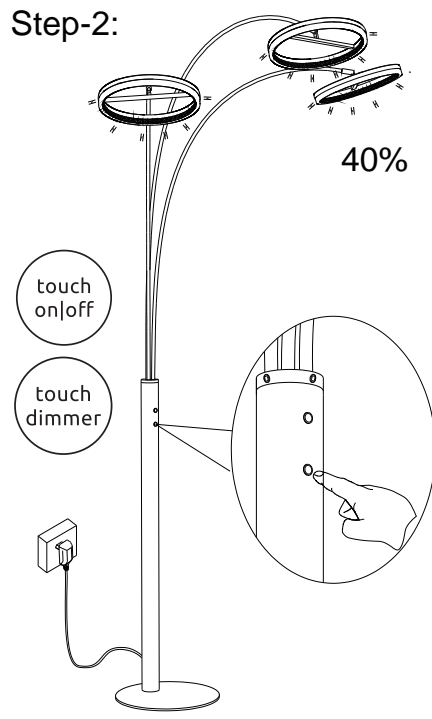
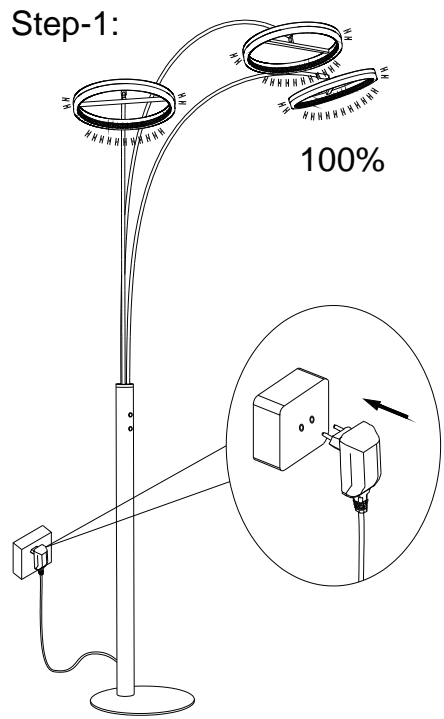

Lichtquelle/Light source:

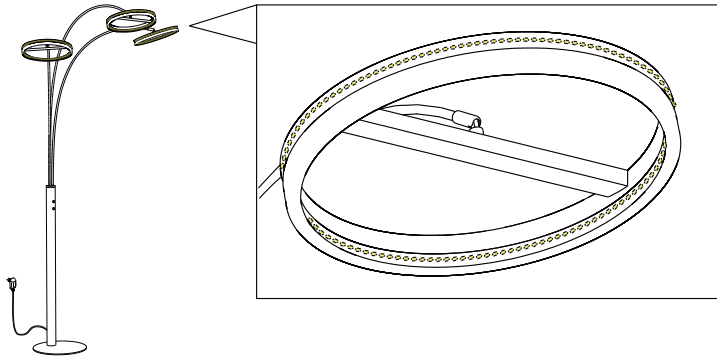

DEU:

Lichtquelle:

Die Lichtquelle ist nicht tauschbar, weil sie konstruktionsbedingt fest mit dem umgebenden Produkt verbunden ist. Dieses Produkt enthält eine Lichtquelle der Energieeffizienzklasse <F>.

  Die LED - Lichtquelle ist nicht austauschbar.

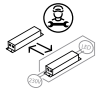



Das Betriebsgerät kann nur durch einen Fachmann ausgetauscht werden.

GBR:

Light source:

The light source is not interchangeable because it is determined by the surrounding product design. This product contains a light source of energy efficiency class <F>.

  The LED - light source cannot be replaced.

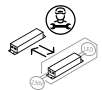



The control gear can be replaced by a professional.

BIH & HR:

Izvor svjetla :

Izvor svjetla nije zamjenjiv , jer je konstrukcijski pričvršćen na proizvod . Ovaj proizvod sadržava izvor svjetlosti klase energetske učinkovitosti <F>.

  LED – izvor svjetla nije moguće zamjeniti

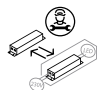



Pogonski uređaj smije zamjeniti samo stručna osoba.

BG:

Източник на светлина:

Източникът на светлина не може да се подменя, тъй като поради конструкцията си е трайно фиксиран към заобикалящия го продукт.

Този продукт включва светлинен източник с клас на енергийна ефективност <F>.

  LED източникът на светлина не може да се подменя.

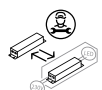



Устройството за управление може да се подменя само от специалист.

CZ:

Zdroj světla:

Světelný zdroj není možné vyměnit, protože je díky své konstrukci pevně spojený s produktem. Tento výrobek obsahuje světelný zdroj s třídou energetické účinnosti <F>.

  Světelný zdroj není vyměnitelný.

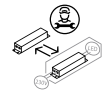

Výměna předřadníku pouze odborníkem.

DK:

Lyskilde:

Lyskilden kan ikke udskiftes, fordi den er fast forbundet med det omgivende produkt. Dette produkt indeholder en lyskilde i energieffektivitetsklasse < F >.

  LED- lyskilden kan ikke udskiftes.



Driftsenheden kan kun skiftes af en fagperson.

ET:

Valgusallikas:

Valgusallikas ei ole välja vahetatav, sest ta on tootega ehituslikult kindlalt seotud. Toode sisaldab energiatõhususe klassi <F> valgusallikat.

  LED - valgusallikat ei saa asendada.



Juhtseadmed võib asendada professionaalne.

FI:

Valonlähde:

Valonlähdettä ei voi vaihtaa uuteen, sillä se on rakenteellisesti yhdistetty ympäröivään tuotteeseen. Tämä tuote sisältää valonlähteen, jonka energiatehokkuusluokka on <F>.

  LED-valonlähdettä ei voi vaihtaa uuteen.



Vain ammattihenkilö voi vaihtaa liitäntälaitteen.

FR:**Source lumineuse:**

La source lumineuse n'est pas remplaçable car elle est, de par la construction du produit, liée de façon permanente à celui-ci.

Ce produit contient une source lumineuse de classe d'efficacité énergétique <F>.

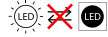

La source lumineuse LED n'est pas remplaçable.

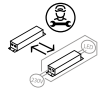

L'unité de contrôle ne peut être remplacée que par un spécialiste.

GR:**Φωτεινή πηγή:**

Η φωτεινή πηγή δεν μπορεί να αντικατασταθεί, επειδή είναι για κατασκευαστικούς λόγους σταθερά συνδεδεμένη με το προϊόν που την περιβάλλει.

Το προϊόν αυτό περιέχει φωτεινή πηγή της τάξης ενεργειακής απόδοσης <F>.

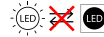

Η φωτεινή πηγή LED δεν αντικαθίσταται.

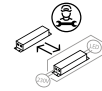

Η λειτουργική συσκευή μπορεί να αντικατασταθεί μόνο από έναν ειδικό.

HU:**Fényforrás:**

A fényforrás nem cserélhető, mert felépítése miatt szilárdan csatlakozik a termékhez.

Ez a termék egy <F> energiahatékonysági osztályú fényforrást tartalmaz.

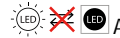

A fényforrás nem cserélhető.

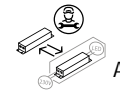

Az előtétet csak szakértők cserélhetik ki.

IS:**Ljósgjafi:**

Ljósgjafinn er ekki útskiptanlegur vegna þess að hann er háður umliggjandi hönnun vörunnar.

Varan inniheldur ljósgjafa í orkuflokkí <F>.

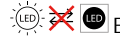

Ekki er hægt að skipta um LED-ljósgjafann.

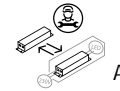

Aðeins fagmenn mega skipta um stjórnbúnaðinn.

IT:**Sorgente luminosa:**

La sorgente luminosa non è intercambiabile perché è saldamente collegata al prodotto per via del suo design.

Questo prodotto contiene una sorgente luminosa di classe di efficienza energetica <F>.

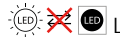

La sorgente luminosa a LED non può essere sostituita.

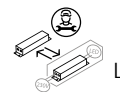

L'alimentatore può essere sostituito solo da personale specializzato.

LV:**Gaismas avots:**

Gaismas avotu nevar nomainīt, jo tas konstrukcijā ir cieši savienots ar izstrādājuma apkārtējo daļu.

Šis ražojums satur gaismas avotu, kura energoefektivitātes klase ir <F>.



LED apgaismes līdzekļi nevar nomainīt.

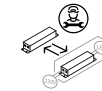

Vadības ierīci var nomainīt speciālists.

LT:**Šviesos šaltinis:**

Šis šviesos šaltinis yra nekeičiamas, nes jis prijungtas prie gaminio pagal jo konstrukciją.

Šiame gaminyje yra šviesos šaltinis, kurio energijos vartojimo efektyvumo klasė <F>.

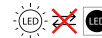

LED šviesos šaltinis yra nekeičiamas.

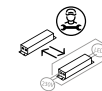

Valdymo įtaisą gali pakeisti tik tam kvalifikuotas specialistas.

NL:**Lichtbron:**

De lichtbron kan niet worden vervangen, omdat deze vanwege de constructie vast met het product eromheen verbonden is.

Dit product bevat een lichtbron van energie-efficiëntieklasse <F>.



De LED-lichtbron kan niet worden vervangen.

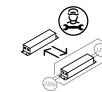

Het apparaat kan alleen door een vakman worden vervangen.

NO:**Lyskilde:**

Lyskilden kan ikke byttes fordi den sitter fast i produktet.

Dette produktet inneholder en lyskilde i energiklasse <F>.



LED-lyspæren kan ikke byttes.

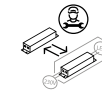

Driverenheten kan kun byttes av fagmann.

PL:**Źródło światła:**

Źródła światła nie można wymienić, ponieważ jest zintegrowane z produktem ze względu na swoją konstrukcję.

Ten produkt zawiera źródło światła o klasie efektywności energetycznej <F>.



LED - źródło światła nie może być wymienione.

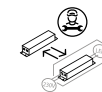

Urządzenie sterujące może zostać wymienione przez specjalistę.

PT:**Fonte de Luz:**

A fonte de luz não é substituível porque devido às suas características construtivas está fixada de forma permanente ao produto circundante.

Este produto contém uma fonte de luz da classe de eficiência energética <F>.

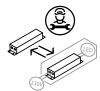

  Lâmpada não substituível.



Substituição do equipamento de controlo por um profissional.

RO:**Sursa de lumina:**

Sursa de lumina nu este inlocuibilă ea fiind parte constructivă a produsului. Acest produs conține o sursă de lumină cu clasa de eficiență energetică <F>.

  Sursa de lumina nu poate fi înlocuită.

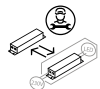

Driverul poate fi înlocuit doar de către personal specializat.

RUS:**Источник света:**

Источник света не является взаимозаменяемым, поскольку это определяется конструкцией смежного продукта. Данный продукт содержит источник света класса энергоэффективности <F>.

  Светодиодный источник света не подлежит замене.

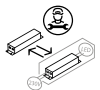



Устройство управления может заменяться только квалифицированным специалистом.

SRB:**Izvor svetlosti:**

Izvor svetlosti nije zamenljiv, jer je zbog svog dizajna čvrsto povezan sa proizvodom koji ga opkružuje.

Ovaj proizvod sadrži izvor svetlosti klase energetske efikasnosti <F>.

  LED izvor svetlosti nije zamenljiv.

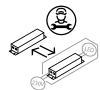



Upravljački uređaj može da zameni samo specijalista.

SK:**Zdroj svetla:**

Svetelný zdroj nie je možné vymeniť, pretože je vďaka svojej konštrukcii pevne spojený s produktom.

Tento výrobok obsahuje svetelný zdroj triedy energetickej účinnosti <F>.

  Svetelný zdroj nie je vymeniteľný.

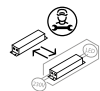



Výmena predradníka len odborníkom.

SI:**Izvor svetlobe:**

Vir svetlobe ni zamenljiv, ker je določen z zasnovo izdelka v okolici.

Ta izdelek vsebuje svetlobni vir razreda energijske učinkovitosti <F>.

  Svetlobni vir ni mogoče zamenjati.

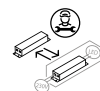

Krmilno napravo lahko zamenja samo strokovno usposobljena oseba.

ES:**Fuente de luz:**

La fuente de luz no es sustituible porque está fija en el producto desde la construcción.

Este producto contiene una fuente luminosa de la clase de eficiencia energética <F>.

  Bombilla no reemplazable.

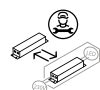

Sustitución del aparato por un profesional.

SE:**Ljuskälla:**

Ljuskällan är inte utbytbar, eftersom den på grund av konstruktionen är fast integrerad i den omgivande produkten. Denna produkt innehåller en ljuskälla med energieffektivitetsklass <F>.

  LED-ljuskällan kan inte bytas ut.

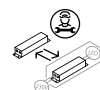



Driftdonet kan endast bytas ut av en fackman.

TR:**Işık kaynağı:**

Konstrüksiyon gereği çevreleyen ürün ile sabit bir şekilde bağlı olduğu için ışık kaynağı değiştirilemez.

Bu ürün, <F> enerji sınıfından bir ışık kaynağına sahiptir.

  LED ışık kaynağı değiştirilemez.

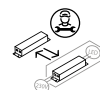



İşletme cihazı sadece bir uzman tarafından değiştirilebilir.

UK:**Джерело світла:**

Джерело світла не можна обміняти, оскільки воно міцно пов'язане з навколишнім виробом завдяки своїй конструкції.

Цей виріб містить джерело світла класу енергоефективності <F>.

  джерело світлодіодного світла не можна замінювати.

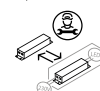

лише фахівець може замінювати пристрій керування.