

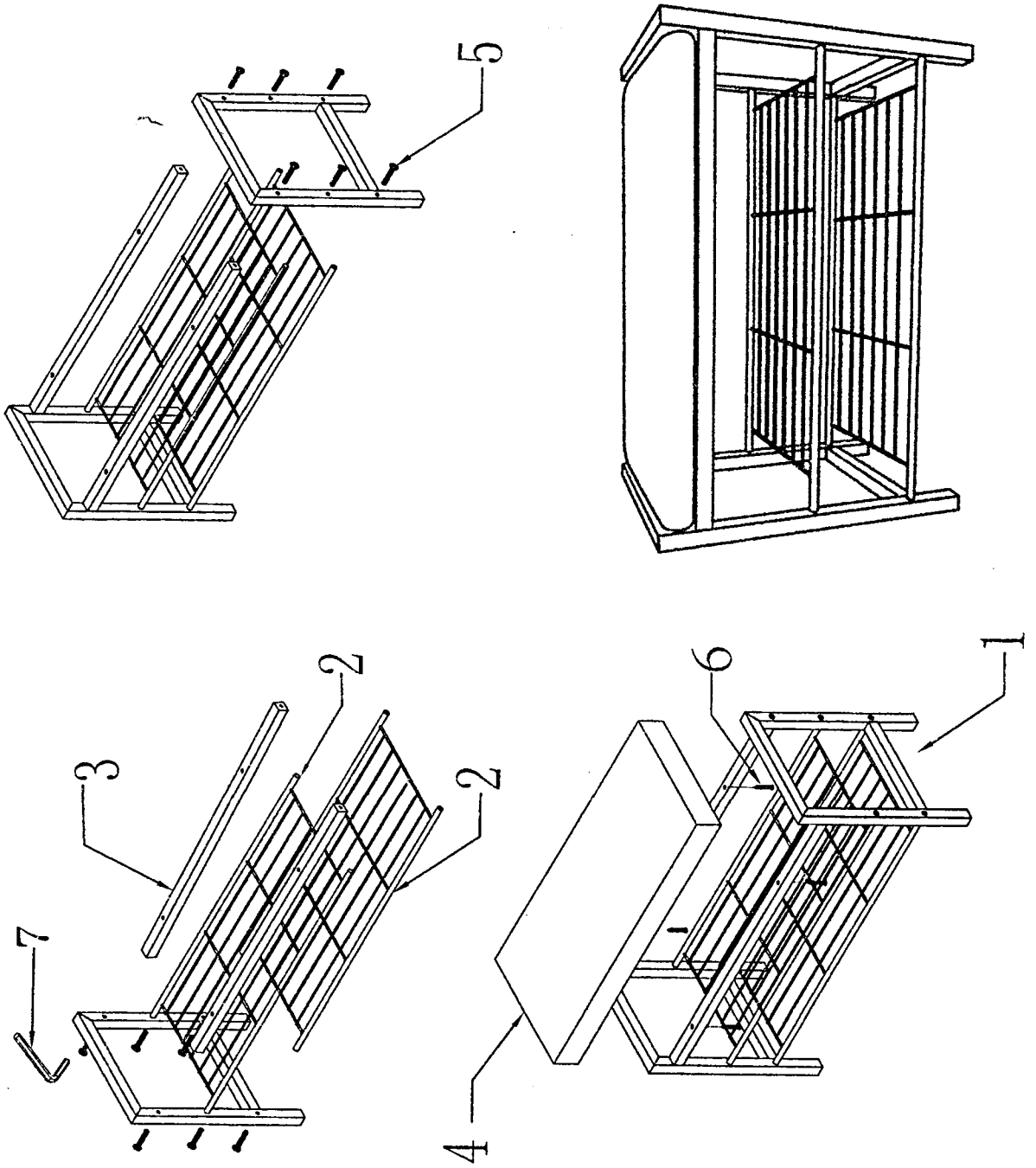

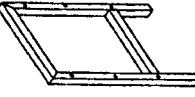

Pe 104220

54544

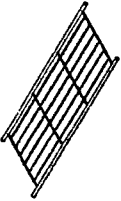
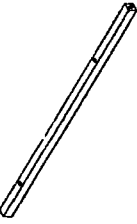
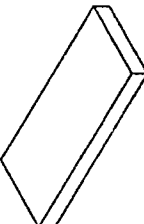

| NO. | FIGURE | QUANTITY |
|-----|---|----------|
| 1 |  | 2 |
| 2 |  | 2 |
| 3 |  | 2 |
| 4 |  | 1 |
| 5 |  M6x45 | 12 |
| 6 |  M4x40 | 4 |
| 7 |  | 1 |