

**D** MONTAGEANLEITUNG  
BEDIENUNGSANLEITUNG

**NL** HANDLEIDING VOOR DE MONTAGE  
GEBRUIKSAANWIJZING

**TR** MONTAJ TALIMATI  
KULLANIM KLAVUZU

**RO** INSTRUȚIUNI DE INSTALARE  
INSTRUȚIUNI DE UTILIZARE

**FR** NOTICE DE MONTAGE  
MANUEL INSTRUCTIONS

**HU** KÖZGYŰLÉS UTASÍTÁSOK  
KEZELÉSI UTASÍTÁS

**SI** NAVODILA ZA MONTAŽO  
NAVODILA ZA UPORABO

**ES** INSTRUCCIONES DE MONTAJE  
MANUAL DEL USUARIO

**GB** ASSEMBLY INSTRUCTIONS  
INSTRUCTION MANUAL

**PL** INSTRUKCJA MONTAŻU  
INSTRUKCJA OBSŁUGI

**RU** ИНСТРУКЦИЯ ПО МОНТАЖУ  
ИНСТРУКЦИЯ ПО ЭКСПЛУАТАЦИИ

**IT** ISTRUZIONI DI MONTAGGIO  
MANUALE DI ISTRUZIONI

**SK** MONTÁŽNY NÁVOD  
NÁVOD NA POUŽITIE

**CZ** MONTÁŽNÍ NÁVOD  
NÁVOD K POUŽITÍ

**PT** INSTRUÇÕES DE MONTAGEM  
MANUAL DO USUÁRIO

**HR** UPUTE ZA MONTAŽU  
UPUTE ZA UPOTREBU

**DOVER**  
**VITO TICONA**  
**TRENDY, SEATTLE**  
**ALPHA, BETA, OHIO, POLO**

**Service · Dienstverlening · Serwis · Servis · Сервисная служба · Serviciu · Services · Servizio · Servisný list · Szolgáltatás · Servisní list**

Name · Naam · Nazwa · İsim · Название · Nume · Nome ·  
Názov · Název · Název · Neve

Тур · Type · Tip · Тип · Tipo · Típus

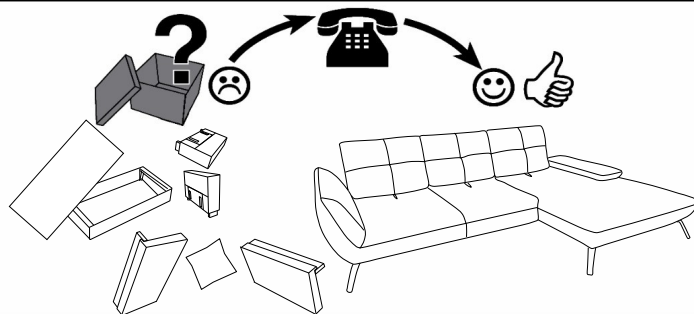
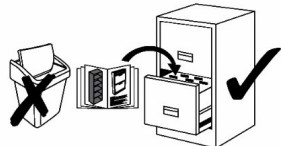





✓		 A a1	 B M6x25	 C	 D L4	 E 5L M8x30 e1	
			4 x A 4 x a1	16x	/	1x	/
	 2er		4 x A 4 x a1	16x	1x		/
	 3er		4 x A 4 x a1	16x	2x		/
			4 x A 4 x a1	16x	2x		/
	 MEGASOFA		4 x A 4 x a1	16x	1x		1 x E 1 x e1
			4 x A 4 x a1	16x	2x		/

Service · Dienstverlening · Serwis · Servis · Сервисная служба · Serviciu · Services · Servizio · Servisný list · Szolgáltatás · Servisní list

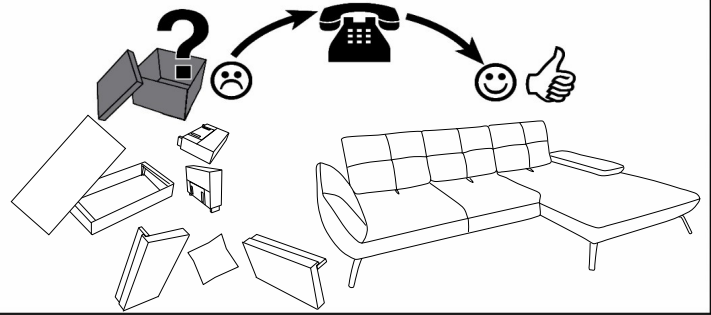
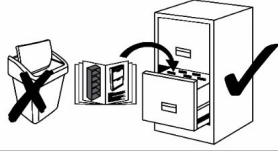
Name · Naam · Nazwa · İsim · Название · Nume · Nome ·  
Názov · Názov · Název · Neve

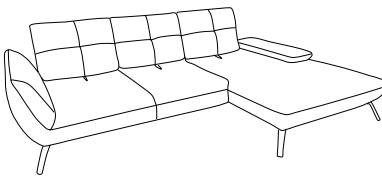
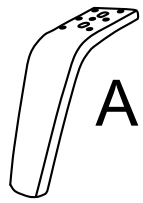
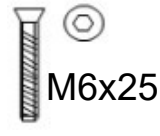
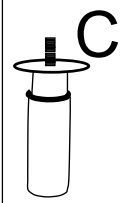
Тип · Type · Tip · Тип · Tipo · Típus

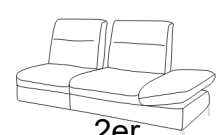
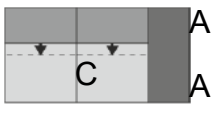
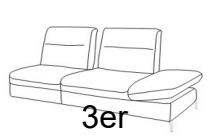
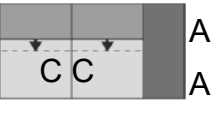

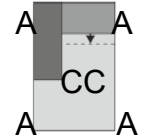
✓		 A a1	 B M6x25	 C	 D L4
	 2er	 A C A	2 x A 2 x a1	8x	1x
	 3er	 A C C A	2 x A 2 x a1	8x	2x
		 A A C C A A	4 x A 4 x a1	16x	2x

2er

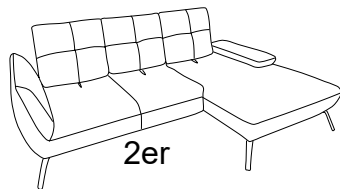

2er

3er

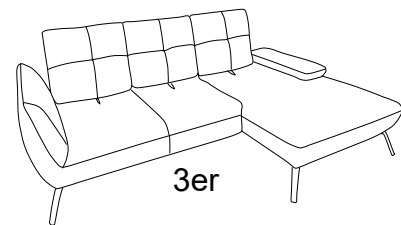

3er

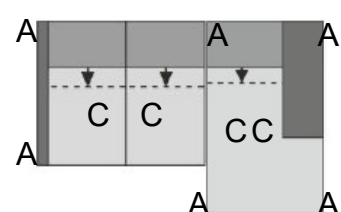
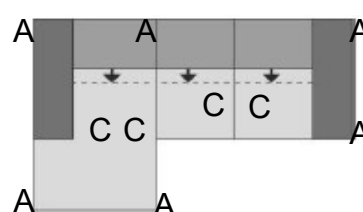
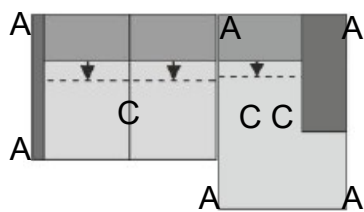
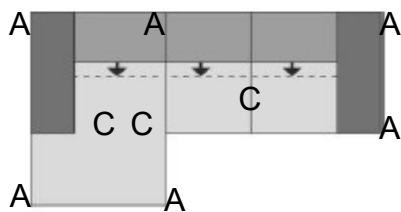







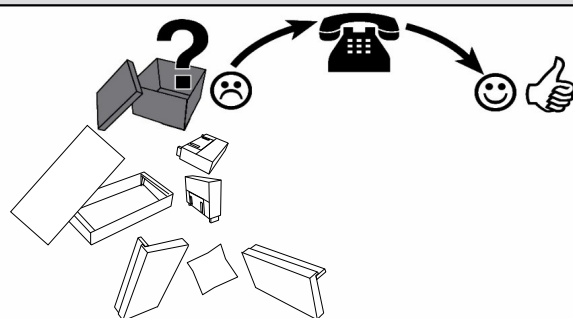
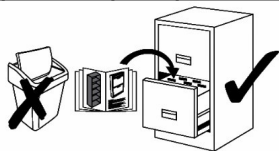

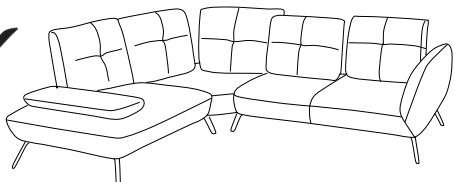
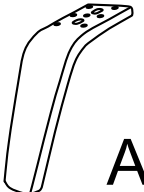

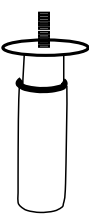

**Service · Dienstverlening · Serwis · Servis · Сервисная служба · Serviciu · Services · Servizio · Servisný list · Szolgáltatás · Servisní list**

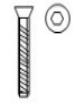
Name · Naam · Nazwa · İsim · Название · Nume · Nome ·  
Názov · Náзов · Název · Neve

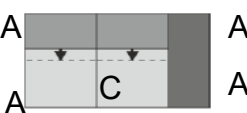
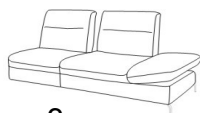
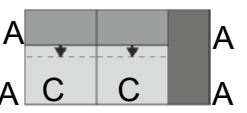
Тур · Туре · Tip · Тип · Тiро · Típus

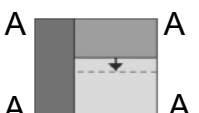
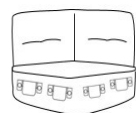
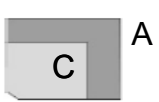
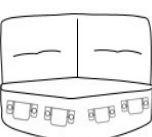
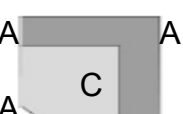

	 A a1	 B M6x25	 C	 D 4L	 E 5L	 F M8	 G M8x30	
 2er		4 x A 4 x a1	16x	1x				
 3er		4 x A 4 x a1	16x	2x				
		4 x A 4 x a1	16x	/				
		1 x A 1 x a1	4x	1x	1x	1x	4x	4x
		3 x A 3 x a1	3x4	1x	1x	1x	8x	8x
		4xA 4xa1	16x	1x				

C

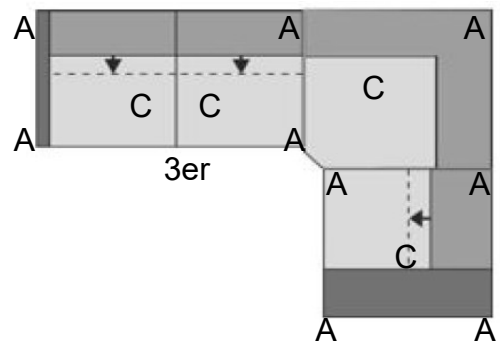
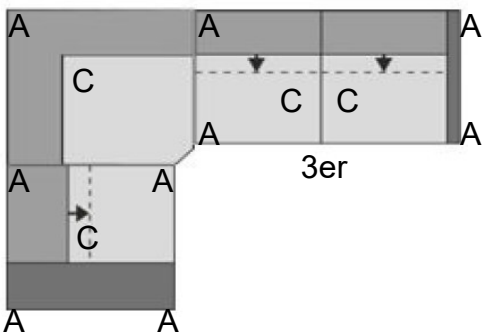
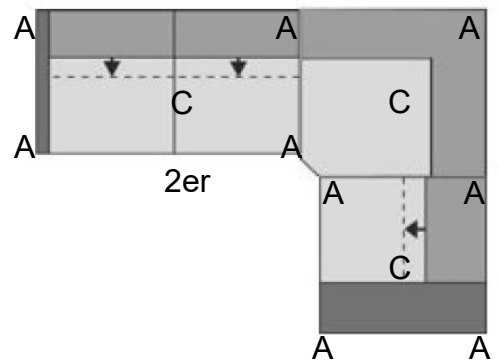
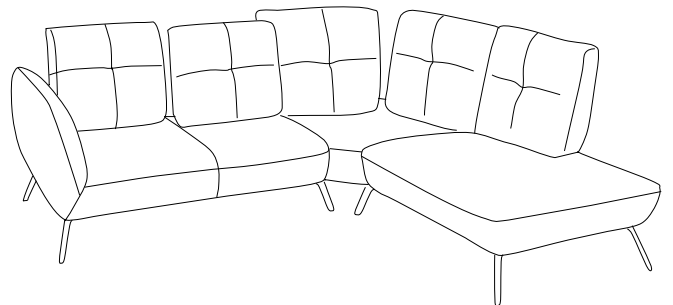
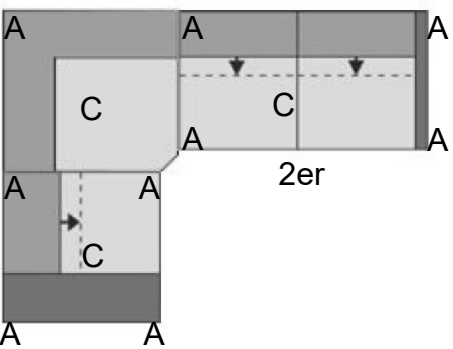
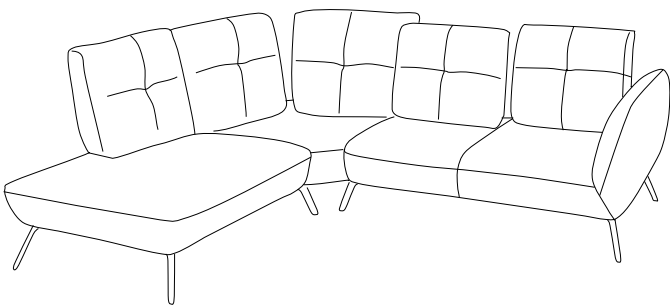
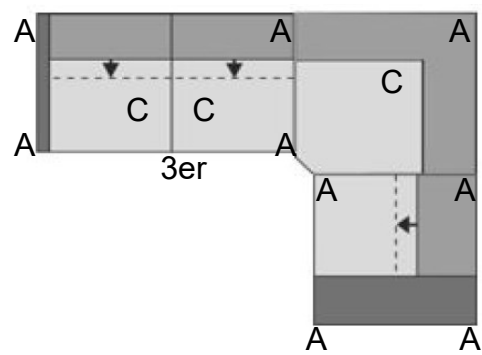
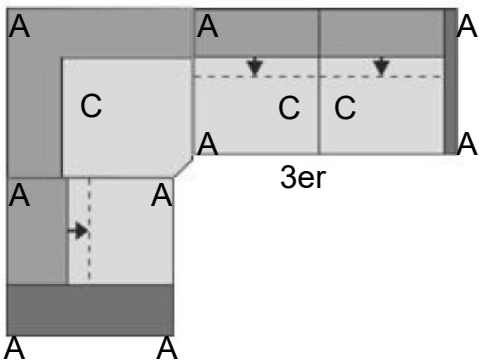
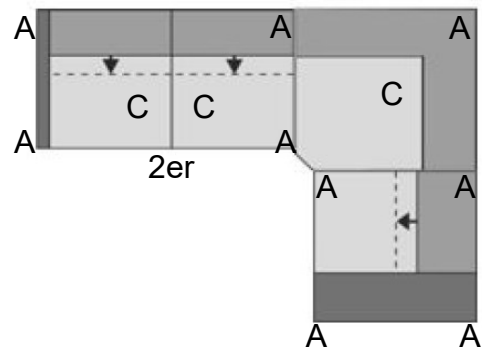
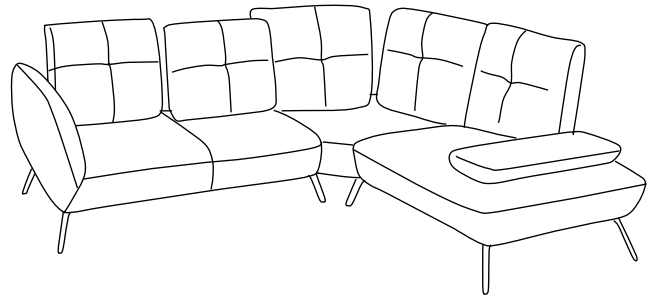
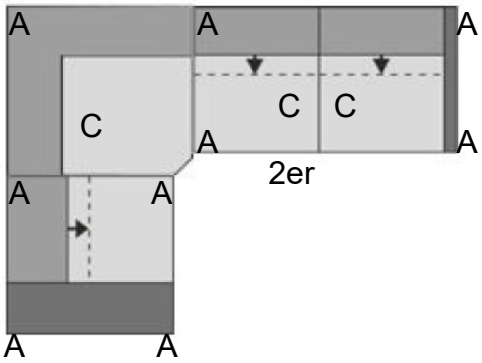
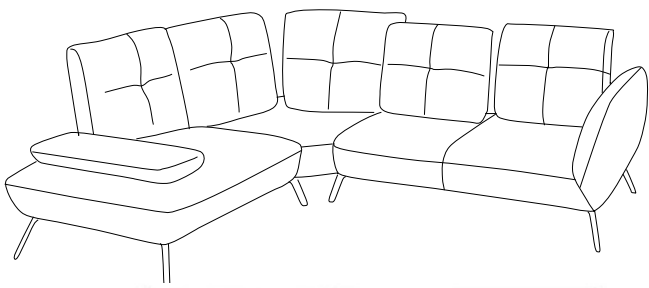







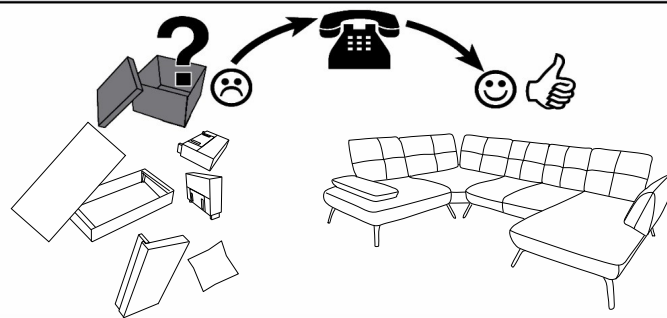
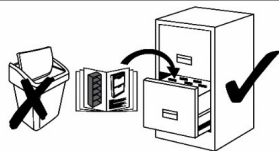

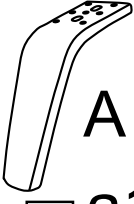
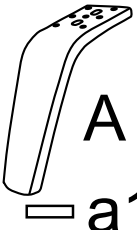
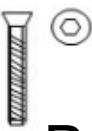



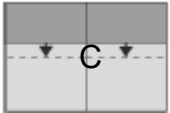

Service · Dienstverlening · Serwis · Servis · Сервисная служба · Serviciu · Services · Servizio · Servisný list · Szolgáltatás · Servisní list

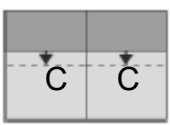
Name · Naam · Nazwa · İsim · Название · Nume · Nome ·  
Názov · Názov · Název · Neve

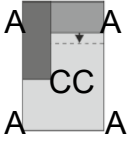
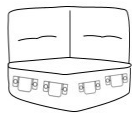
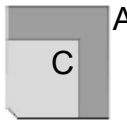
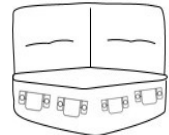
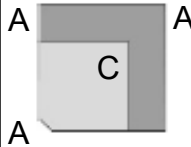
Тип · Type · Tip · Тип · Tipo · Típus

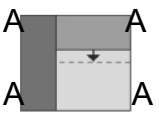

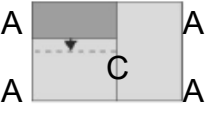
✓		 A a1	 B M6x25	 C	 D 4L	 E 5L	 F M8	 G M8x30	
	 2er	 A A C	2xA 2xa1	8x	1x				
	 3er	 A A C C	2xA 2xa1	8x	2x				
		 A A CC A	4xA 4xa1	16x	2x				
		 A C	1xA 1xa1	4x	1x	1x	1x	4x	4x
		 A A C A	3xA 3xa1	3x4	1x	1x	1x	8x	8x
		 A A A A	4xA 4xa1	16x	/				
		 A A C A	4xA 4xa1	16x	1x				

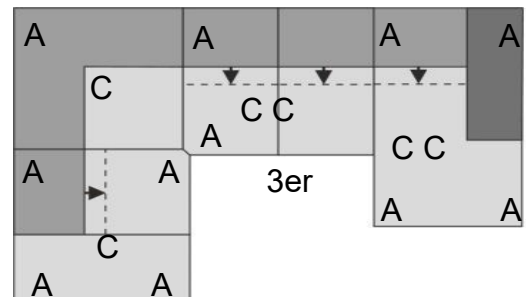
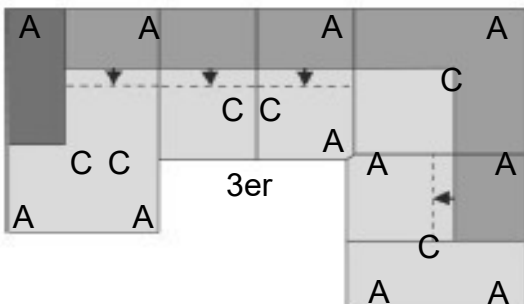
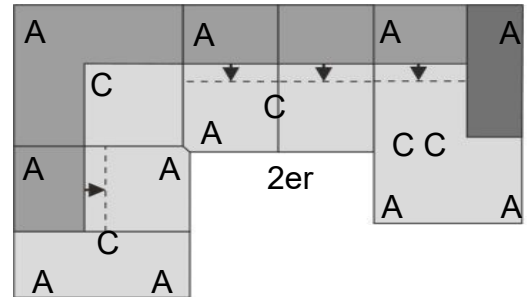
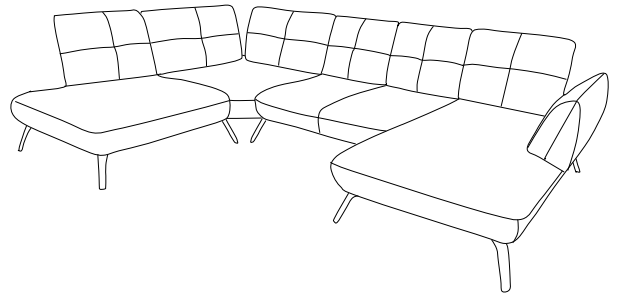
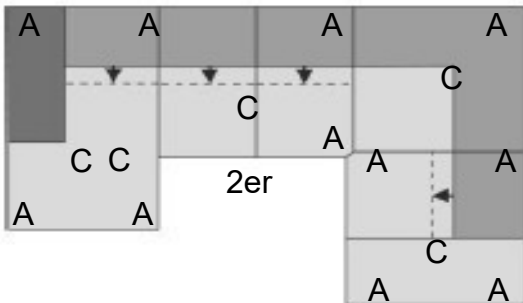
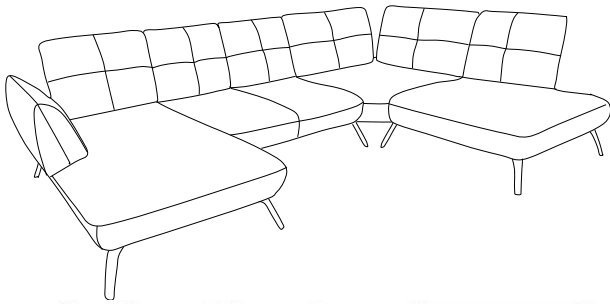
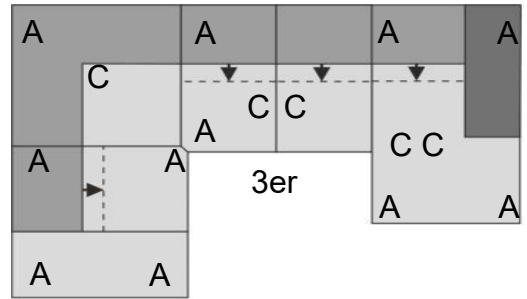
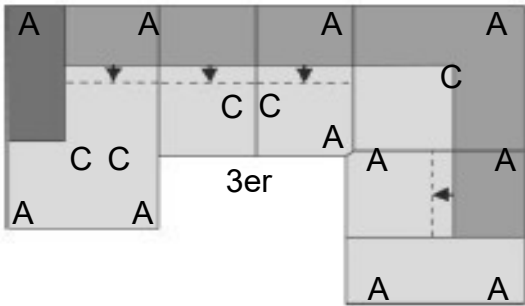
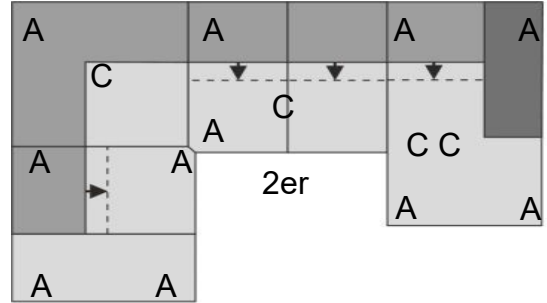
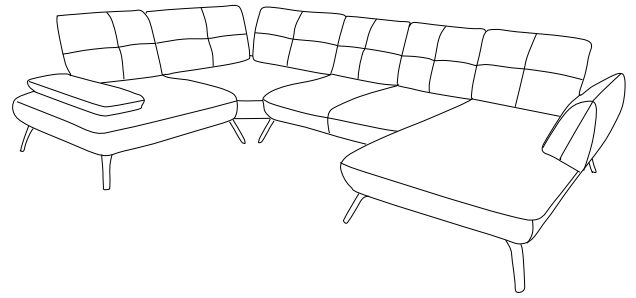
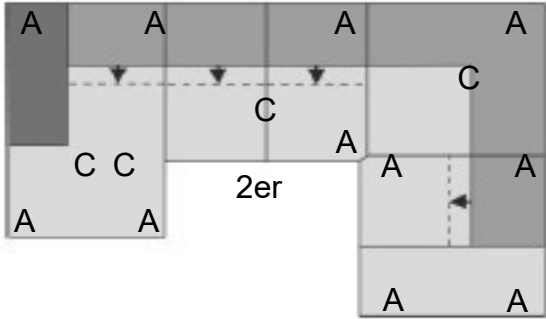
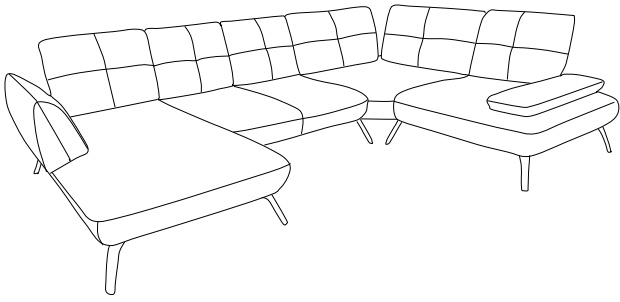

1

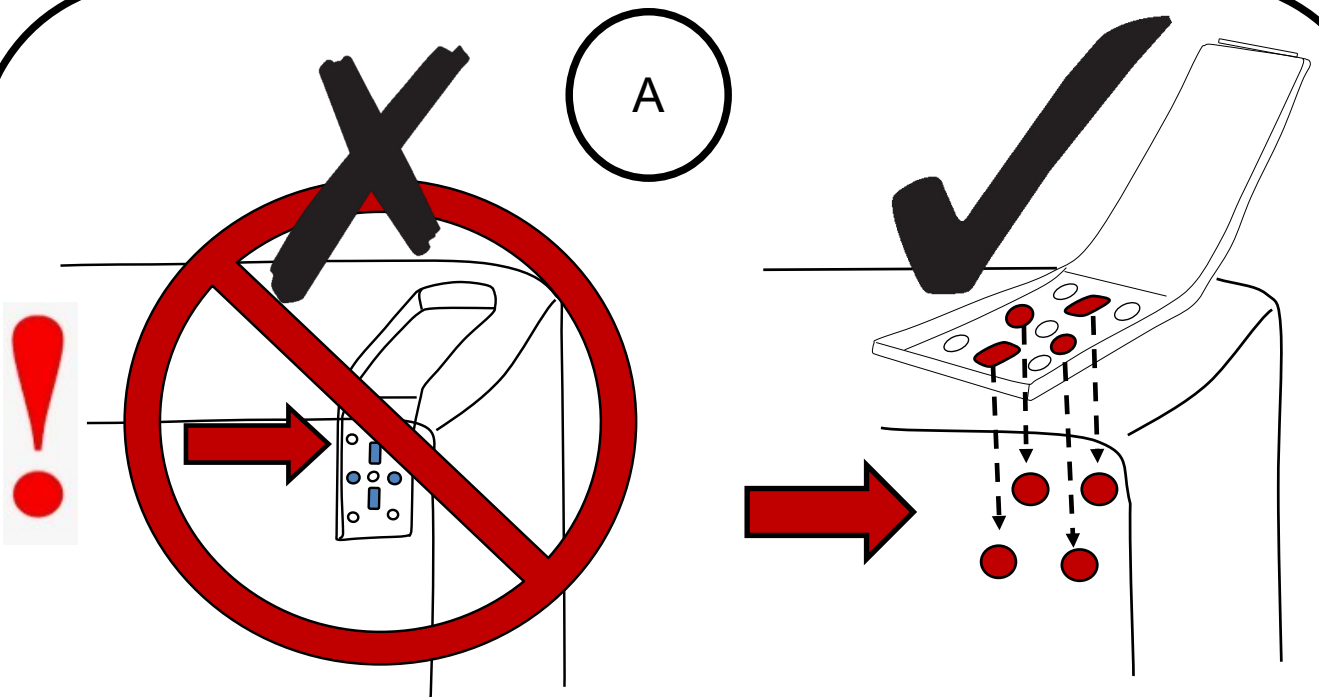
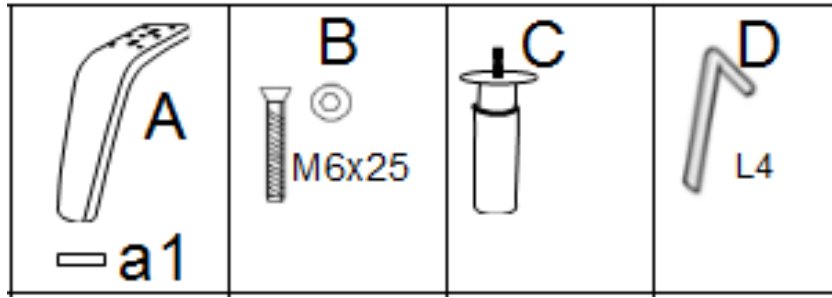
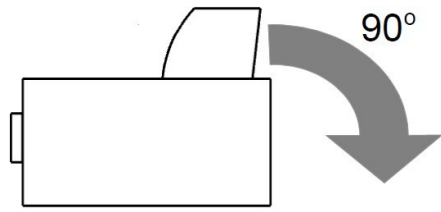

2

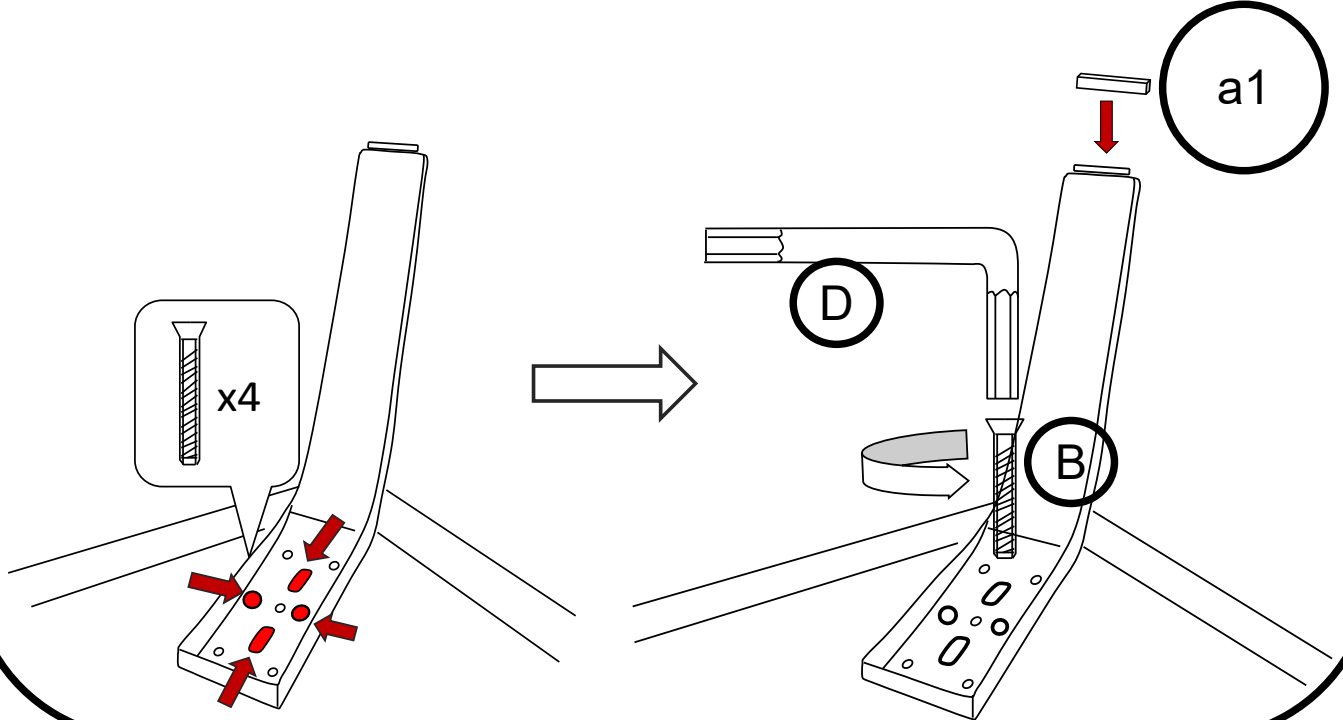



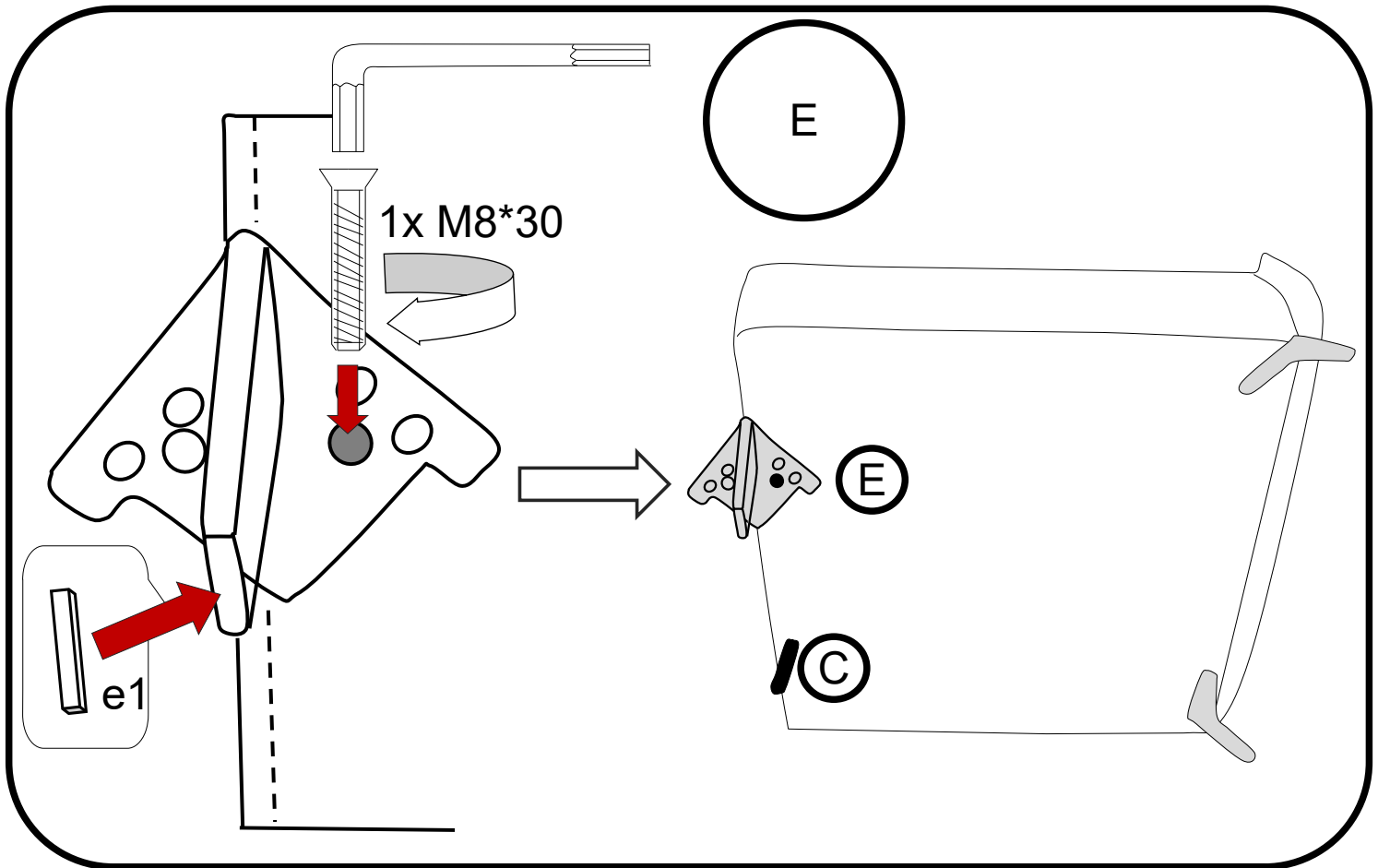
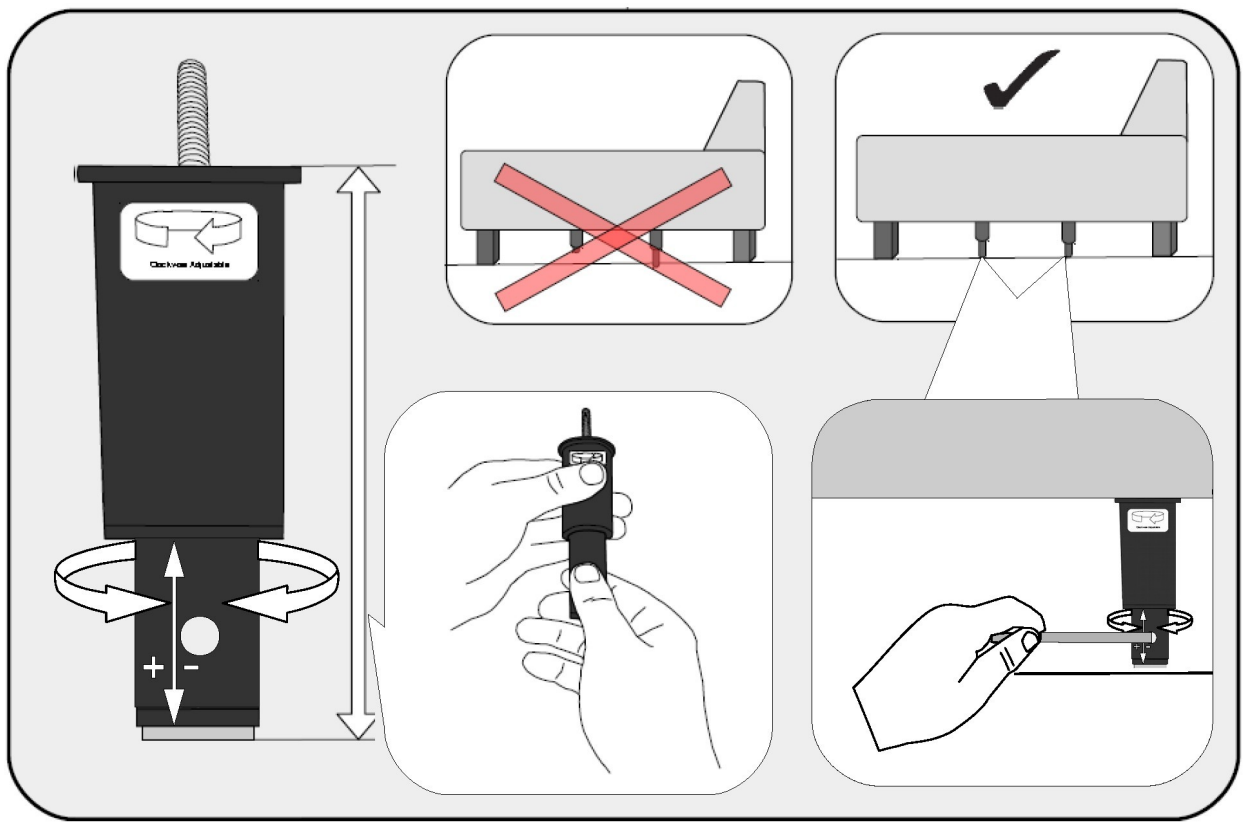

3

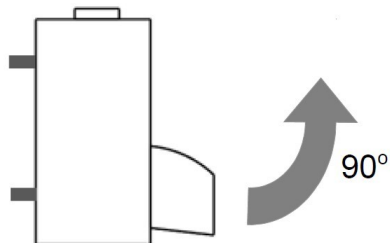

9

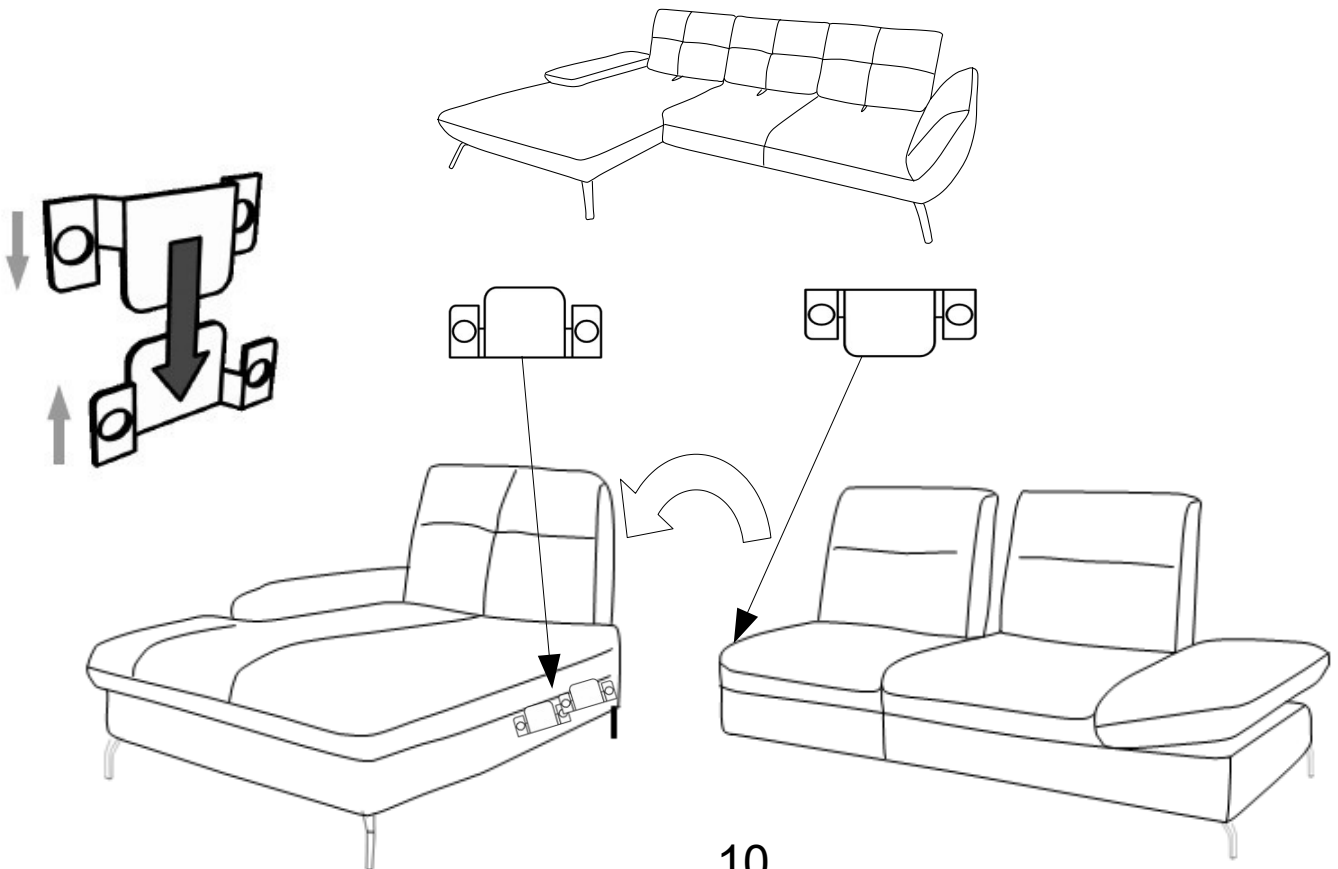
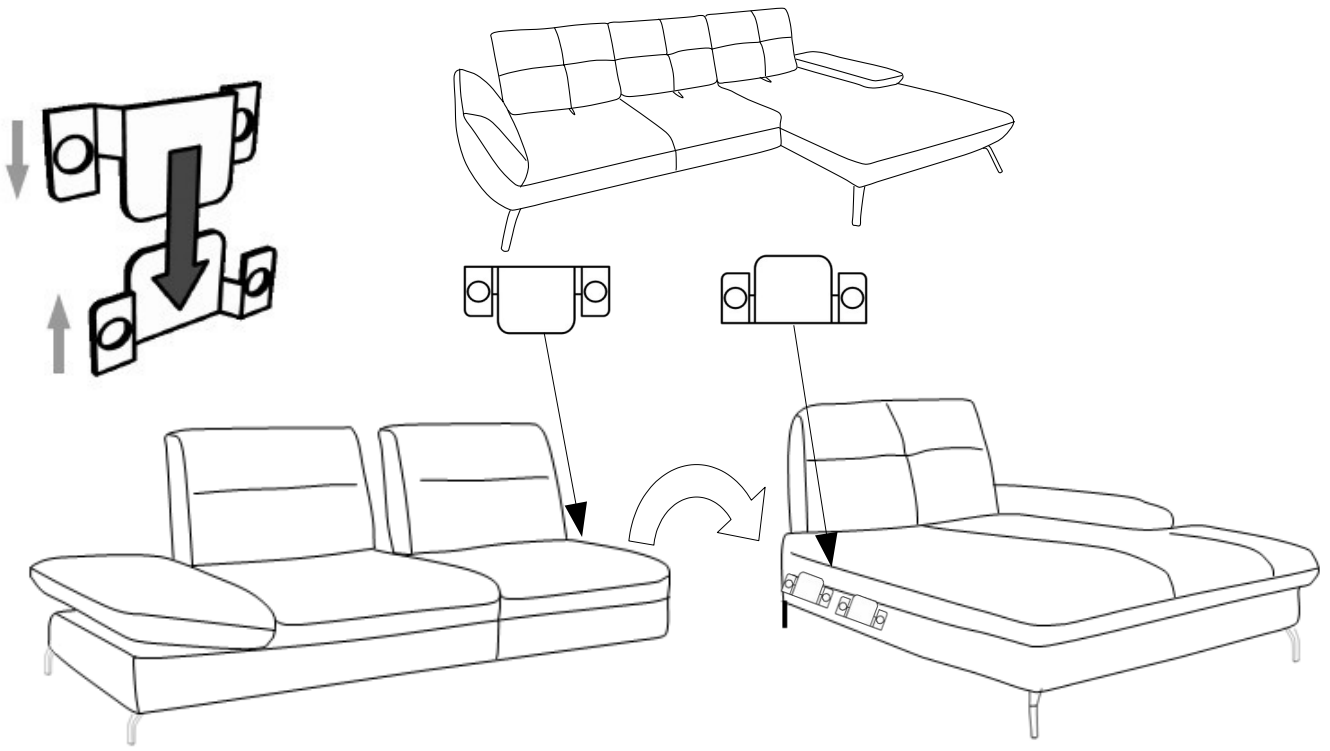

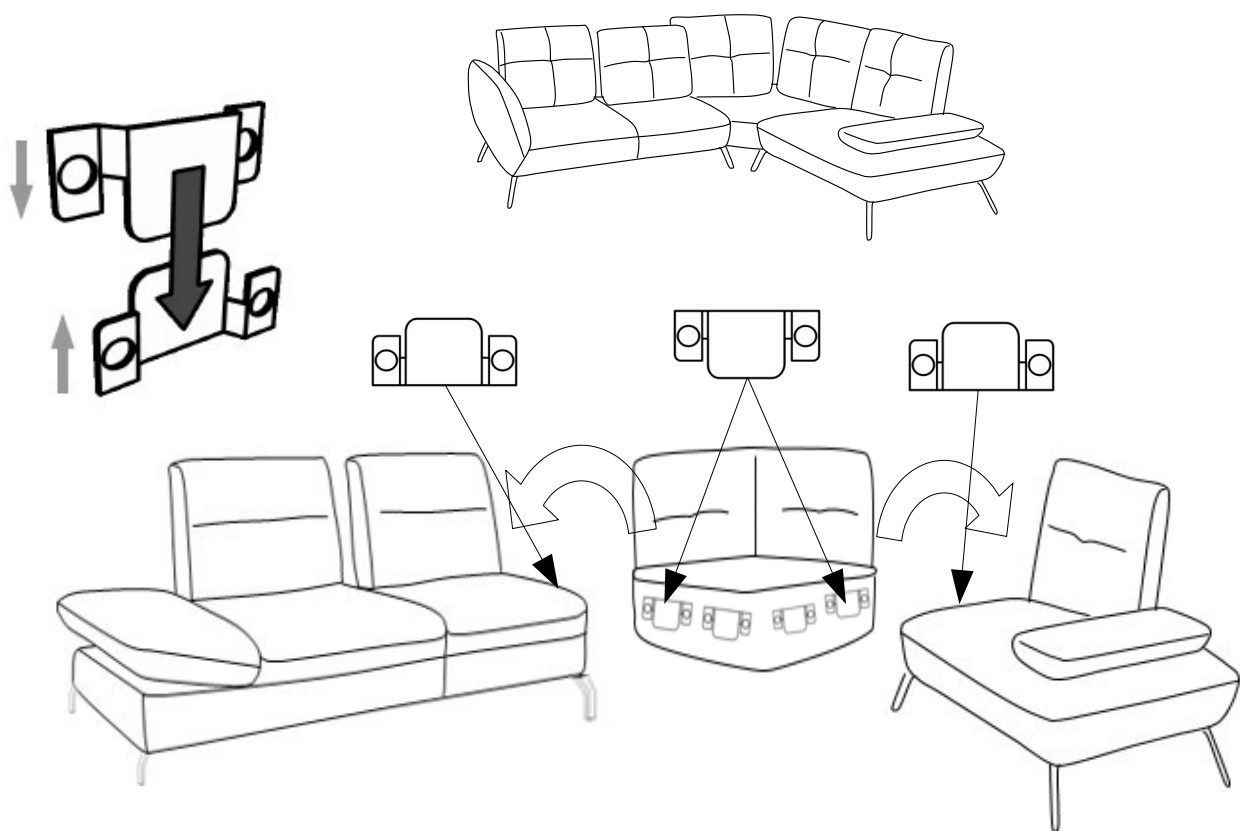
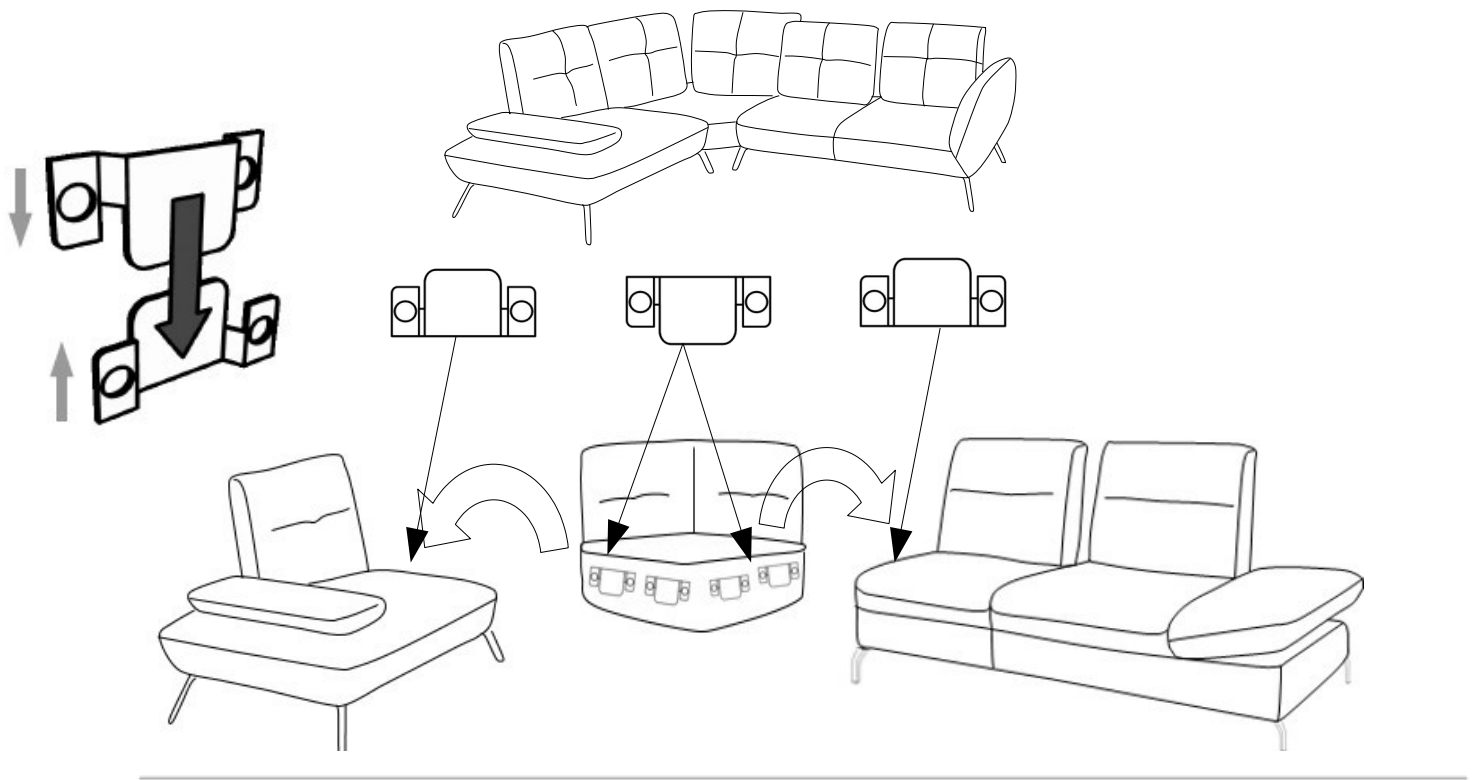

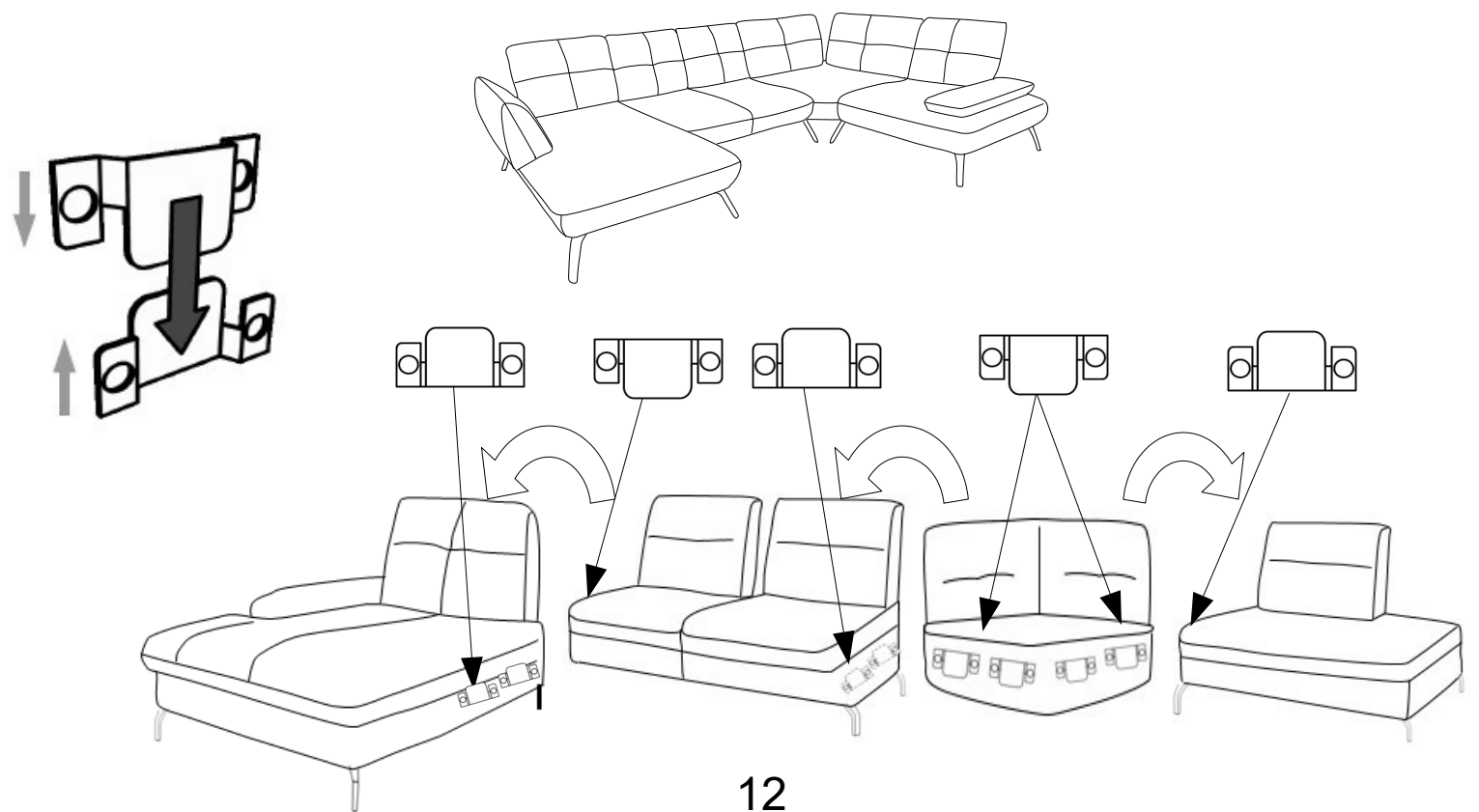
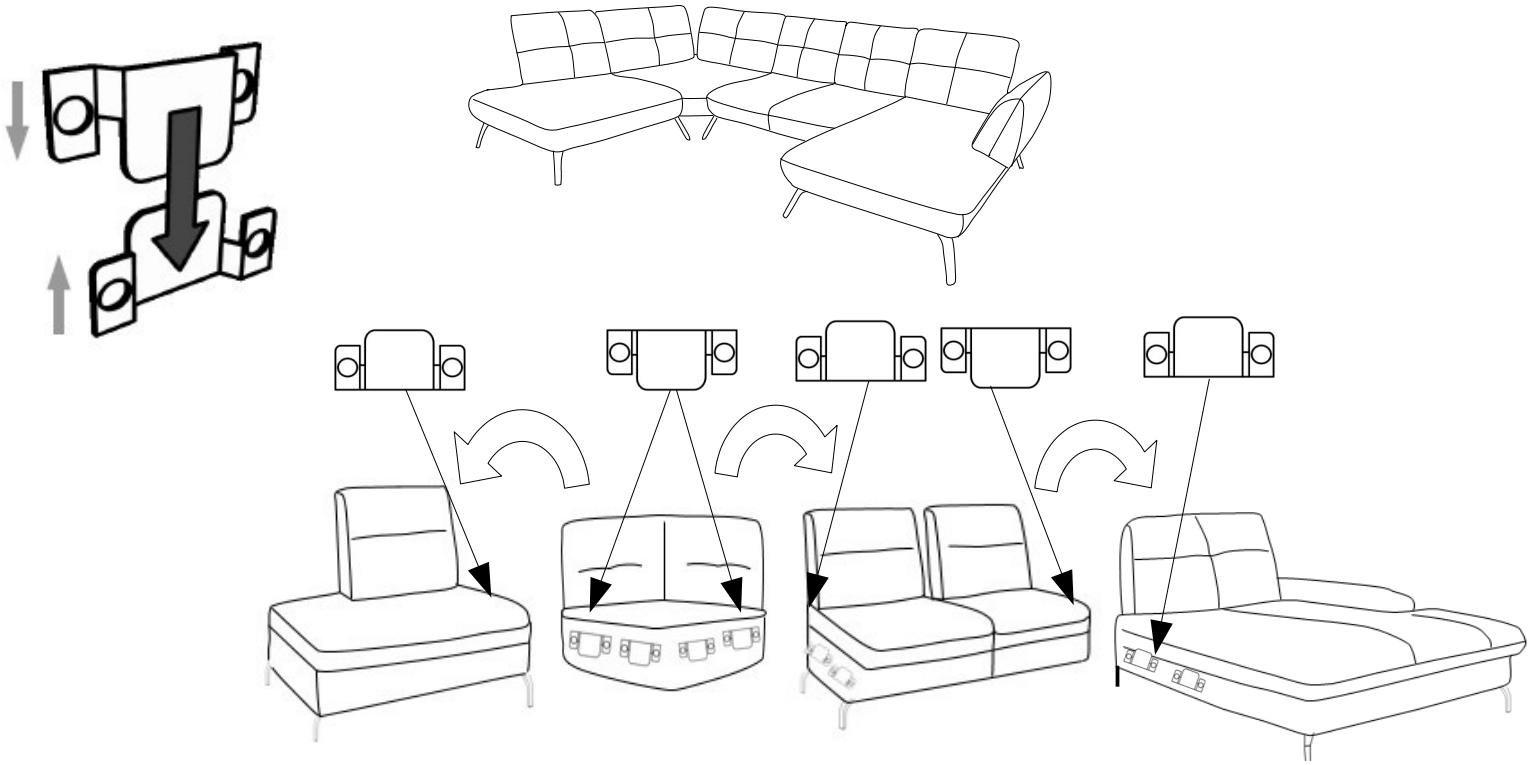

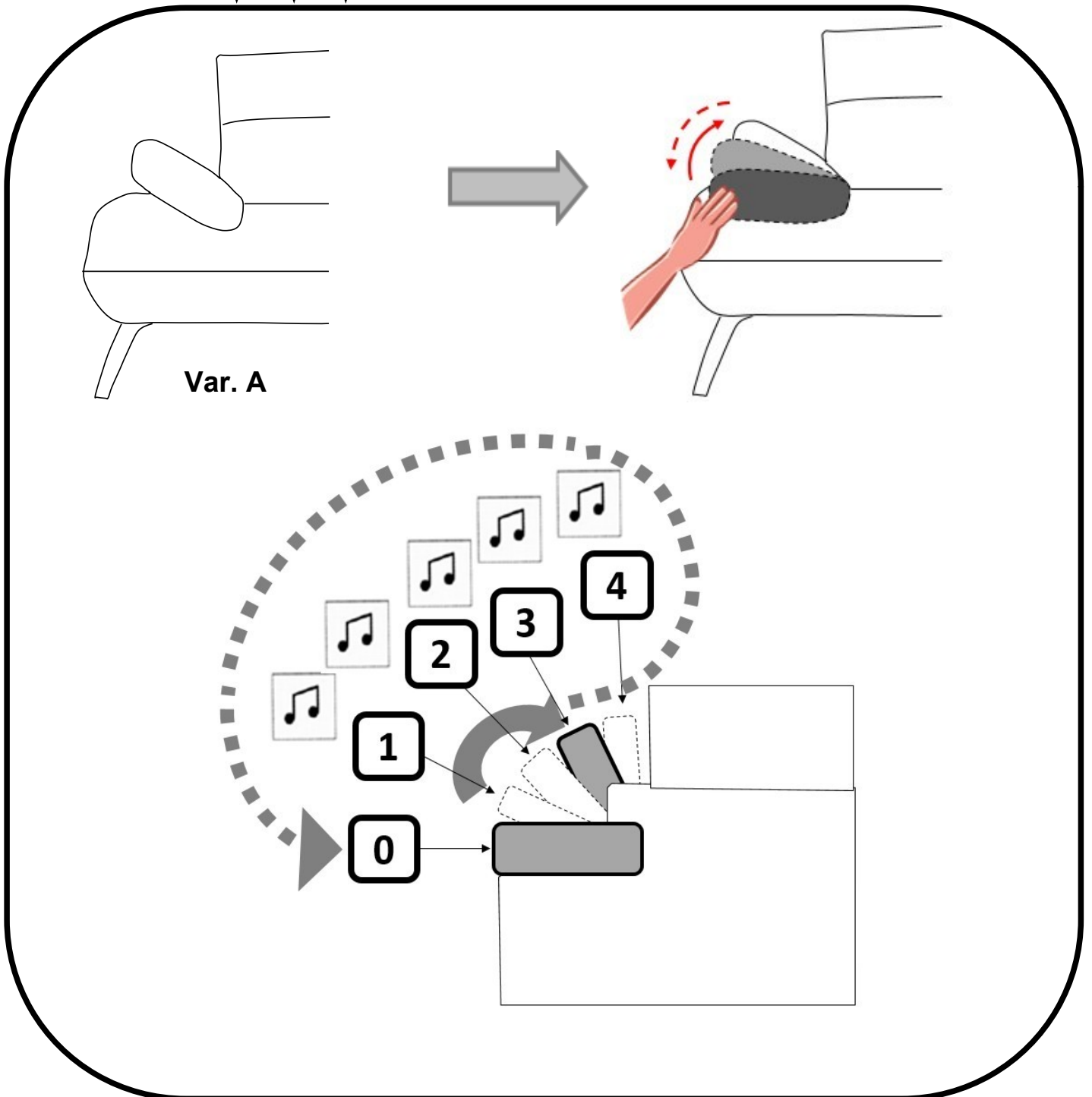
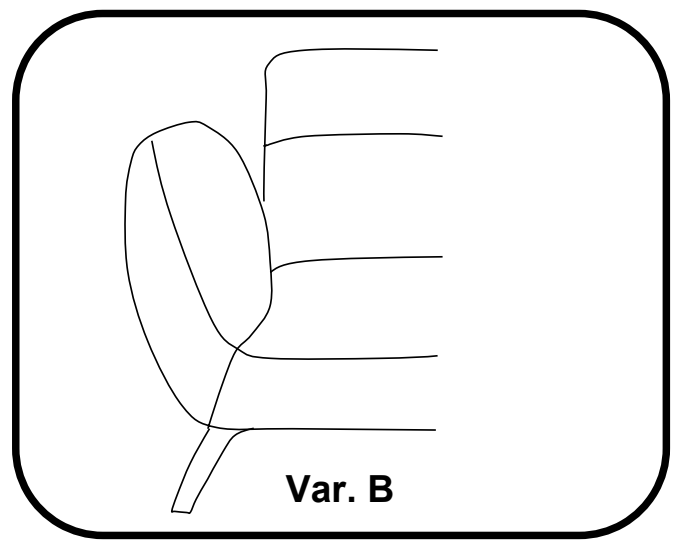
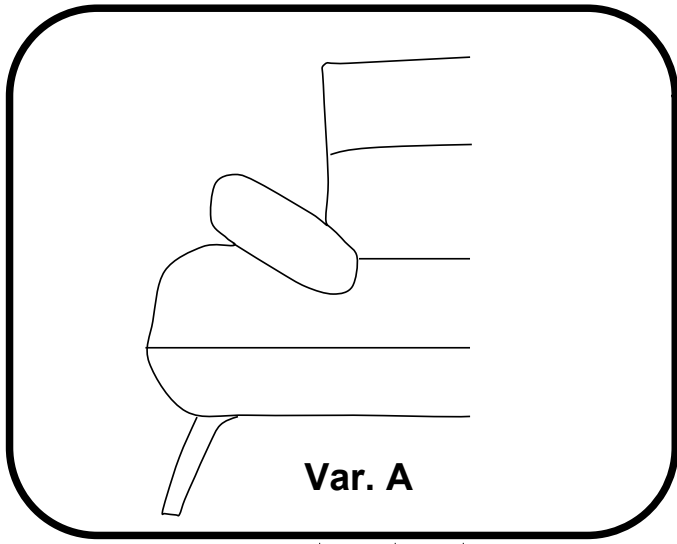

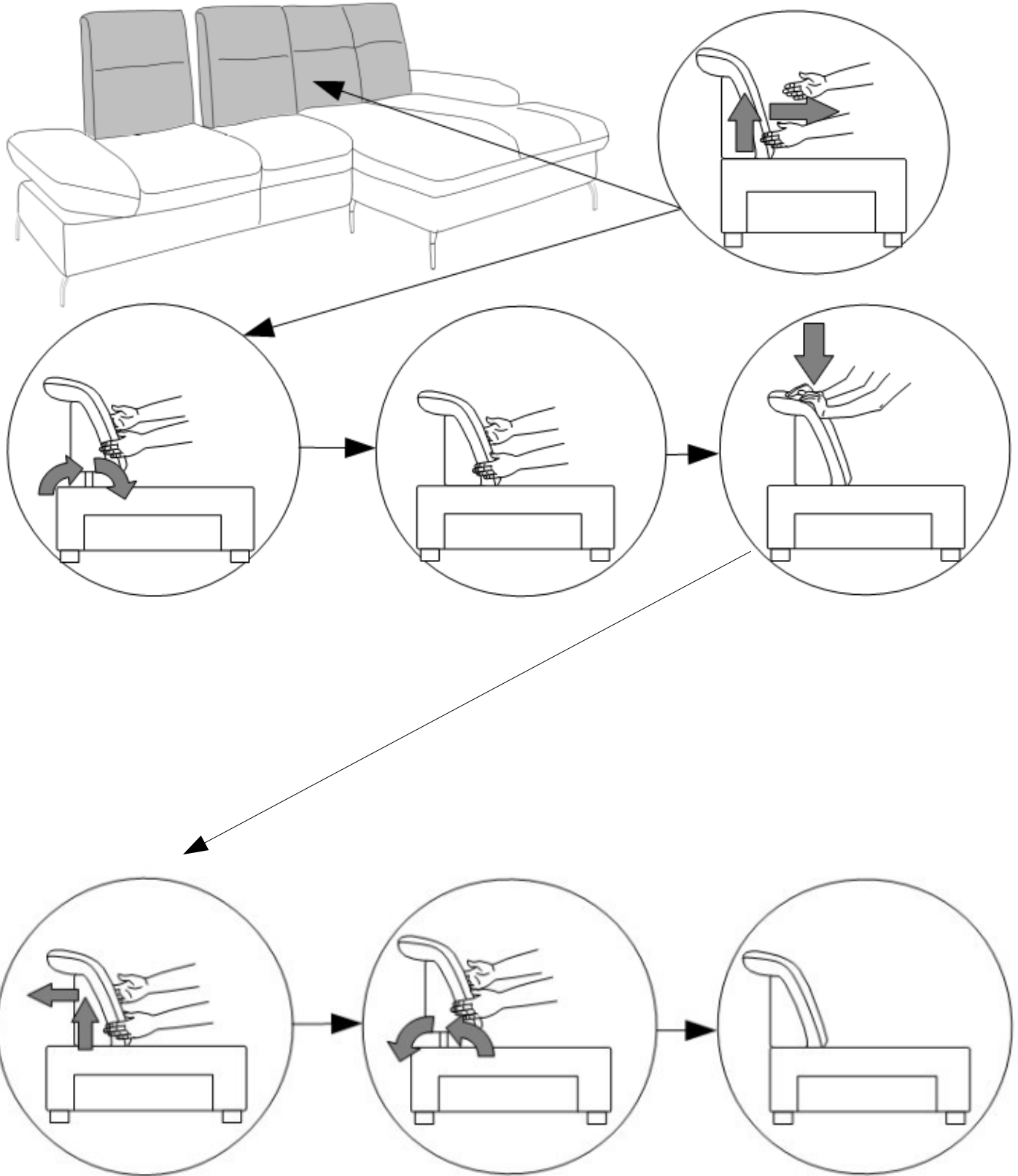
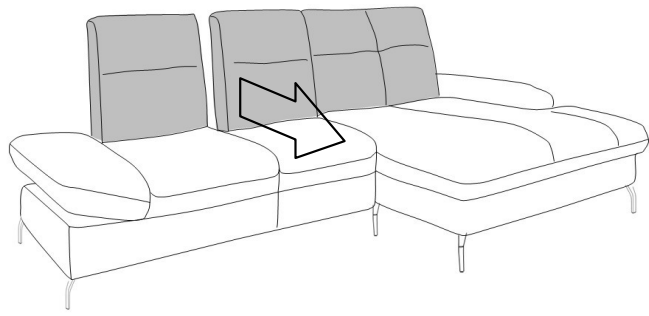

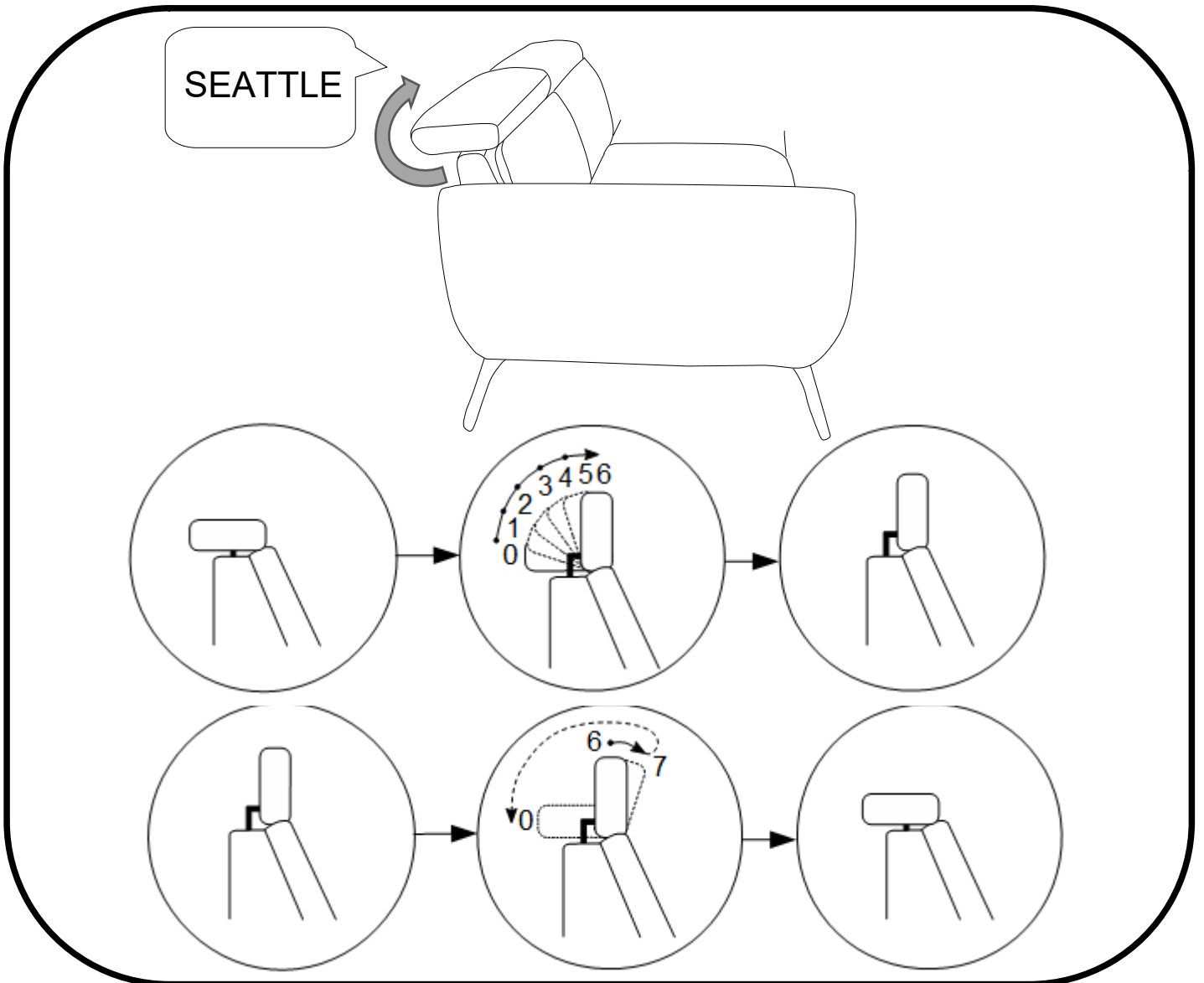
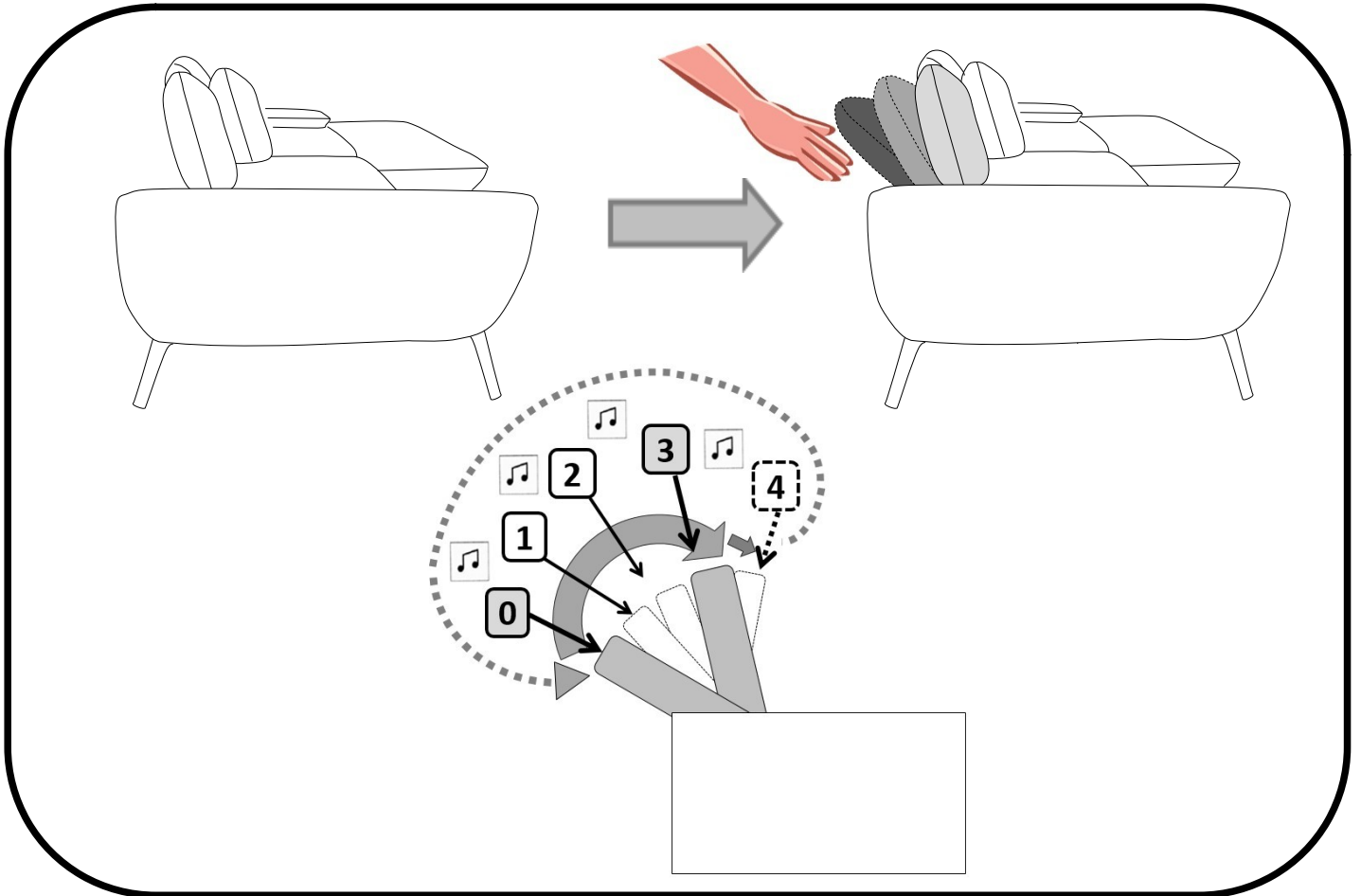

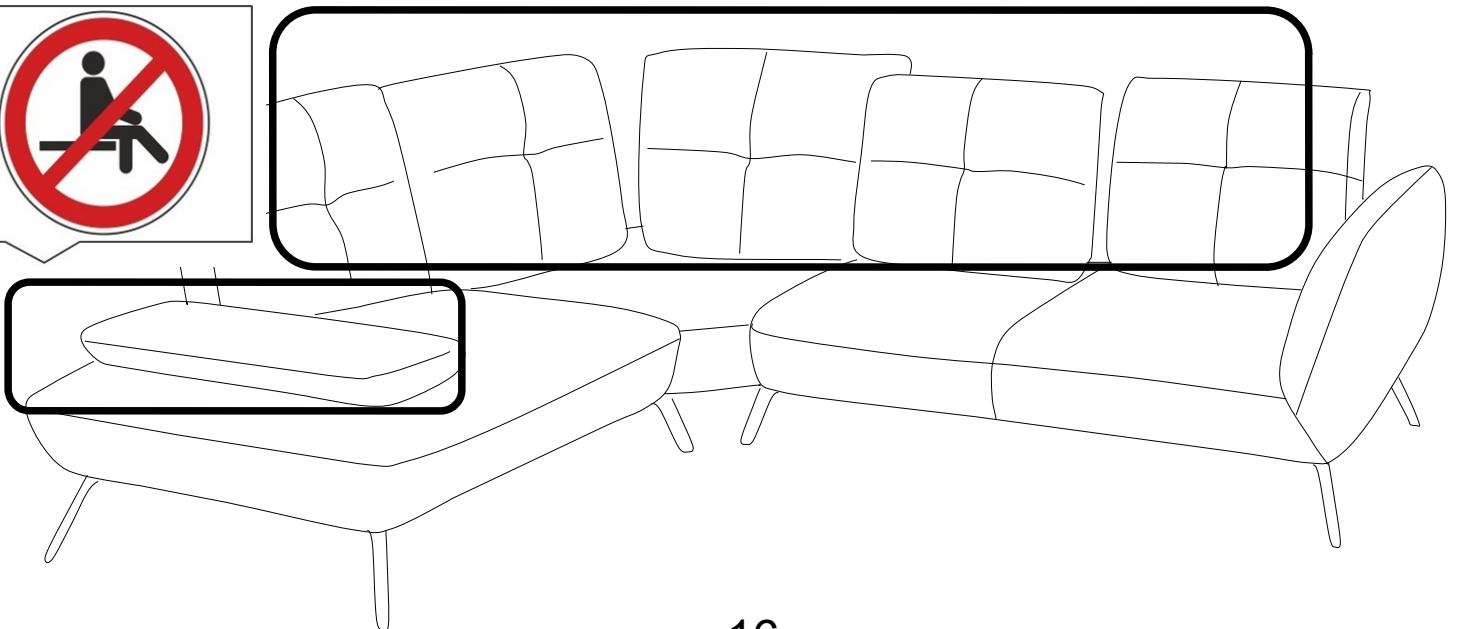
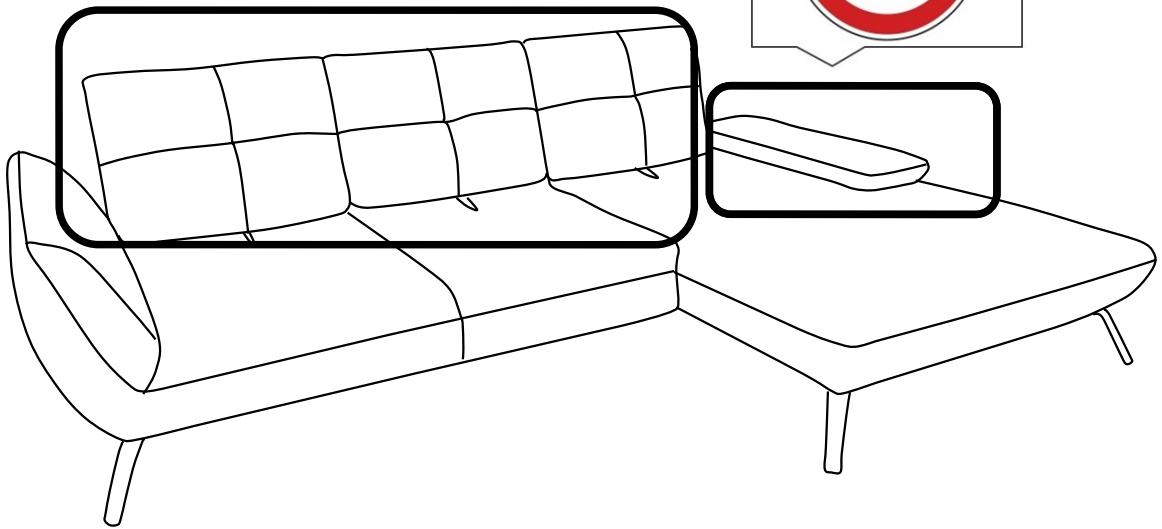
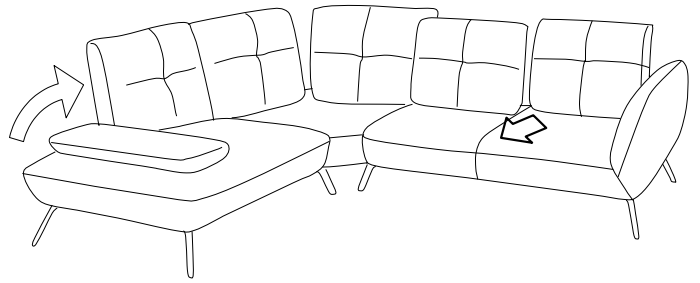
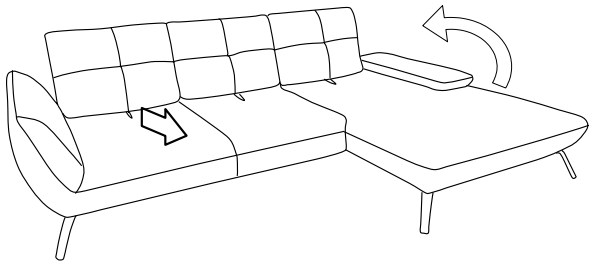



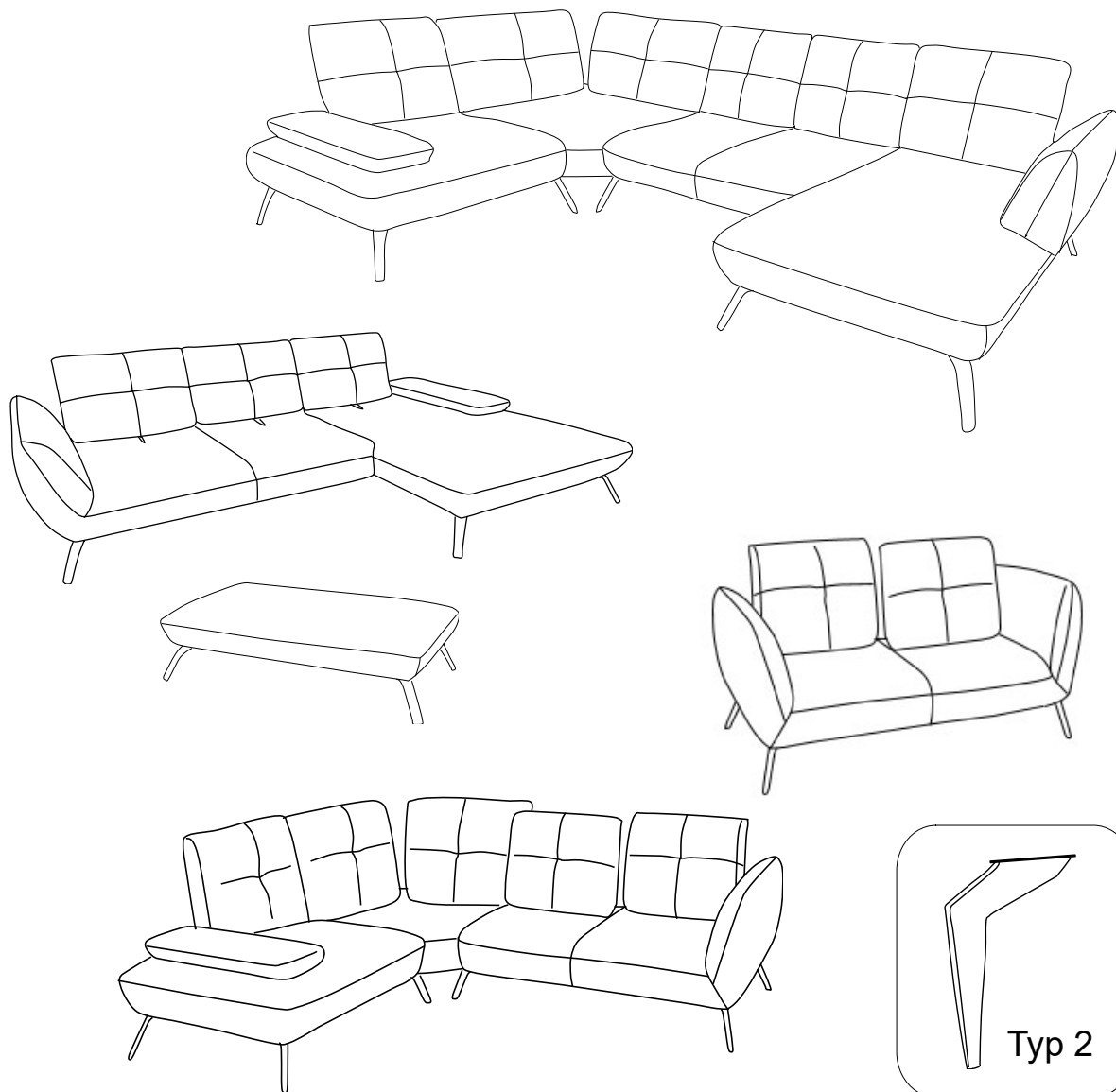

**VITO TICONA  
PAYTON**

**D** MONTAGEANLEITUNG  
BEDIENUNGSANLEITUNG

**NL** HANDLEIDING VOOR DE MONTAGE  
GEBRUIKSAANWIJZING

**TR** MONTAJ TALIMATI  
KULLANIM KLAVUZU

**RO** INSTRUCȚIUNI DE INSTALARE  
INSTRUCȚIUNI DE UTILIZARE

**FR** NOTICE DE MONTAGE  
MANUEL INSTRUCTIONS

**HU** KÖZGYŰLÉS UTASÍTÁSOK  
KEZELÉSI UTASÍTÁS

**SI** NAVODILA ZA MONTAŽO  
NAVODILA ZA UPORABO

**ES** INSTRUCCIONES DE MONTAJE  
MANUAL DEL USUARIO

**GB** ASSEMBLY INSTRUCTIONS  
INSTRUCTION MANUAL

**PL** INSTRUKCJA MONTAŻU  
INSTRUKCJA OBSŁUGI

**RU** ИНСТРУКЦИЯ ПО МОНТАЖУ  
ИНСТРУКЦИЯ ПО ЭКСПЛУАТАЦИИ

**IT** ISTRUZIONI DI MONTAGGIO  
MANUALE DI ISTRUZIONI

**SK** MONTÁŽNY NÁVOD  
NÁVOD NA POUŽITIE

**CZ** MONTÁŽNÍ NÁVOD  
NÁVOD K POUŽITÍ

**PT** INSTRUÇÕES DE MONTAGEM  
MANUAL DO USUÁRIO

**HR** UPUTE ZA MONTAŽU  
UPUTE ZA UPOTREBU

Service · Dienstverlening · Serwis · Servis · Сервисная служба · Serviciu · Services · Servizio · Servisný list · Szolgáltatás · Servisní list

Name · Naam · Nazwa · İsim · Название · Nume · Nome ·  
Názov · Názov · Název · Neve

Тур · Туре · Тір · Тип · Тіро · Típus

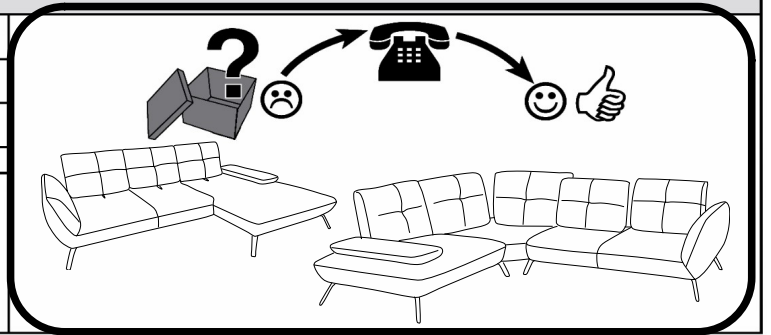
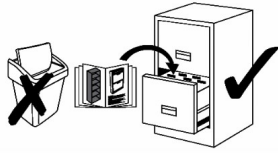

✓	Var. B		 A a1	 B M6x25	 C	 D 4L
 2er			4 x A 4 x a1	4x <b>3B</b>	1C	
 2er			2 x A 2 x a1	2x <b>3B</b>	1C	
 2er			4 x A 4 x a1	2x <b>3B</b> + 2x <b>4B</b>	1C	1D
 3er			4 x A 4 x a1	4x <b>3B</b>	2C	
 3er			2 x A 2 x a1	2x <b>3B</b>	2C	
 3er			4 x A 4 x a1	2x <b>3B</b> + 2x <b>4B</b>	2C	

✓

**Var. B**

**A**

**B**

M6x25

**C**

**D**

4L

**E**

5L

M8x30

a1

e1

**A** **A** (x3B) (x4B)

**A** **A** (x3B) (x4B)

4xA  
4xa1

2x**3B**  
+  
2x**4B**

/

/

**A** **A** (x3B) (x3B)

**A** **A** (x3B) (x3B)

2xA  
2xa1

2x**3B**

/

/

**A** **A** (x3B) (x4B)

**A** **C C** **A** (x3B) **C C** (x4B)

4xA  
4xa1

2x**3B**  
+  
2x**4B**

2C

1D

/

**A** **A** (x3B) (x3B)

**A** **C C** **A** (x3B) **C C** (x3B)

4xA  
4xa1

4x**3B**

2C

/

**A** **A**

**A** **C** **A**

**A** **E** **A**

4xA  
4xa1

4x**3B**

1C

1xE  
1xe1

**A** **A** x3B x3B

**A** **C** **A** x4B **C** 4xB

4xA  
4xa1

2x**3B**  
+  
2x**4B**

2C

/

Service · Dienstverlening · Serwis · Servis · Сервисная служба · Serviciu ·  
Services · Servizio · Servisný list · Szolgáltatás · Servisní list

Name · Naam · Nazwa · İsim · Название · Nume · Nome ·  
Názov · Názov · Název · Neve

Тур · Туре · Tip · Тип · Tiro · Típus

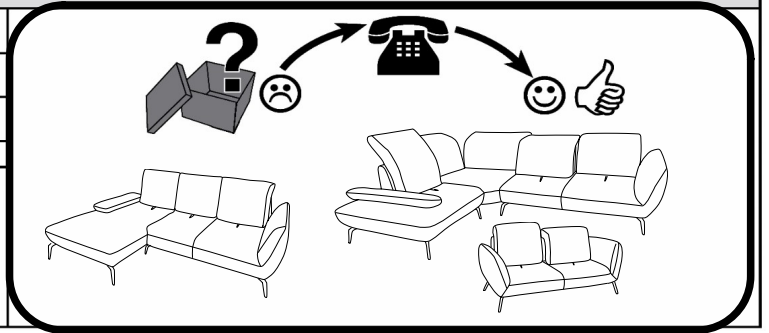
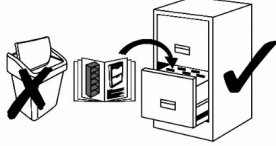









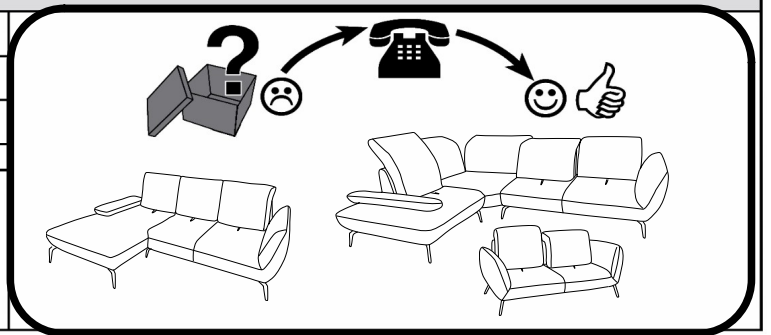
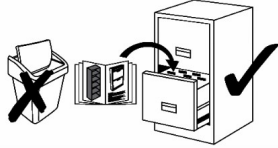

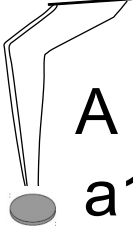
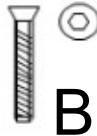
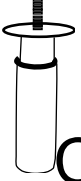

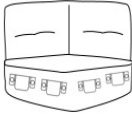
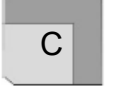
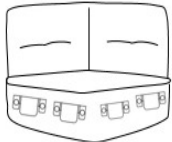

✓	Var. A		A a1	B M6x25	C	D 4L
			4 x A 4 x a1	4x4B	1C	1D
			2 x A 2 x a1	2x4B	1C	
			4 x A 4 x a1	4x4B	1C	
			4 x A 4 x a1	4x4B	2C	
			2 x A 2 x a1	2x4B	2C	
			4 x A 4 x a1	4x4B	2C	
			4 x A 4 x a1	4x4B	/	
			2 x A 2 x a1	2x4B	/	
			4 x A 4 x a1	4x4B	2C	

Service · Dienstverlening · Serwis · Servis · Сервисная служба · Serviciu ·  
Services · Servizio · Servisný list · Szolgáltatás · Servisní list

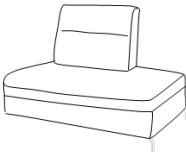
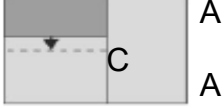
Name · Naam · Nazwa · İsim · Название · Nume · Nome ·  
Názov · Názov · Název · Neve

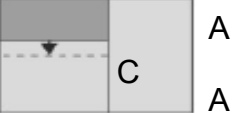
Тур · Туре · Tip · Тип · Típo · Típus

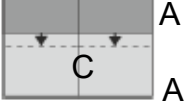

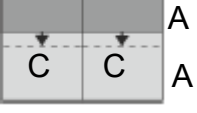
✓			 A a1	 B M6x25	 C	 D 4L	 E 5L	 F M8	 G M8x30
		A  A A	4 x A 4 x a1	4x4B	/	1D			
		C  A	1 x A 1 x a1	1x4B	1C	1D	1E	4xF	4xG
		A  A A	3 x A 3 x a1	3x4B	1C	1D	1E	8xF	8xG
		A  A A	4 x A 4 x a1	4x4B	1C	1D			
		 A A	2 x A 2 x a1	2x4B	1C	1D			
	 2er	 A A	2 x A 2 x a1	2x4B	1C	1D			
	 3er	 A A	2 x A 2 x a1	2x4B	2C	1D			

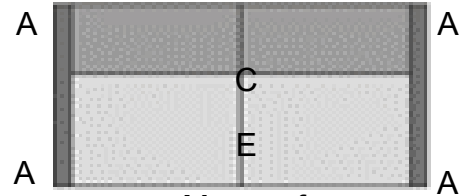
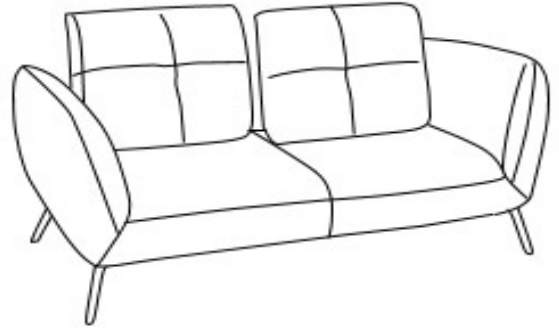
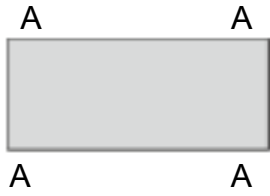
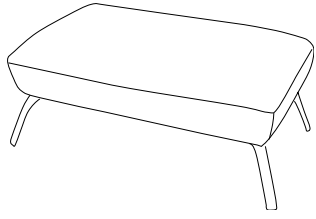

Megasofa

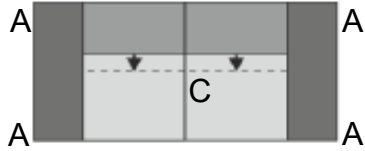
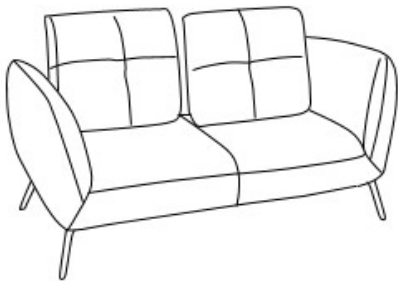

2er

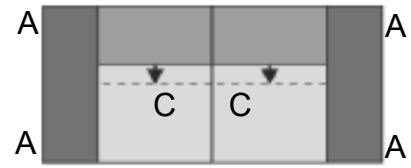
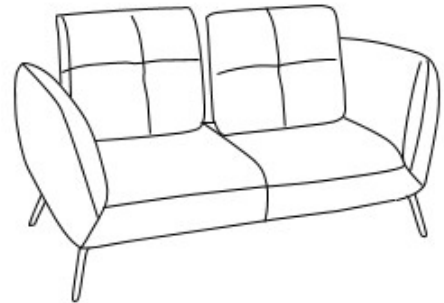

3er

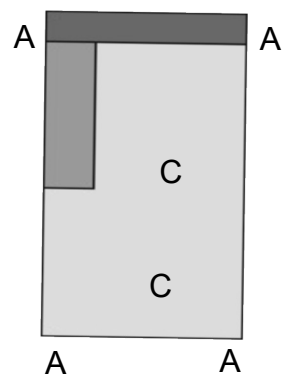
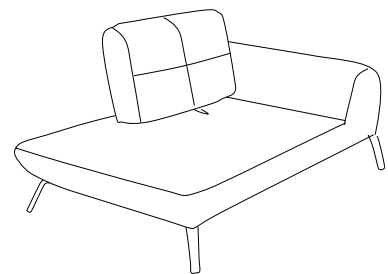
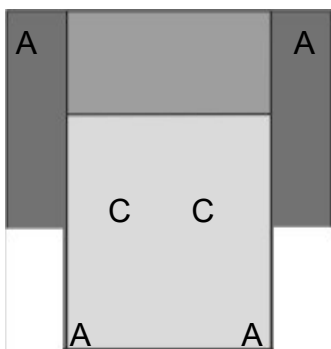
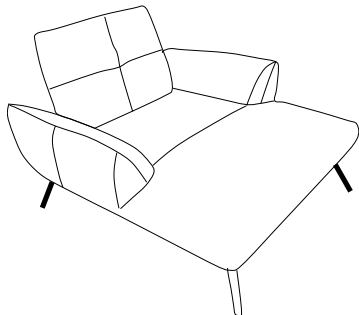

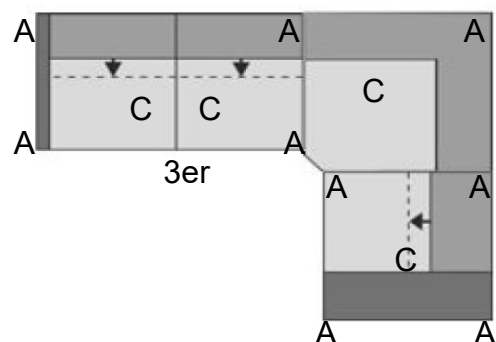
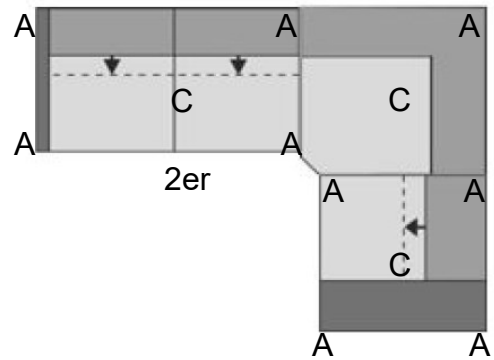
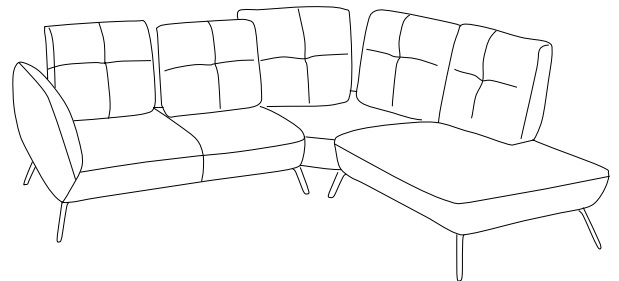
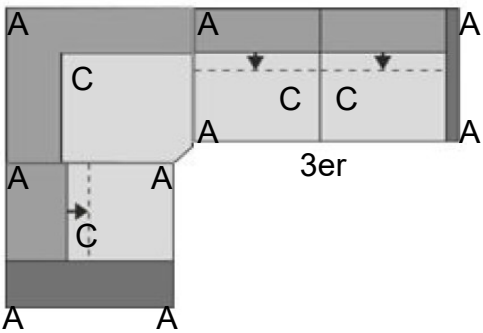
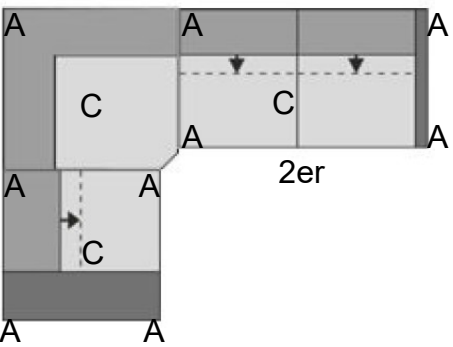
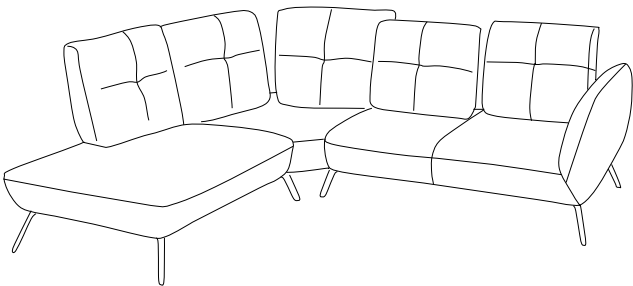
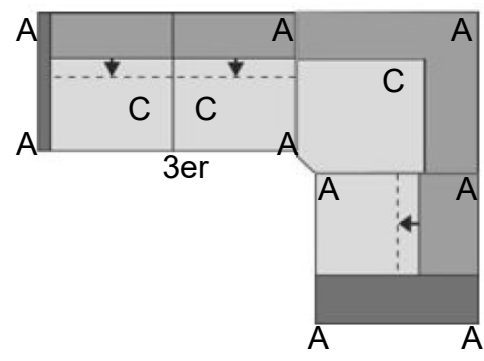
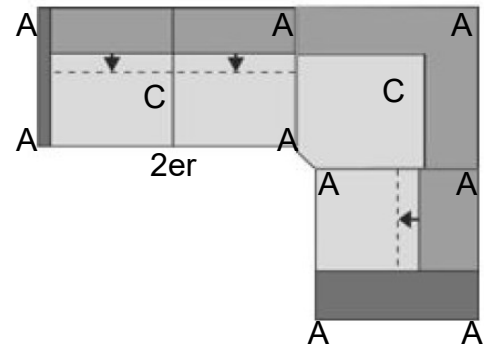
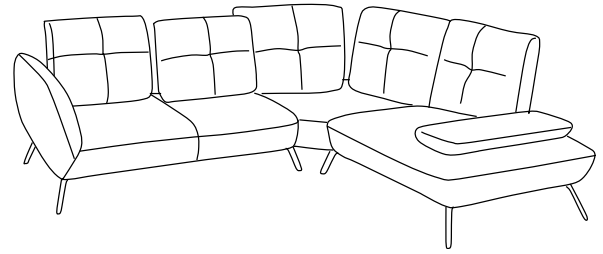
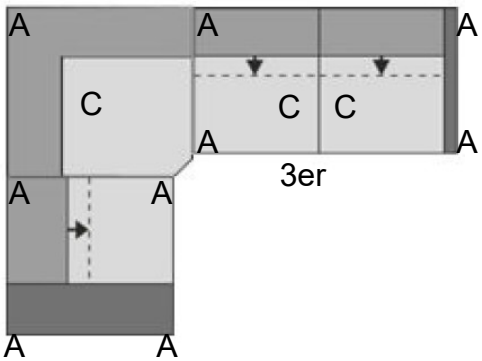
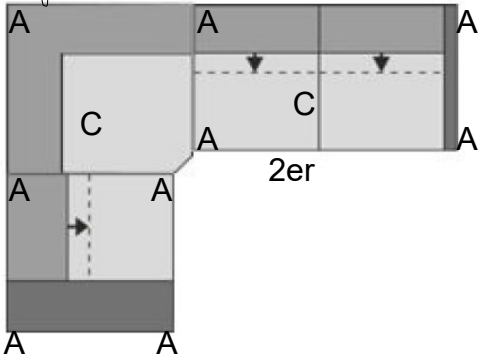
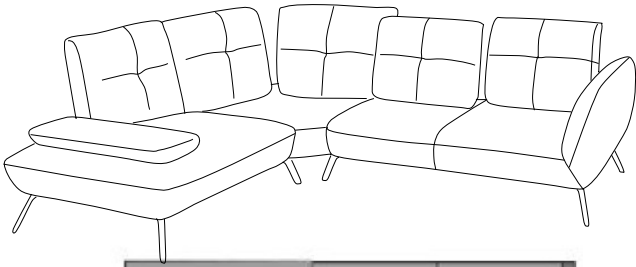

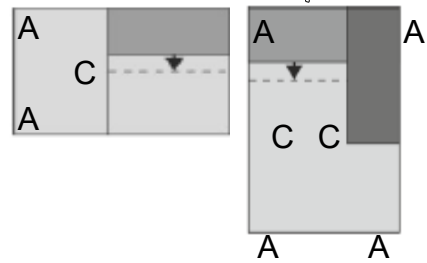
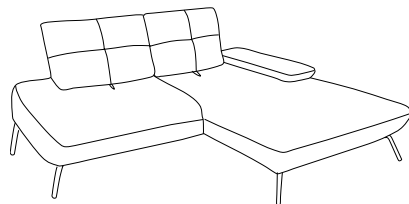
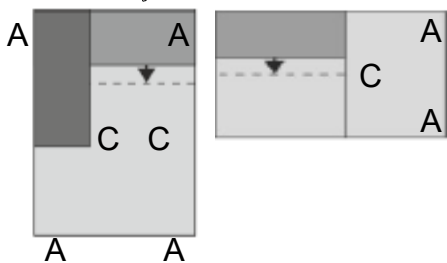
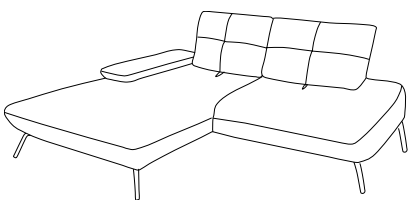
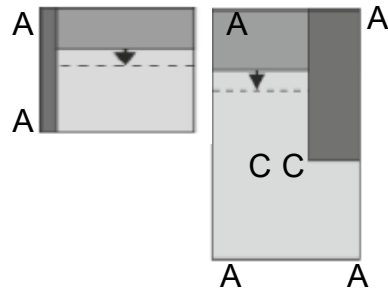
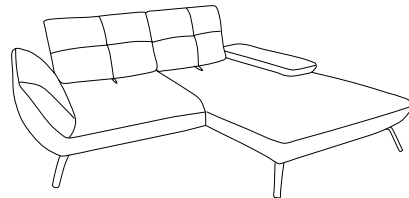
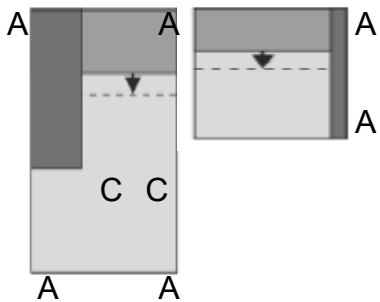
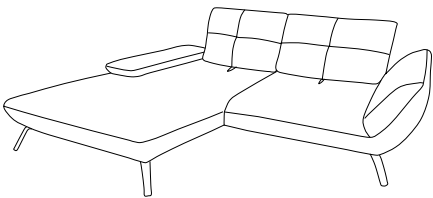
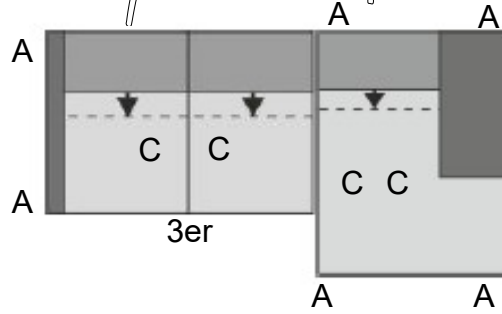
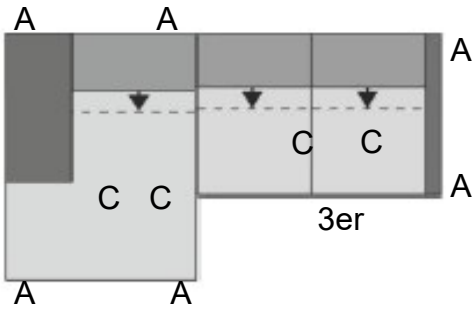
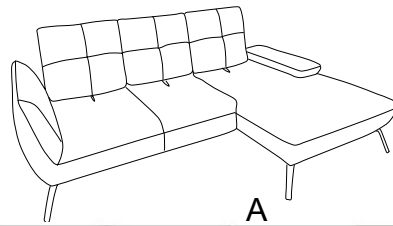
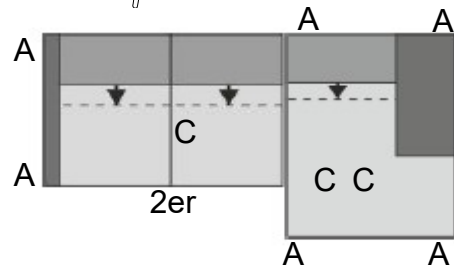
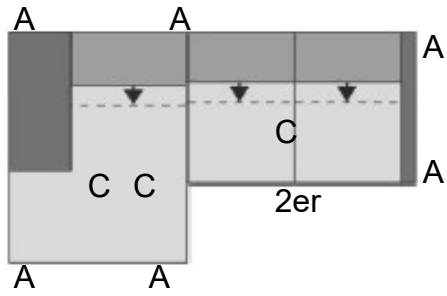
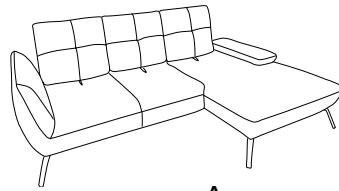



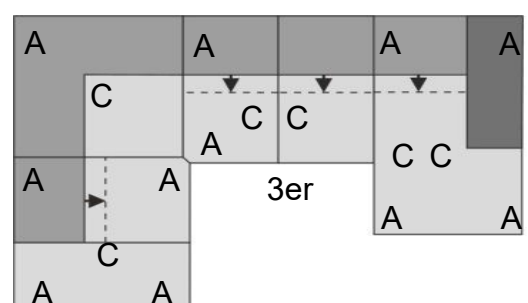
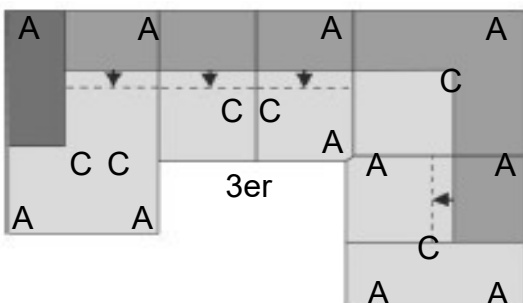
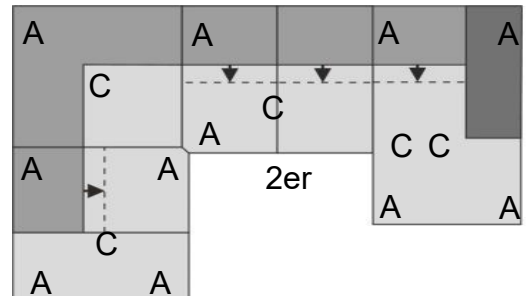
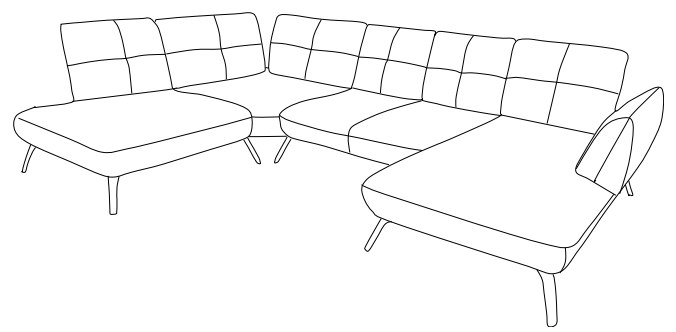
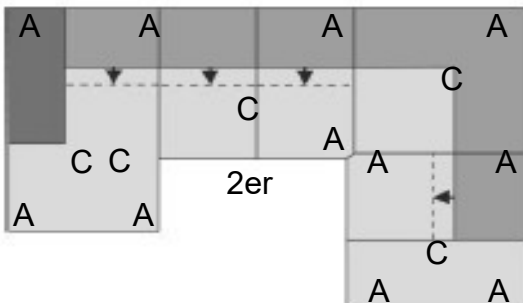
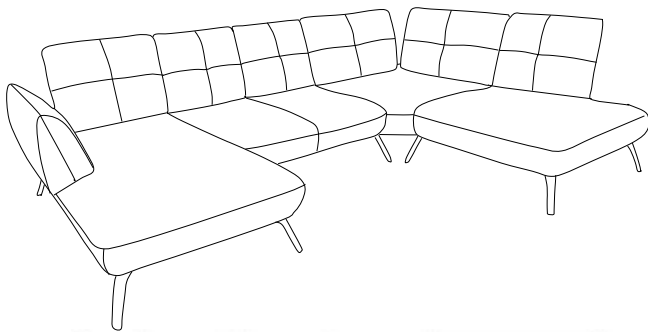
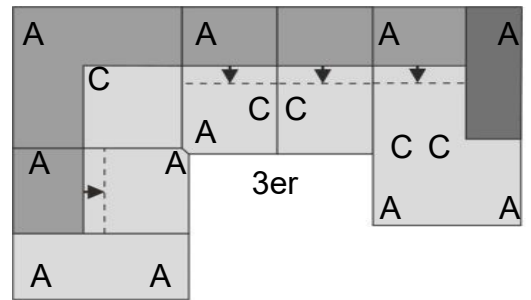
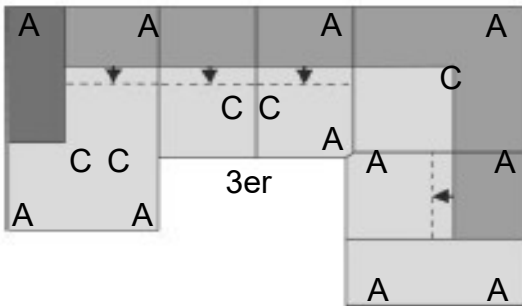
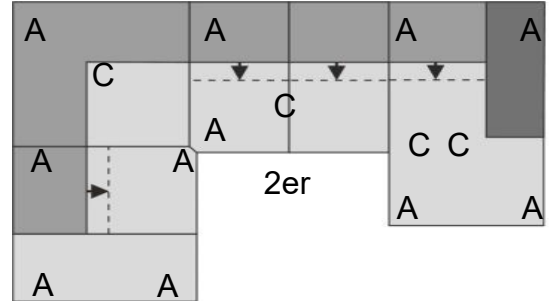
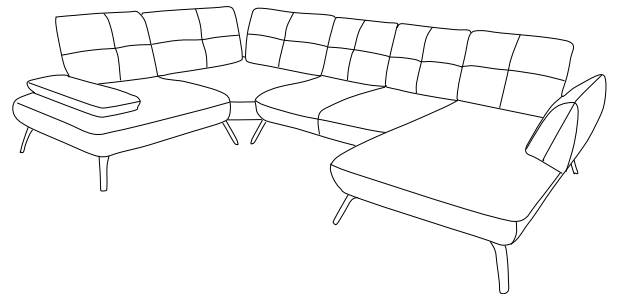
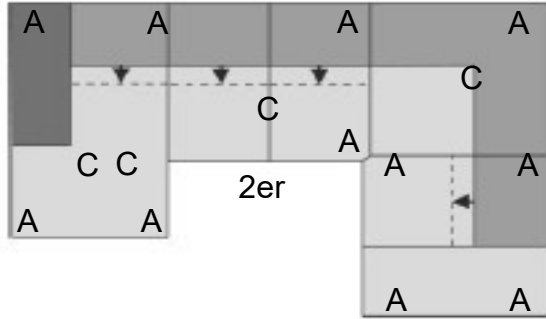
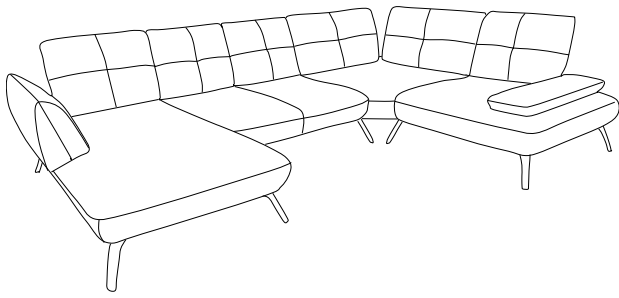

1

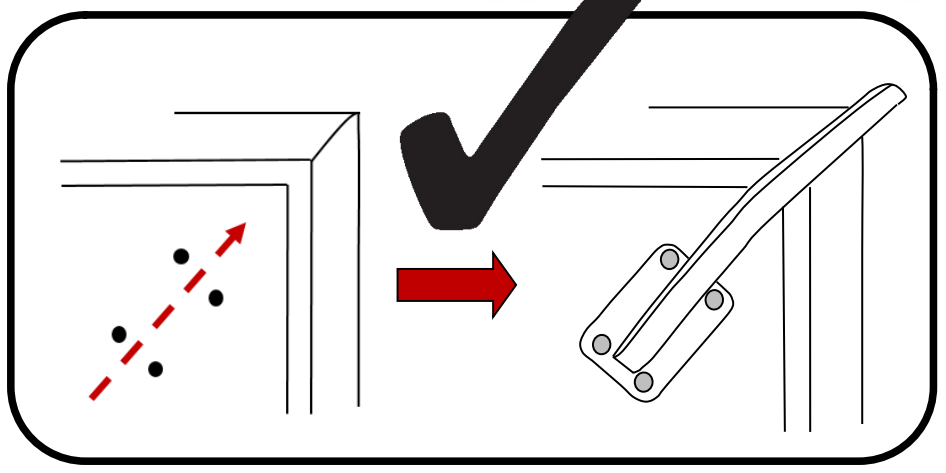
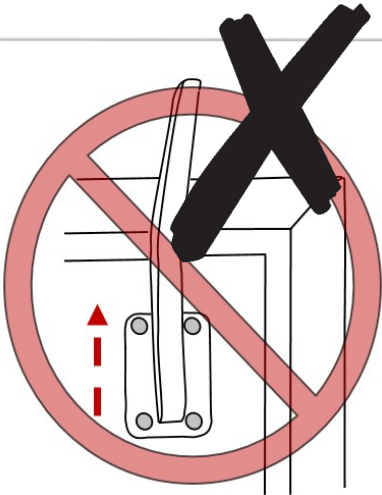
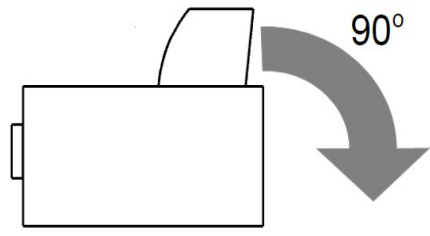

2

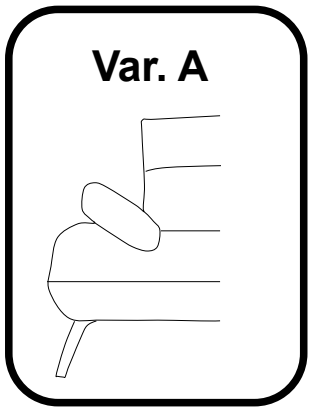

A

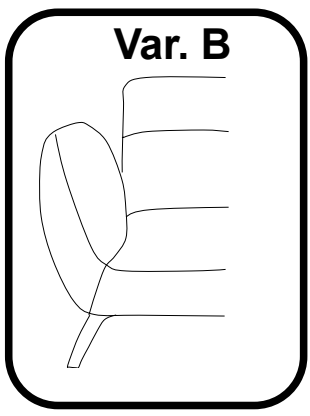
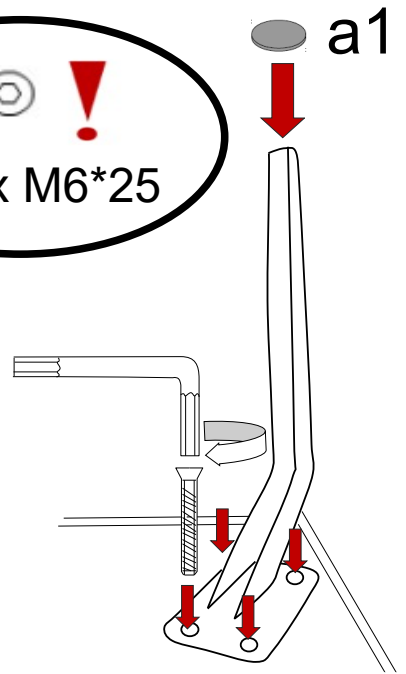
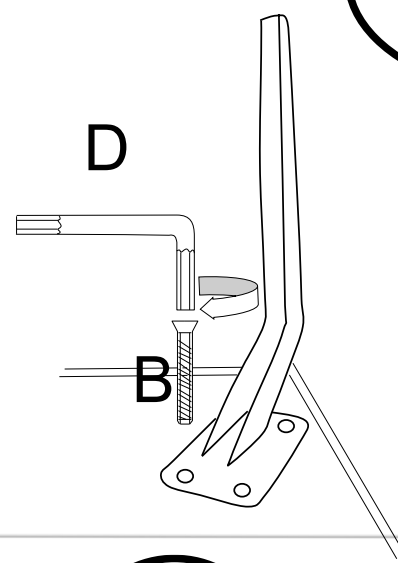
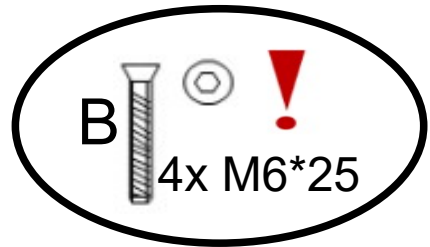

A

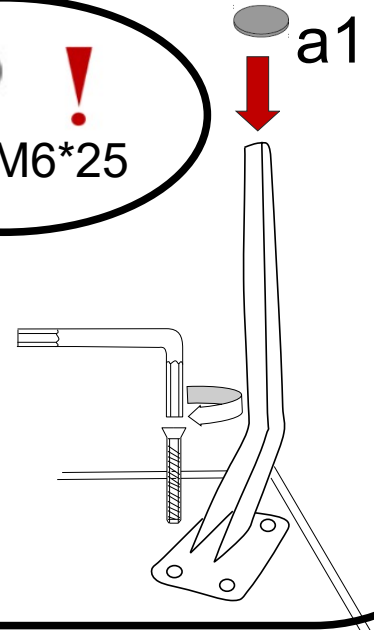
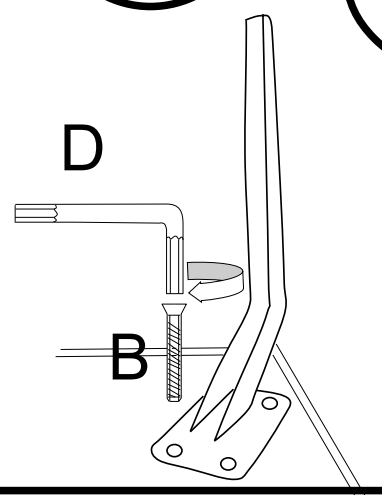
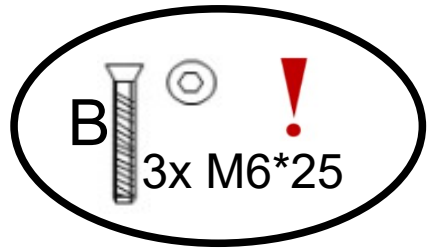

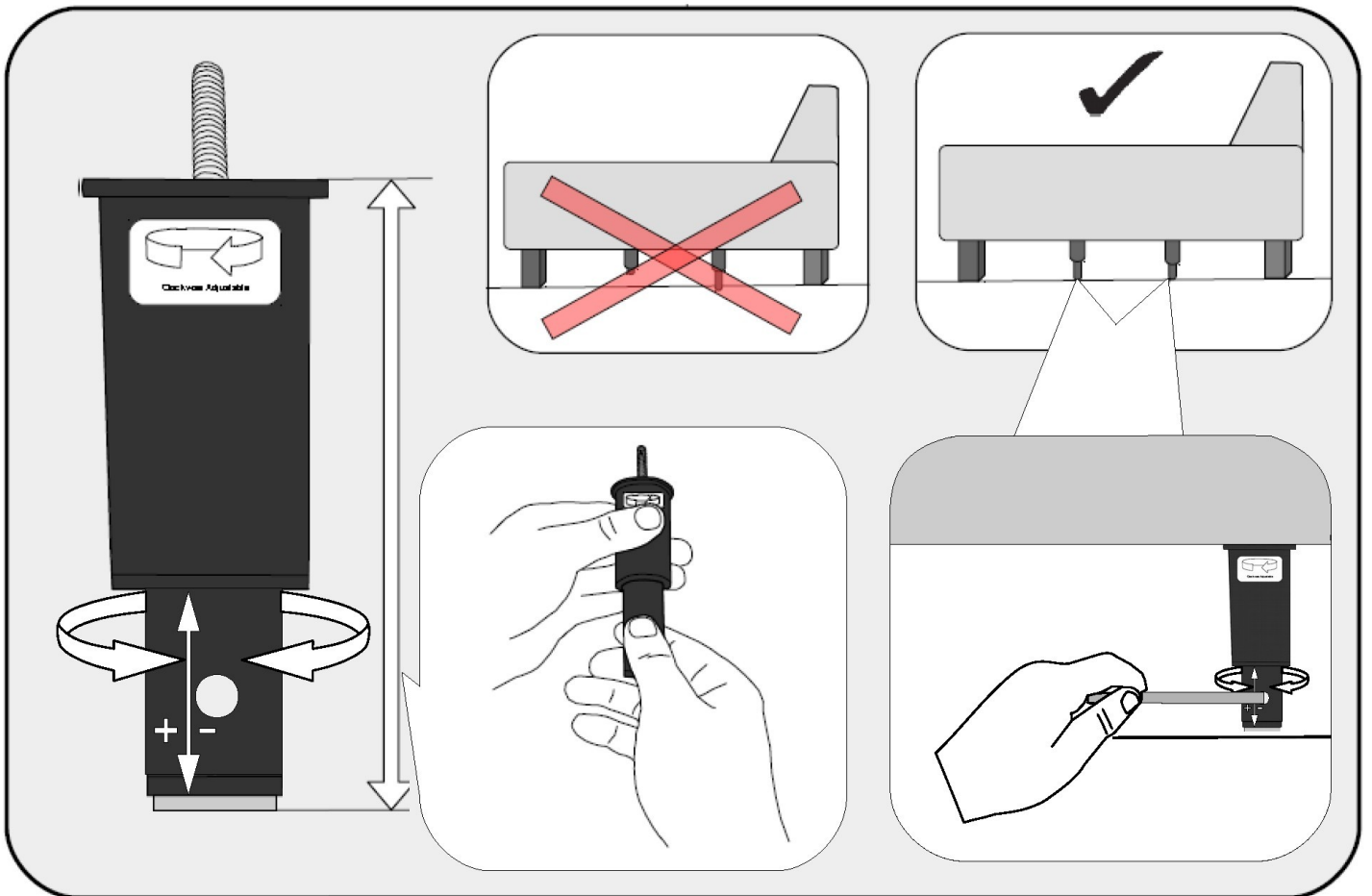
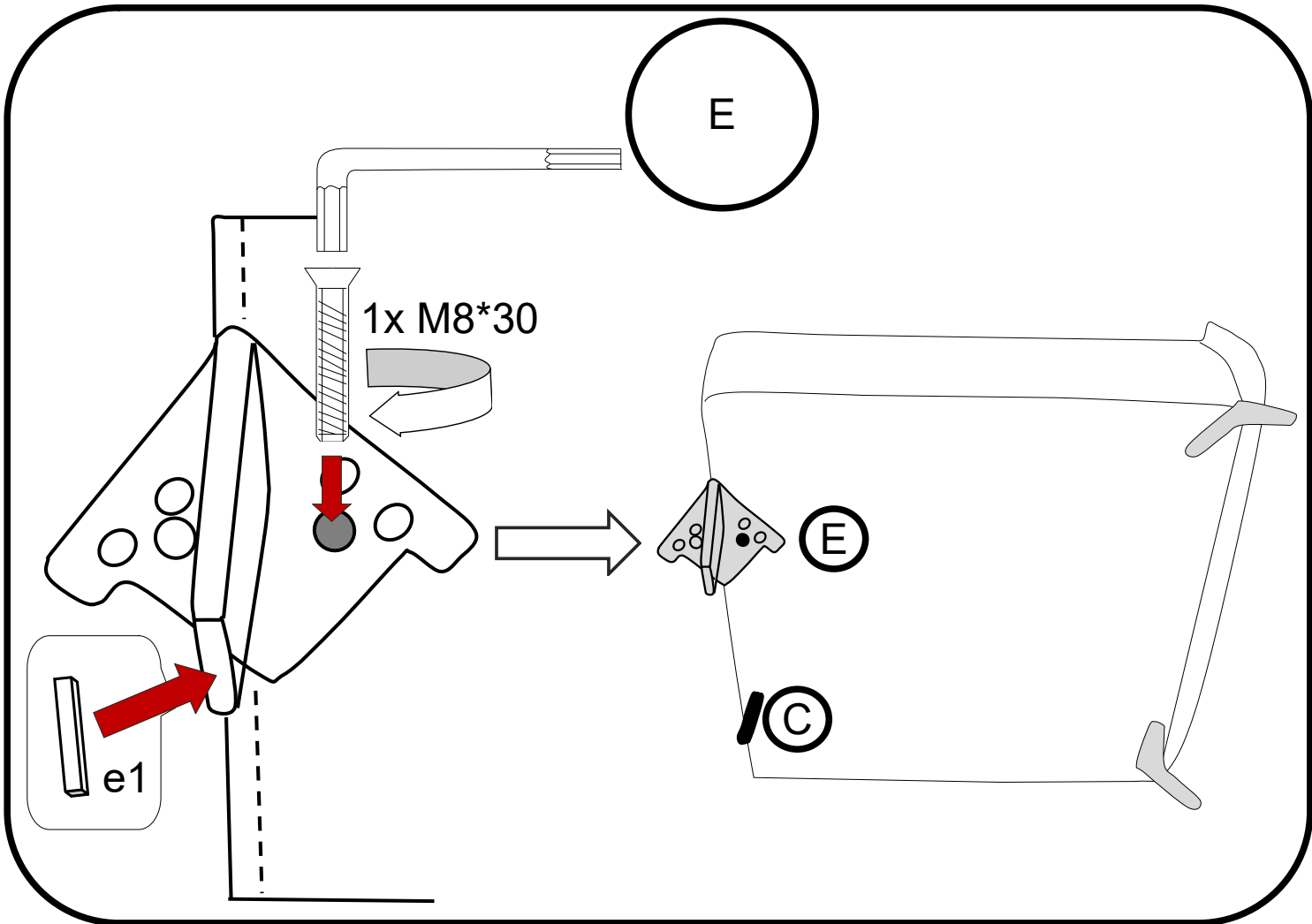

3

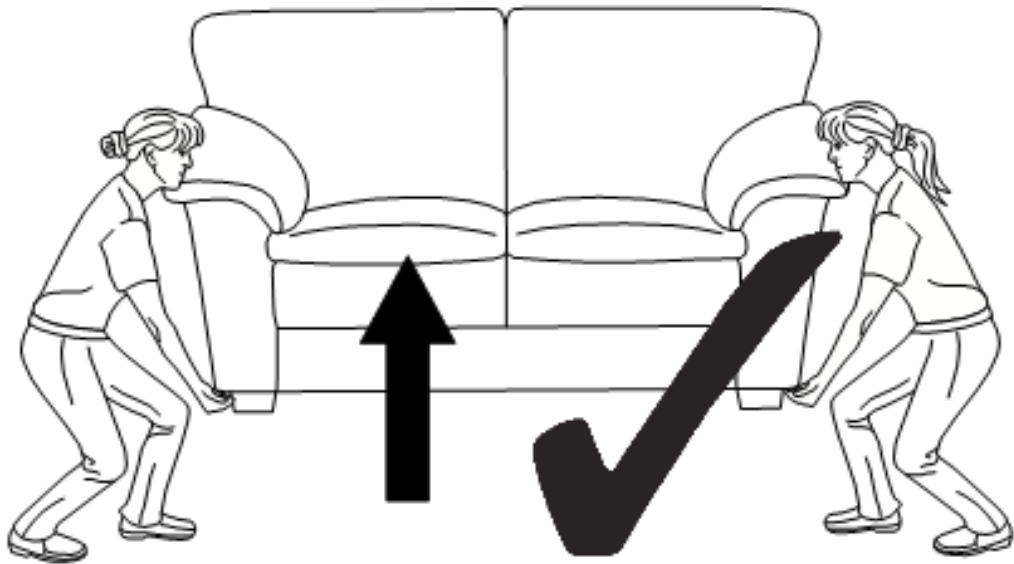
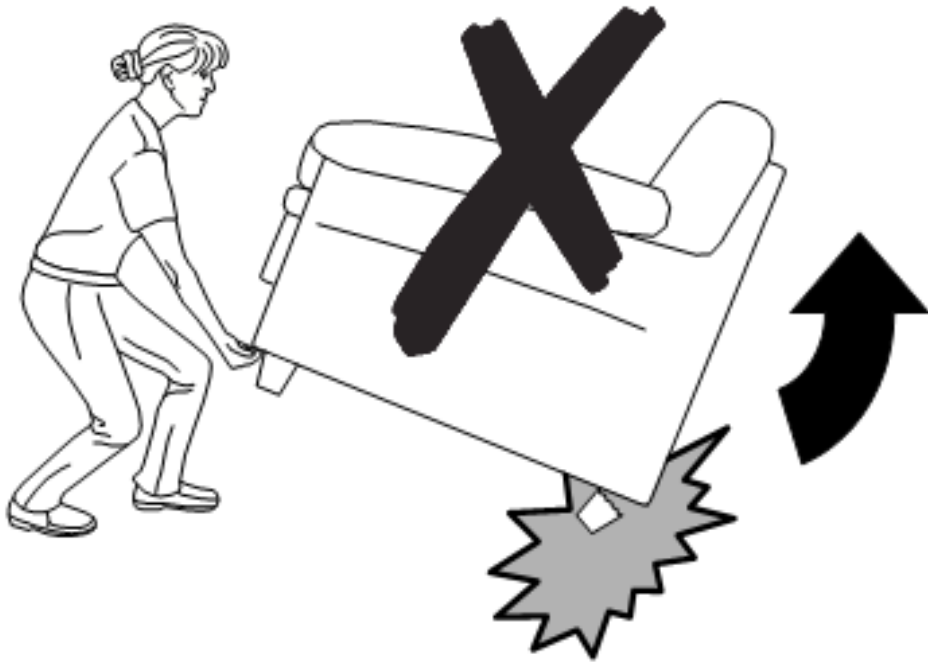
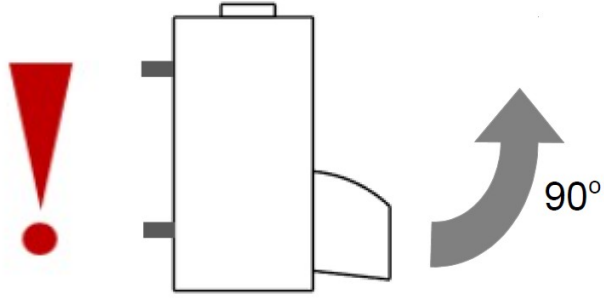

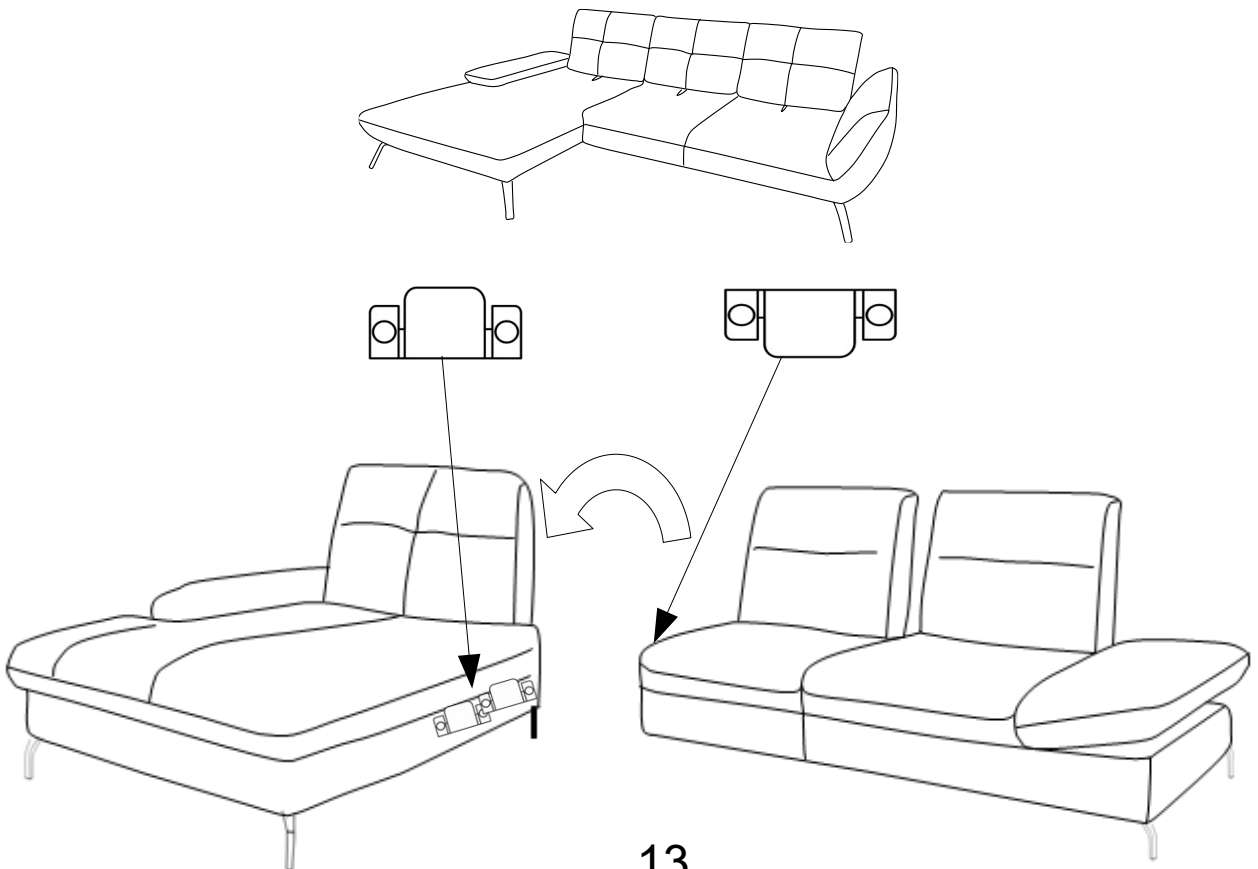
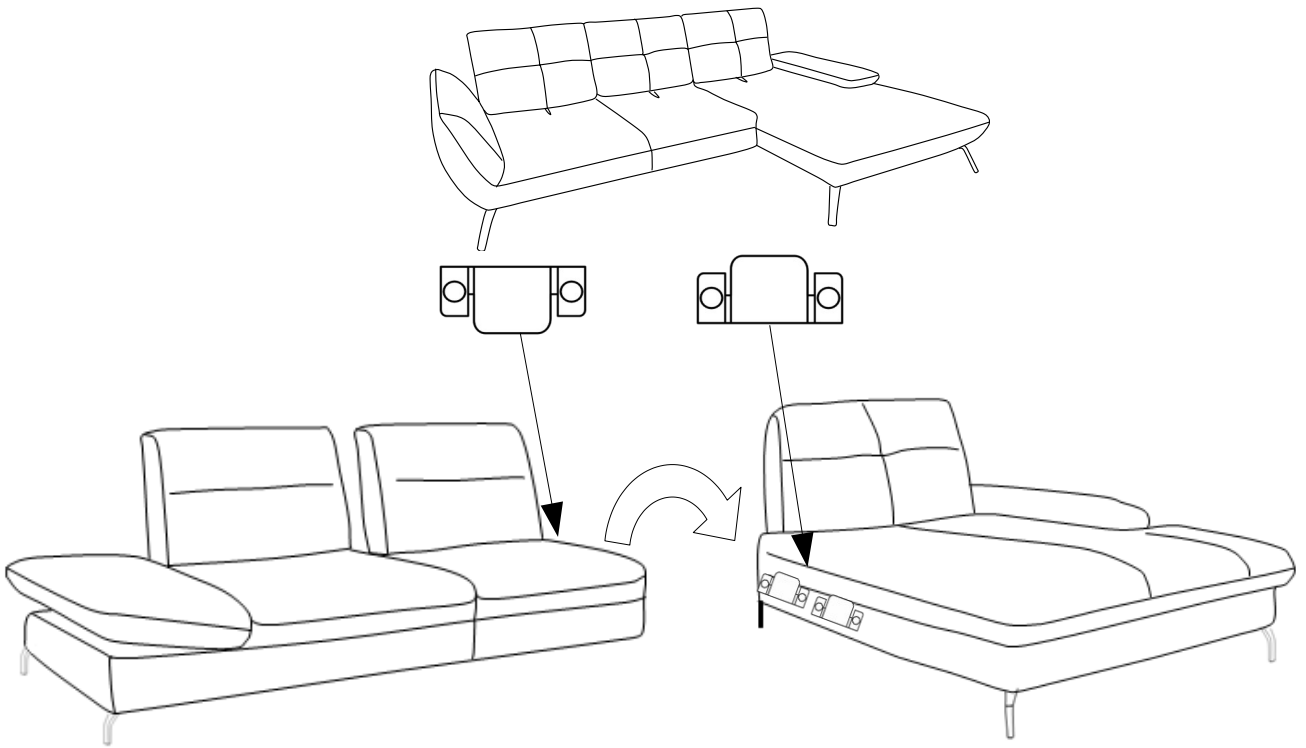

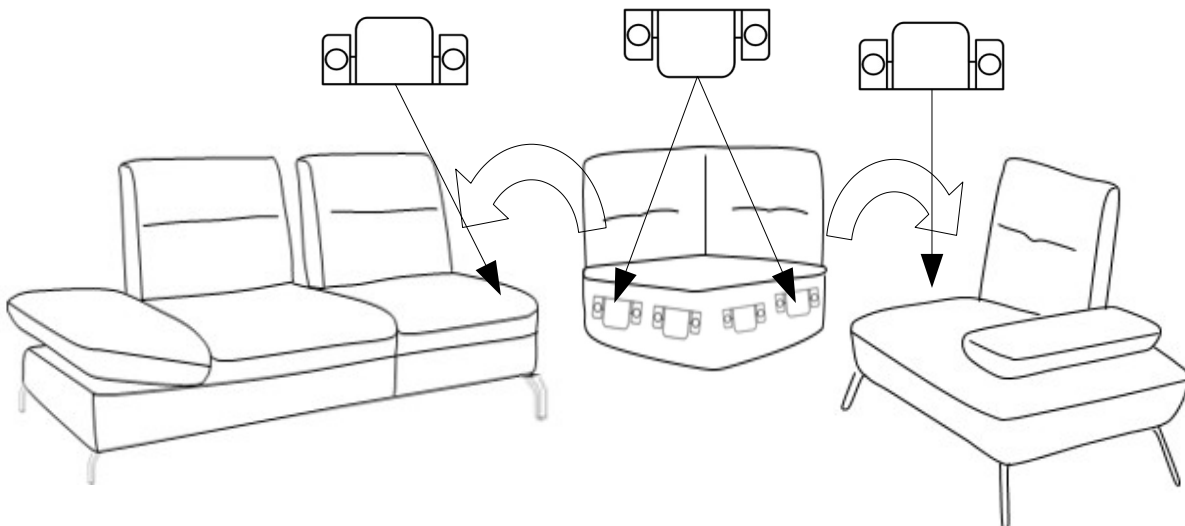
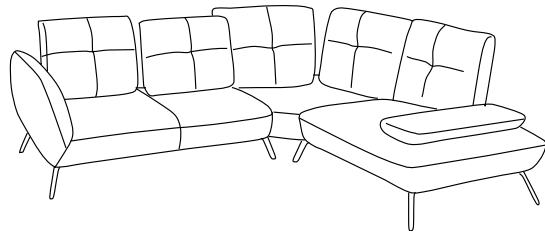
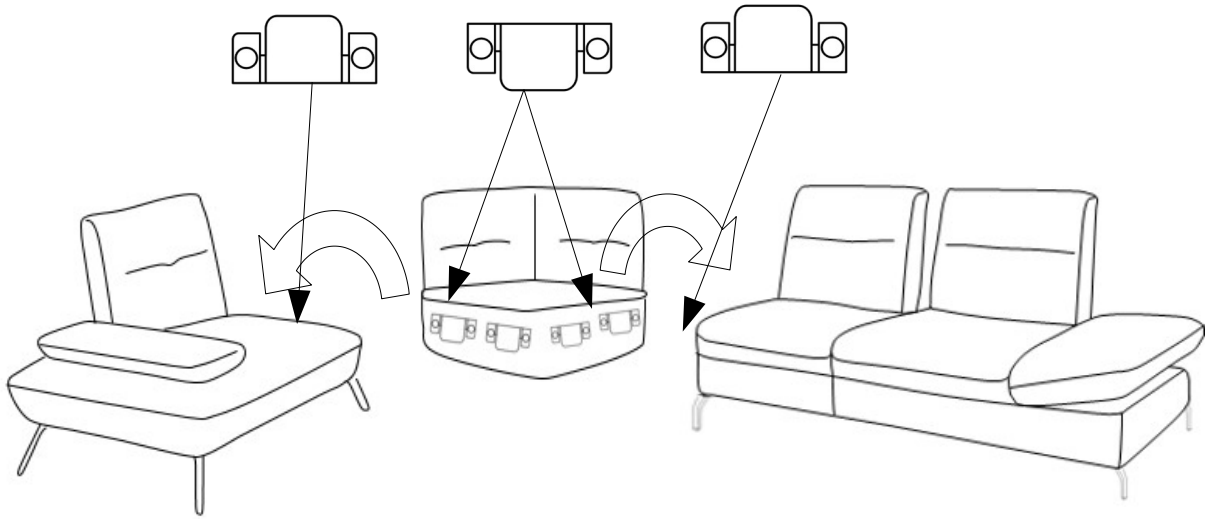
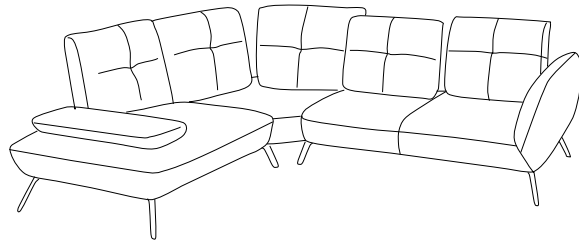

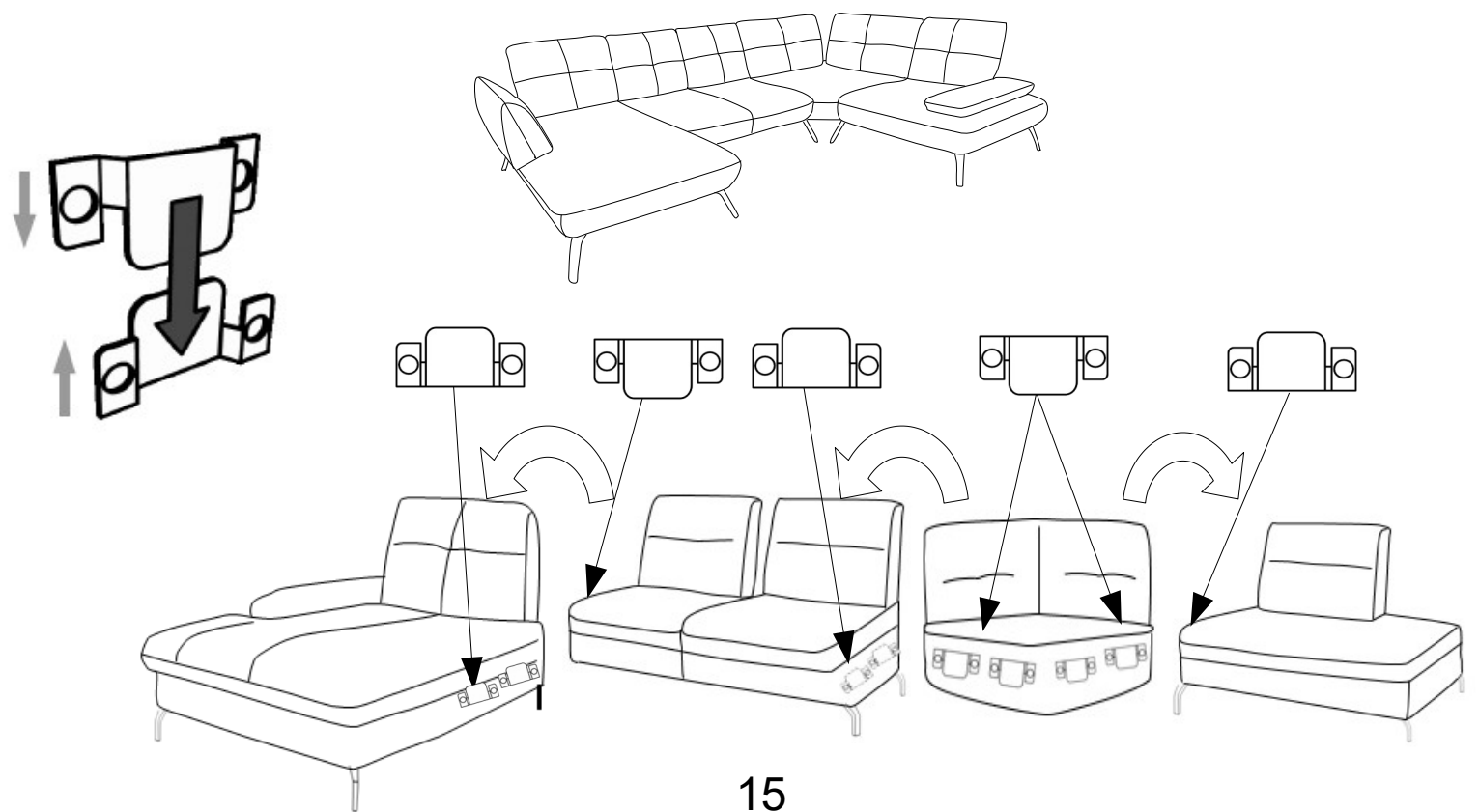
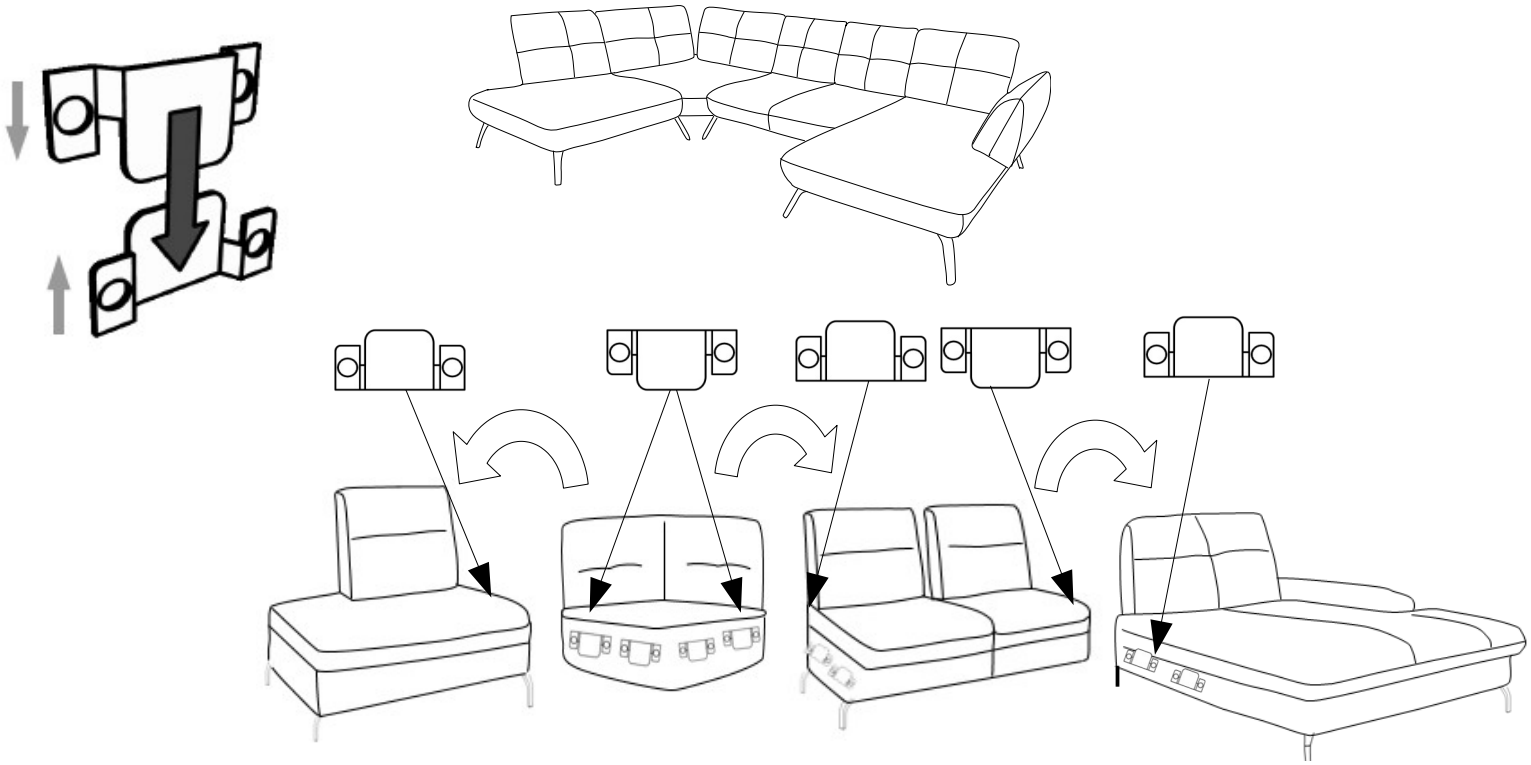

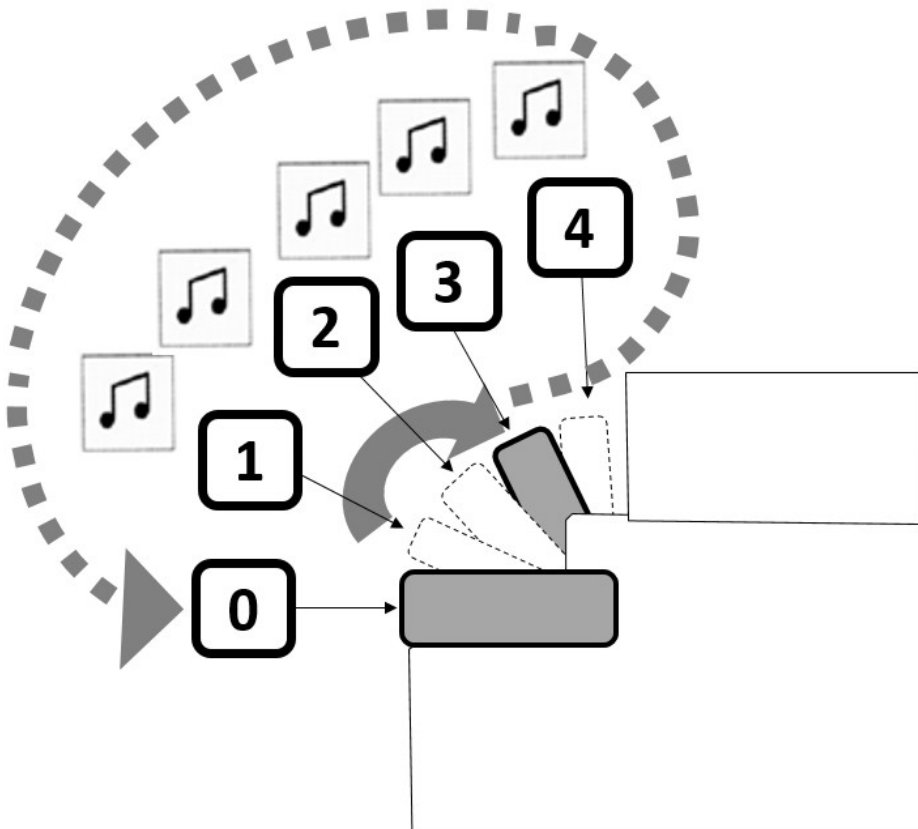
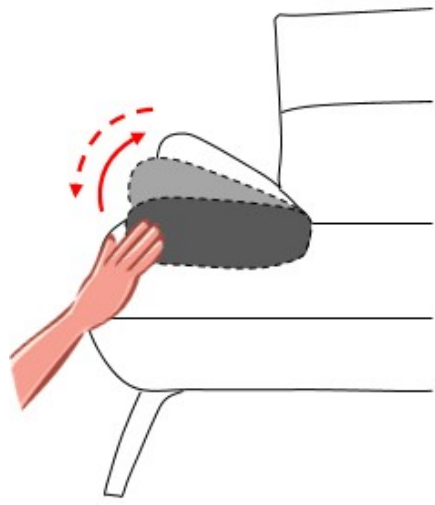
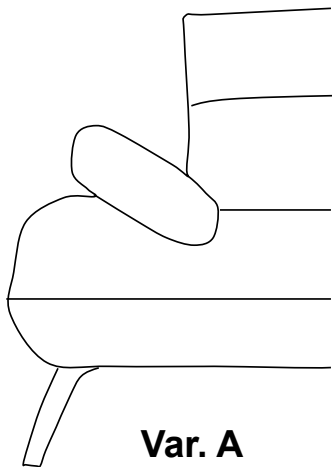
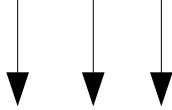
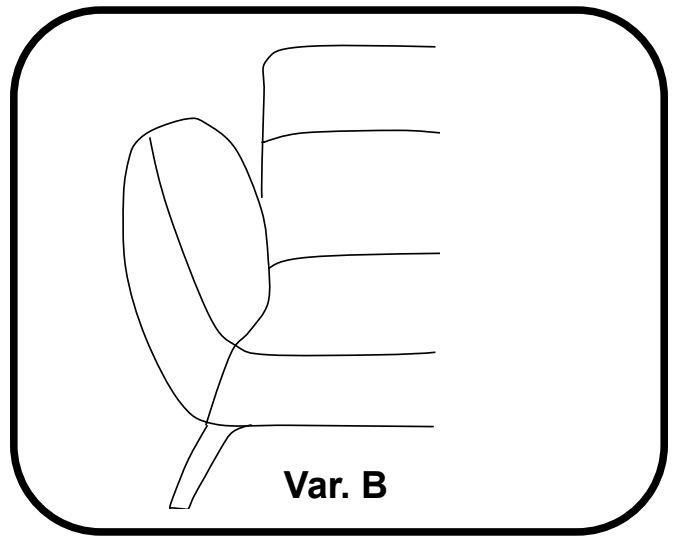
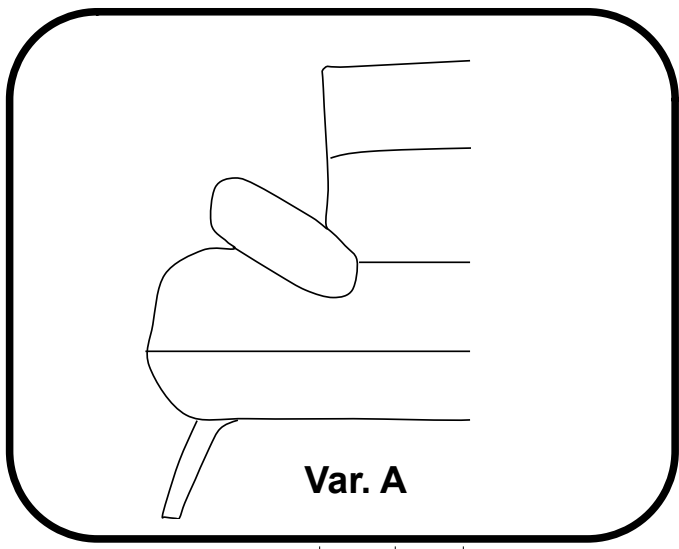





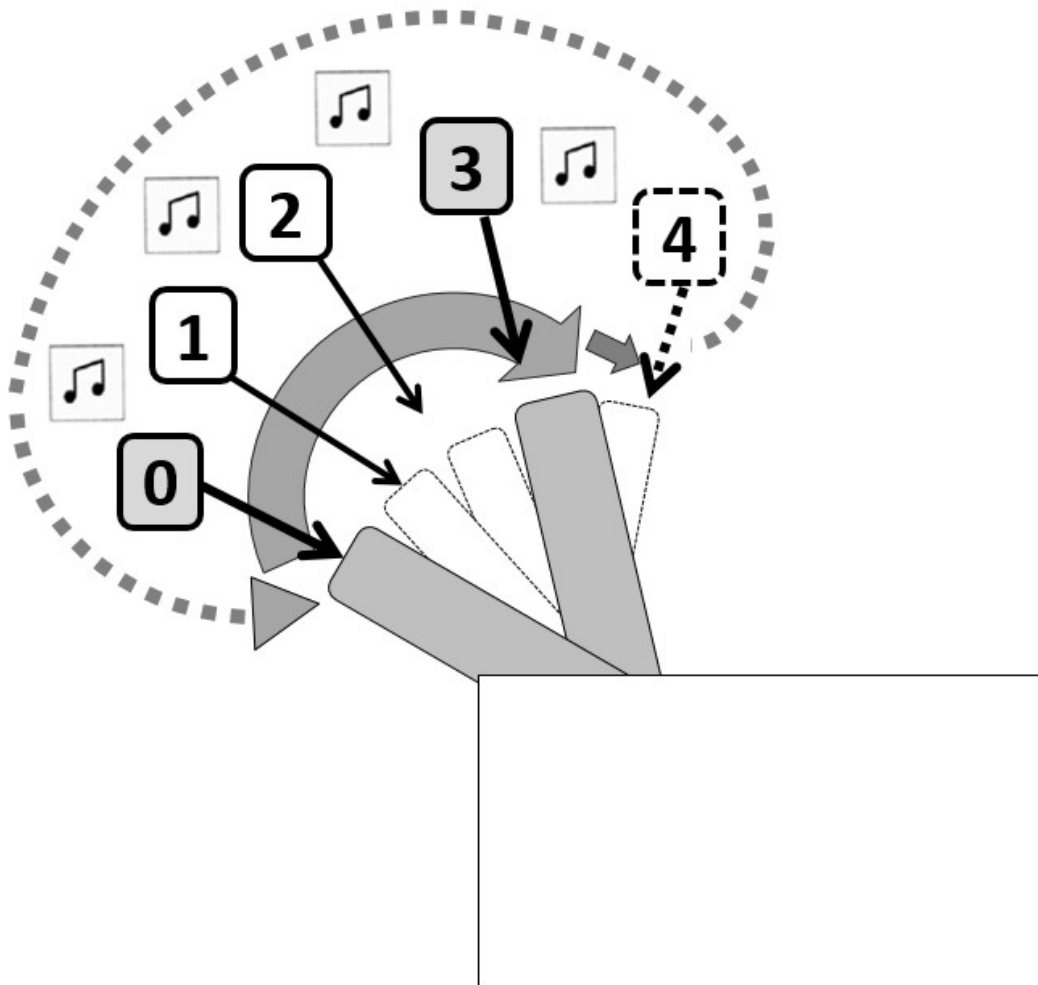
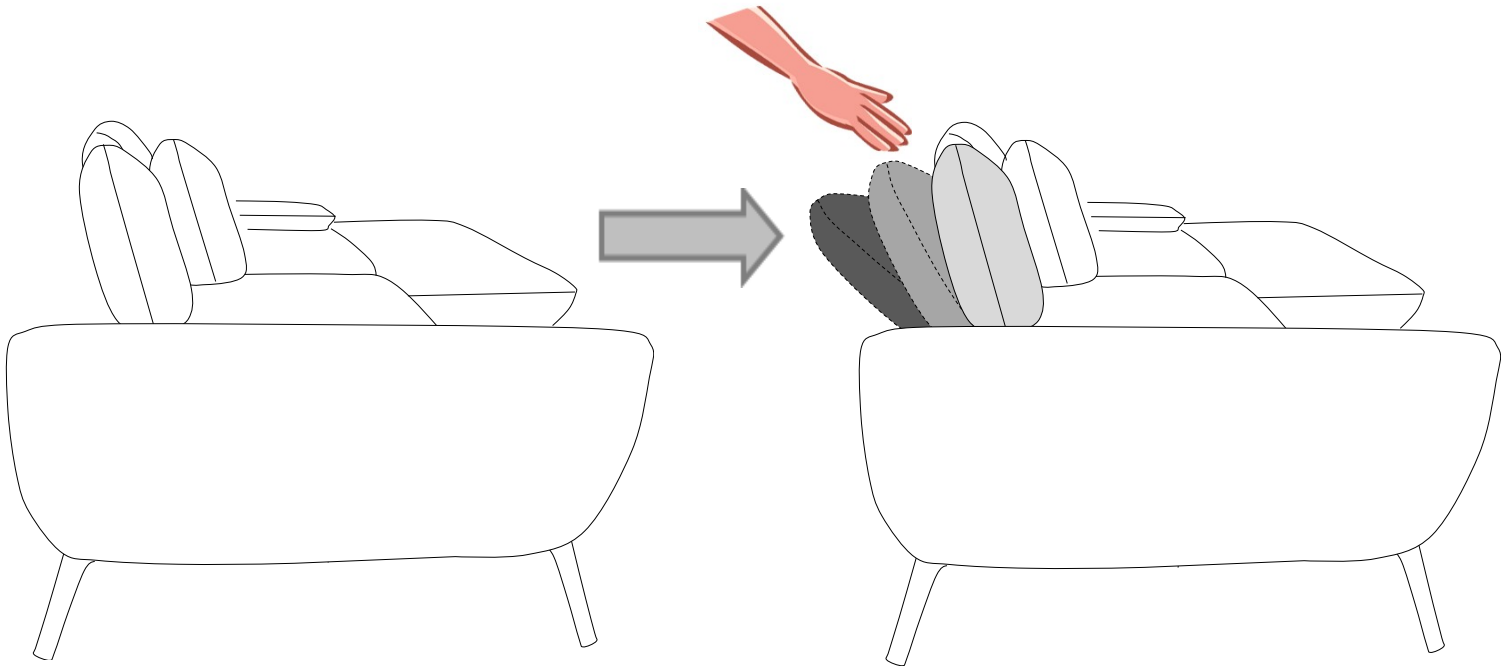

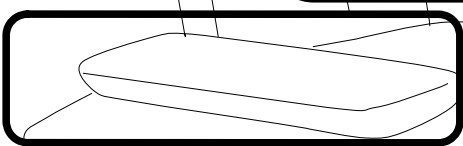
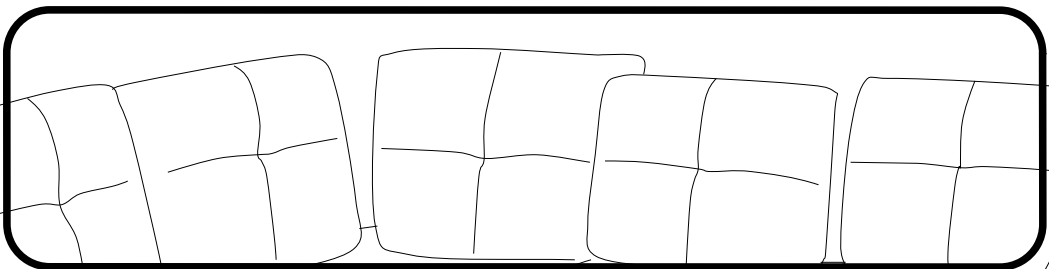
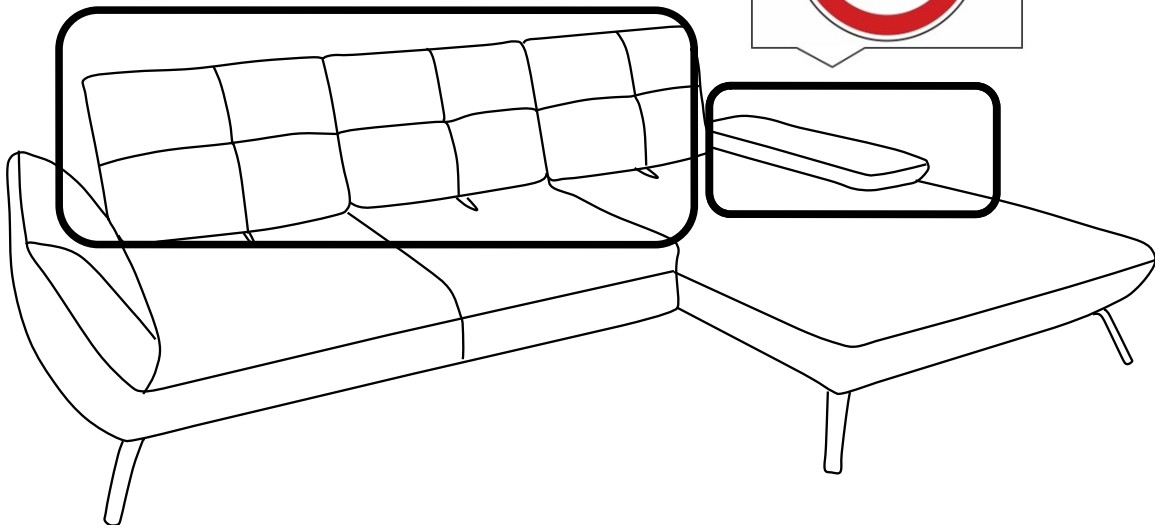
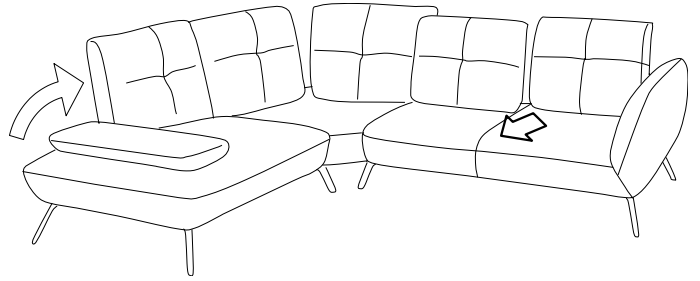
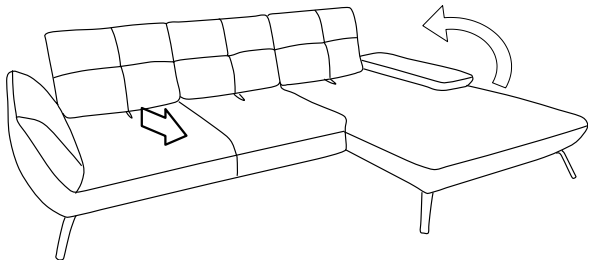

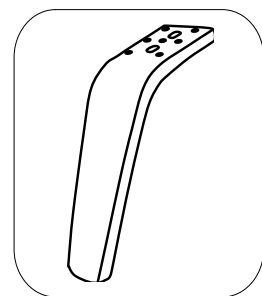
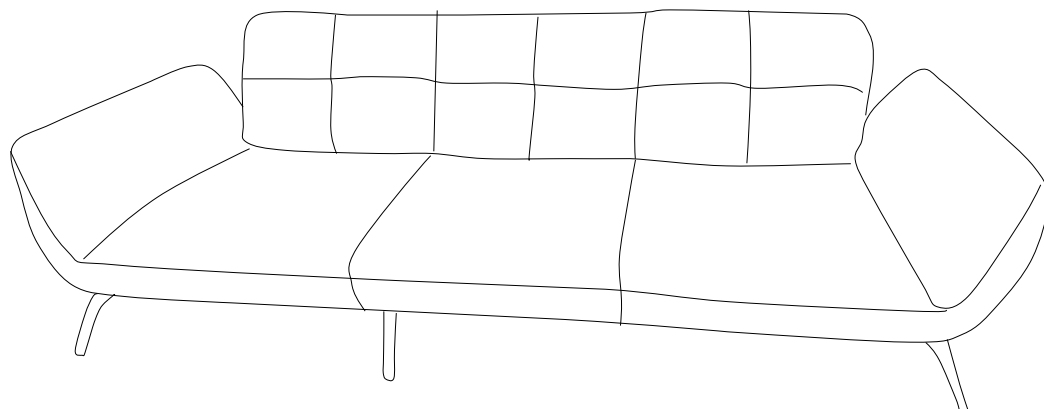
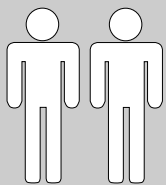

DOVER  
VITO TICONA  
TRENDY  
SEATTLE  
ALPHA  
BETA

V.03.- 07.09.2023

**D** MONTAGEANLEITUNG  
BEDIENUNGSANLEITUNG

**NL** HANDLEIDING VOOR DE MONTAGE  
GEBRUIKSAANWIJZING

**TR** MONTAJ TALIMATI  
KULLANIM KLAVUZU

**RO** INSTRUCȚIUNI DE INSTALARE  
INSTRUCȚIUNI DE UTILIZARE

**FR** NOTICE DE MONTAGE  
MANUEL INSTRUCTIONS

**HU** KÖZGYŰLÉS UTASÍTÁSOK  
KEZELÉSI UTASÍTÁS

**SI** NAVODILA ZA MONTAŽO  
NAVODILA ZA UPORABO

**ES** INSTRUCCIONES DE MONTAJE  
MANUAL DEL USUARIO

**GB** ASSEMBLY INSTRUCTIONS  
INSTRUCTION MANUAL

**PL** INSTRUKCJA MONTAŻU  
INSTRUKCJA OBSŁUGI

**RU** ИНСТРУКЦИЯ ПО МОНТАЖУ  
ИНСТРУКЦИЯ ПО ЭКСПЛУАТАЦИИ

**IT** ISTRUZIONI DI MONTAGGIO  
MANUALE DI ISTRUZIONI

**SK** MONTÁŽNY NÁVOD  
NÁVOD NA POUŽITIE

**CZ** MONTÁŽNÍ NÁVOD  
NÁVOD K POUŽITÍ

**PT** INSTRUÇÕES DE MONTAGEM  
MANUAL DO USUÁRIO

**HR** UPUTE ZA MONTAŽU  
UPUTE ZA UPOTREBU







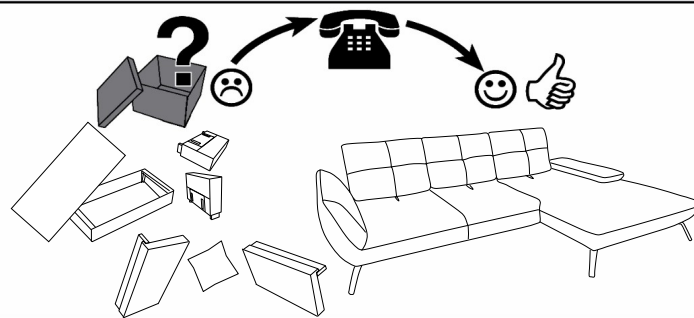
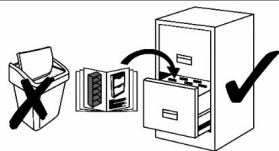

Service · Dienstverlening · Serwis · Servis · Сервисная служба · Serviciu ·  
Services · Servizio · Servisný list · Szolgáltatás · Servisní list

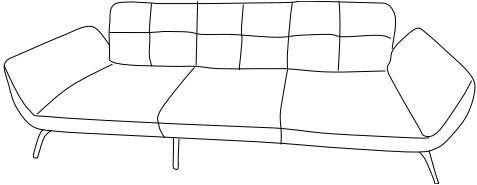
Name · Naam · Nazwa · İsim · Название · Nume · Nome ·  
Názov · Názoв · Název · Neve

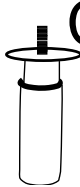
DOVER / VITO TICONA / TRENDY / SEATTLE / ALPHA

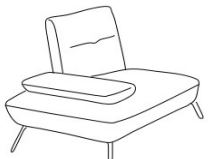
Тип · Type · Tip · Тип · Tipo · Típus

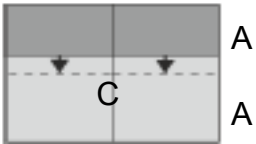
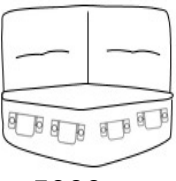
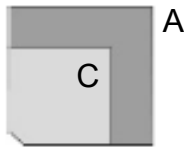

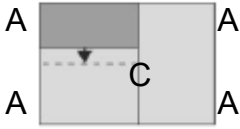
✓			 A = a1	 B M6x25	 C	 D L4
	 1100-1300		4 x A 4 x a1	2 x 4B 2 x 2B	/	
	 2000		2 x A 2 x a1	8x	1x	1x
	 5000		1 x A 1 x a1	4x	1x	
	 1051-1053		4 x A 4 x a1	16x	1x	

## Zusatzinformation für die Fußmontage

### **ACHTUNG!**

Bitte beachten Sie, dass bei dieser Zusammenstellung  
die Füße aussen schräg  
und die mittleren Füße zwischen 1er links und dem 2er gerade  
und mit 2 Schrauben montiert werden sollen.

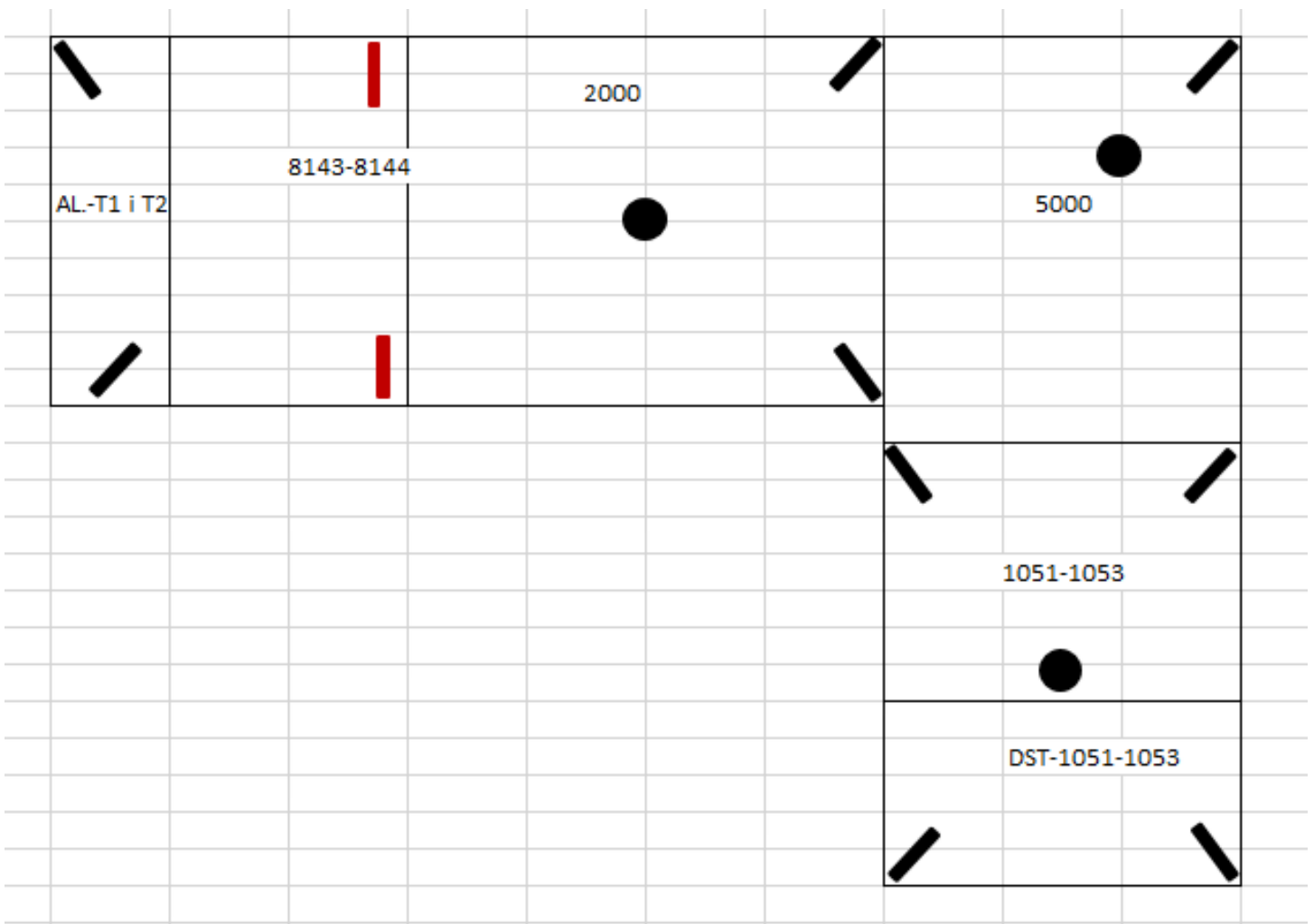

# ACHTUNG!

Bitte beachten Sie, dass bei dieser Zusammenstellung die FüÙe aussen schräg und die mittleren FüÙe zwischen 1er links und dem 2er gerade und mit 2 Schrauben montiert werden sollen.

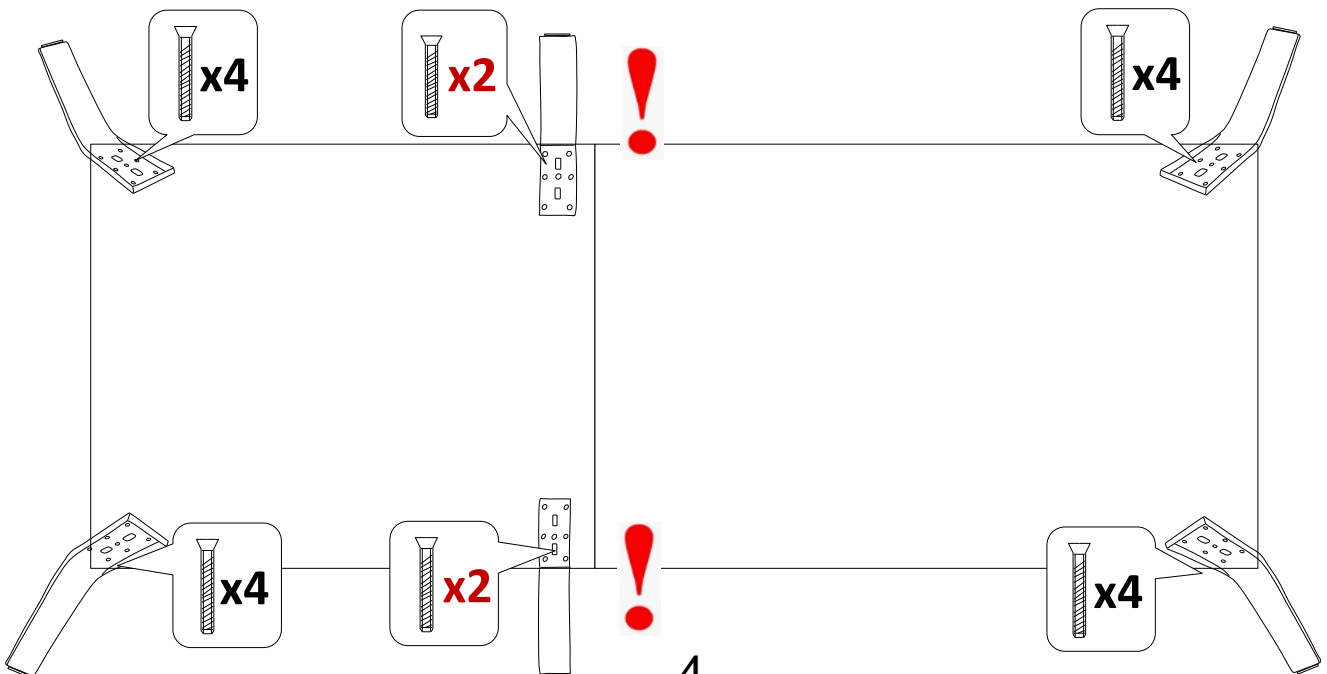
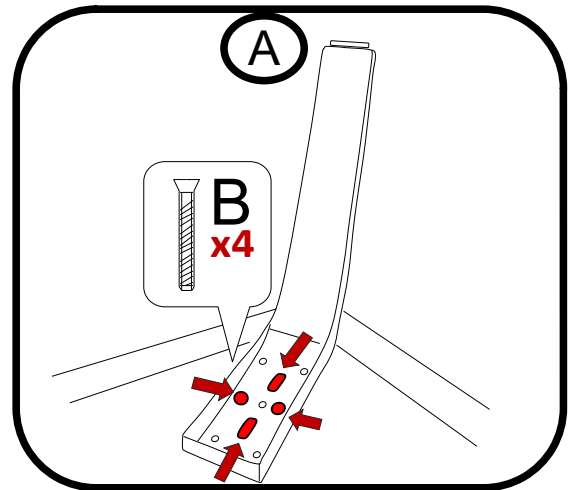
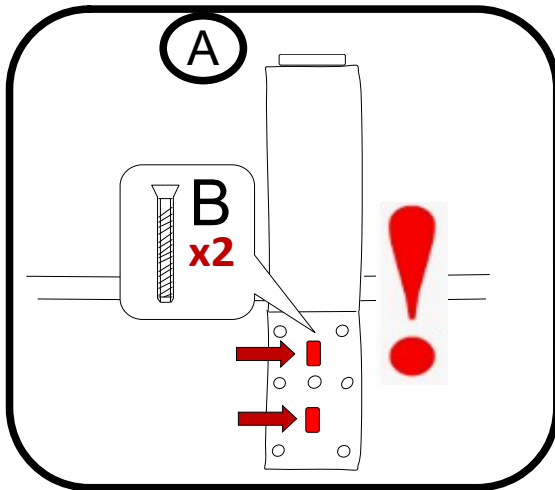
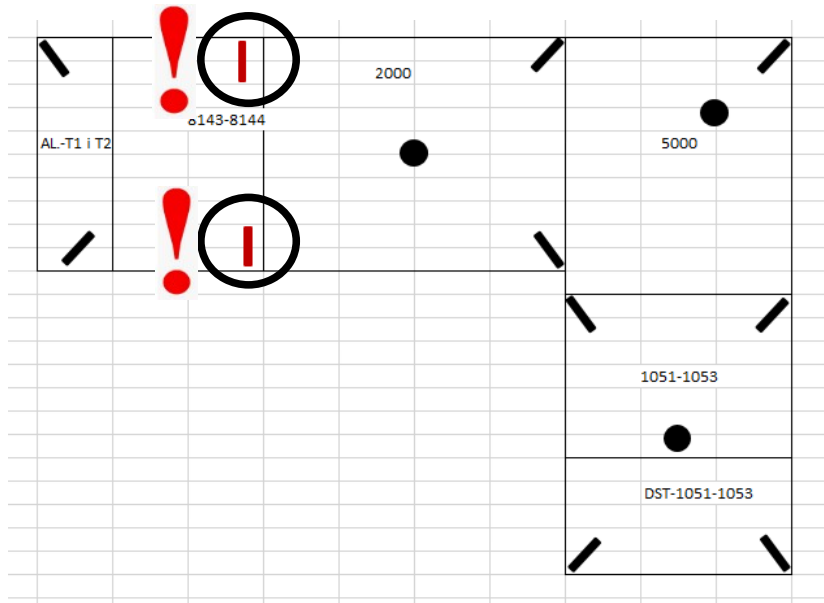

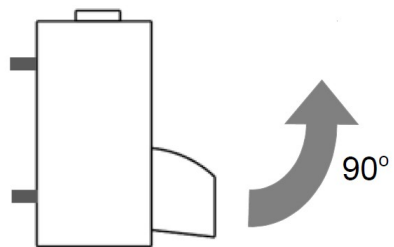
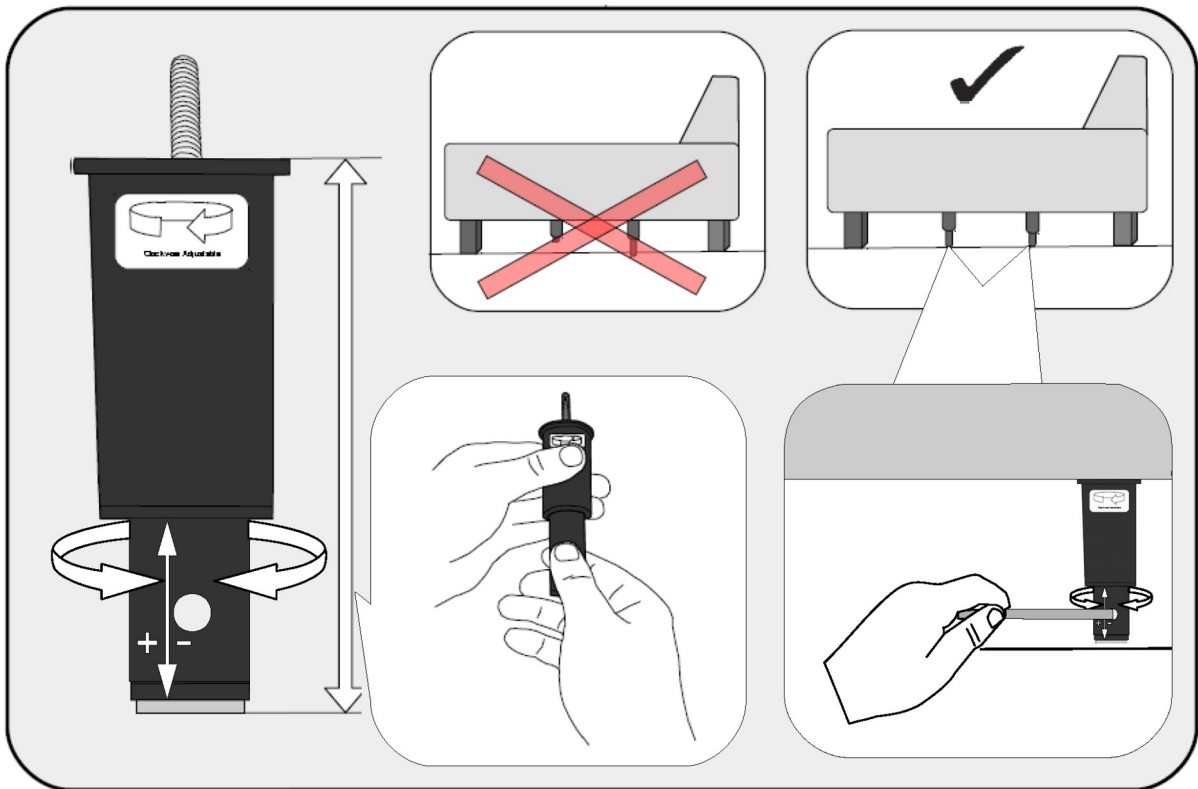
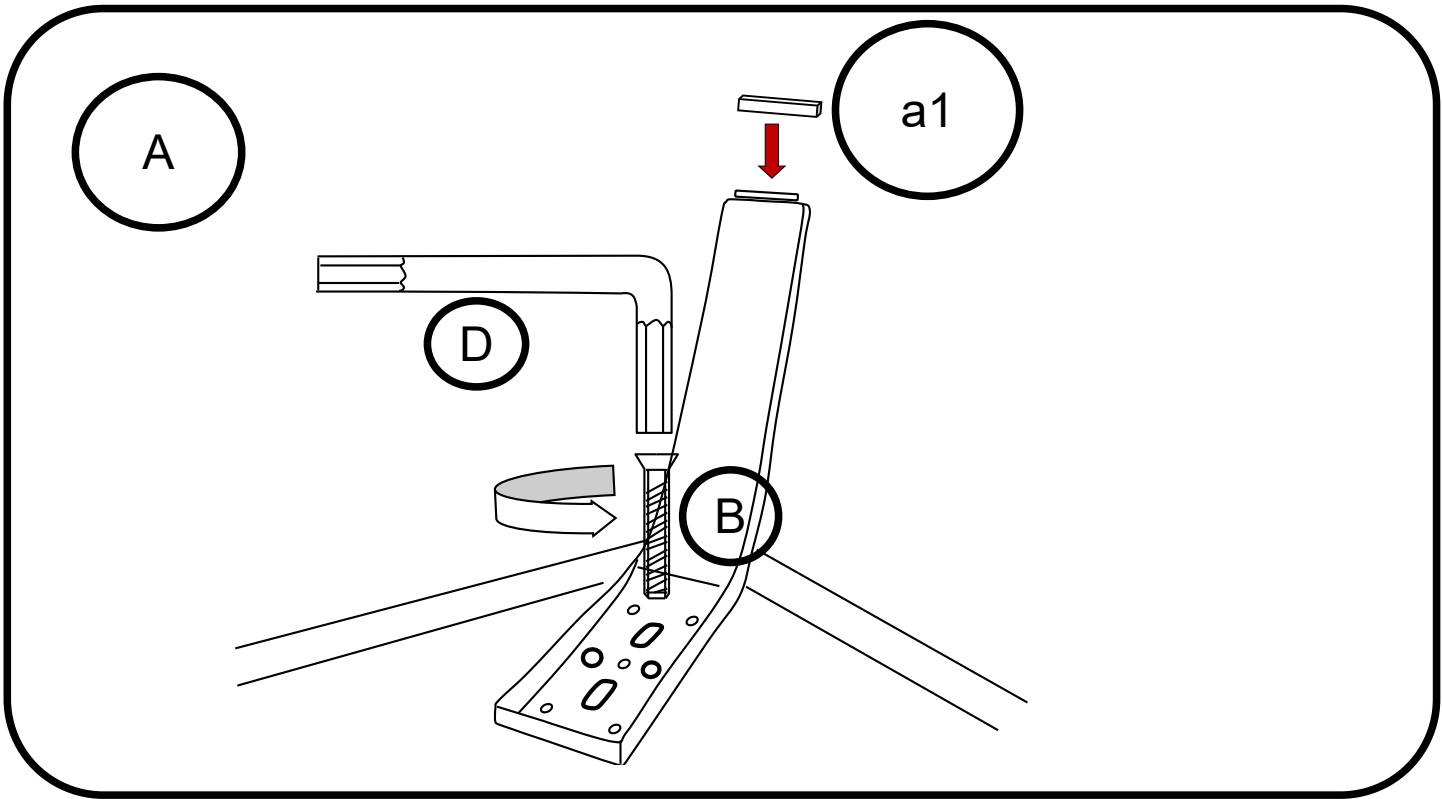
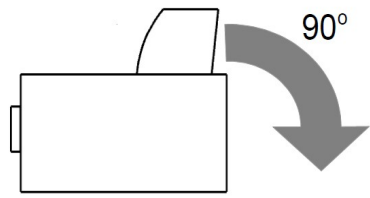



1

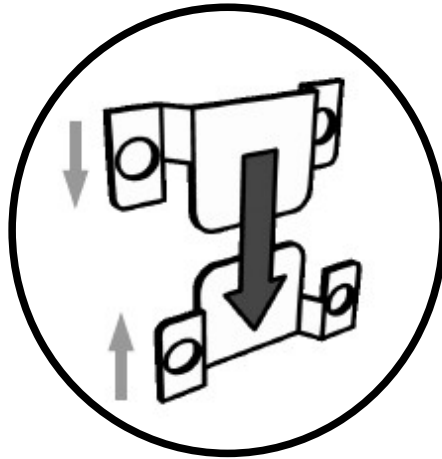
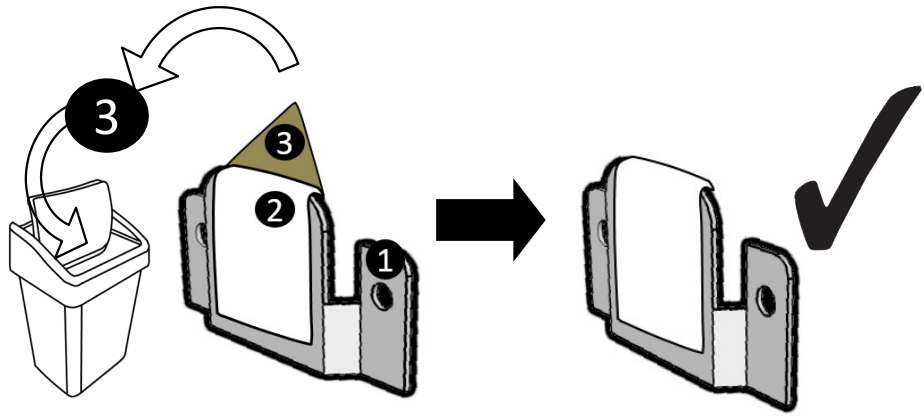

2

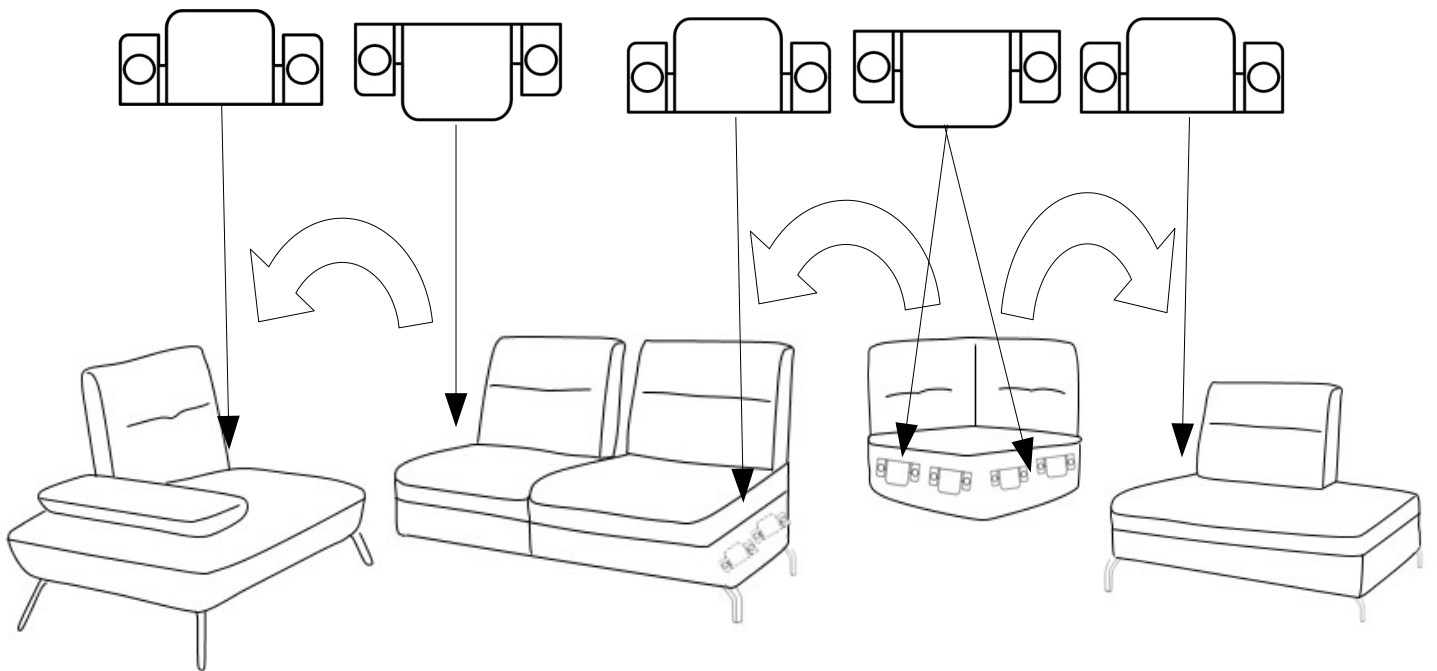

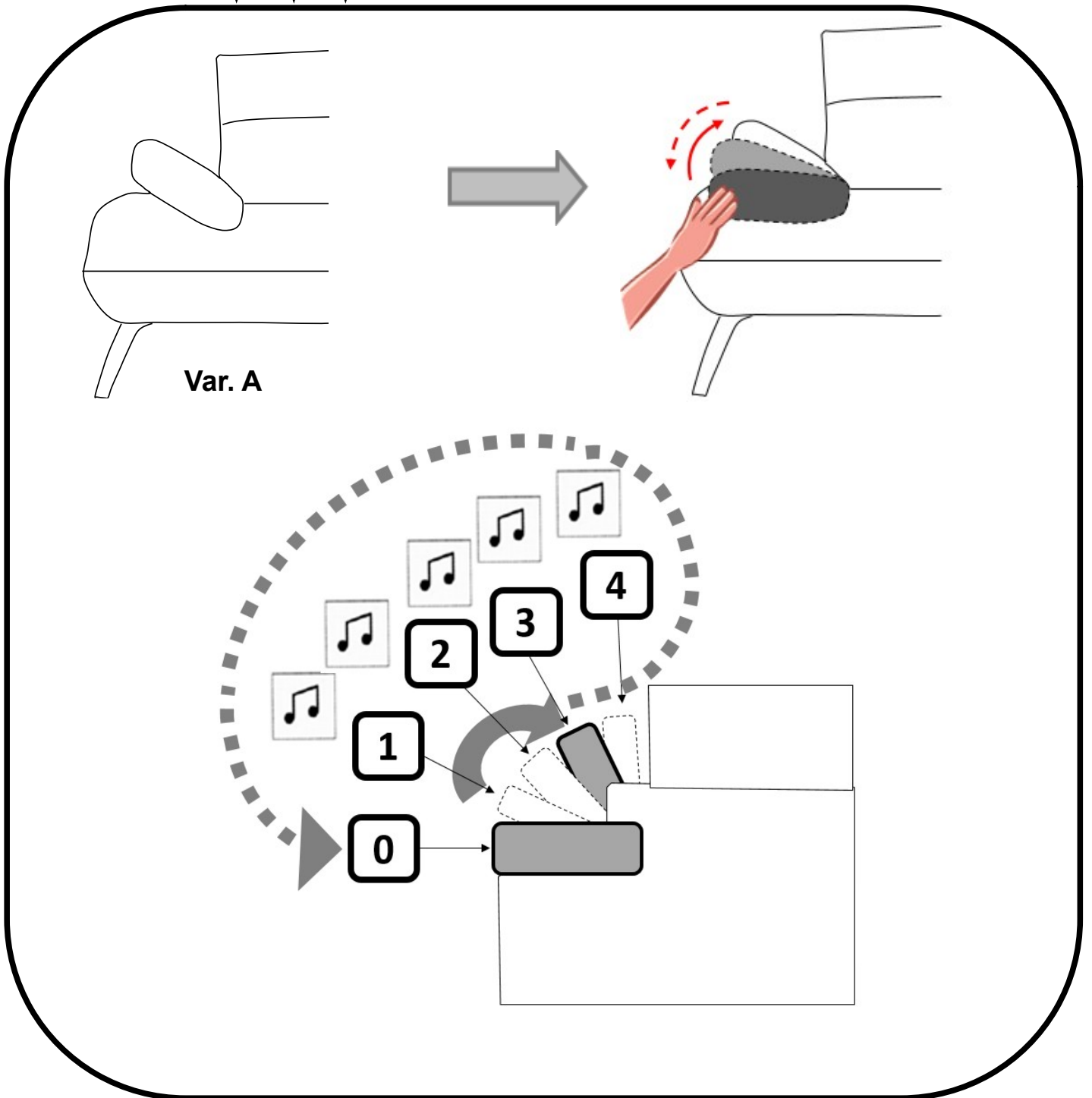
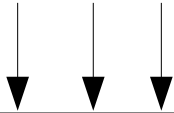
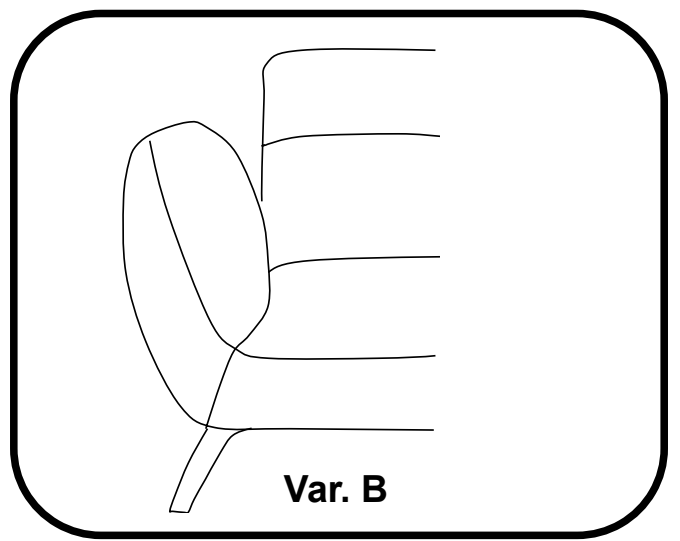
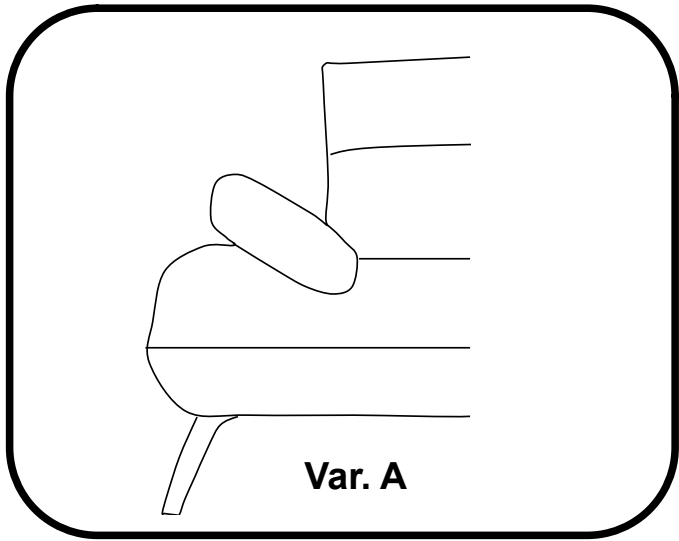

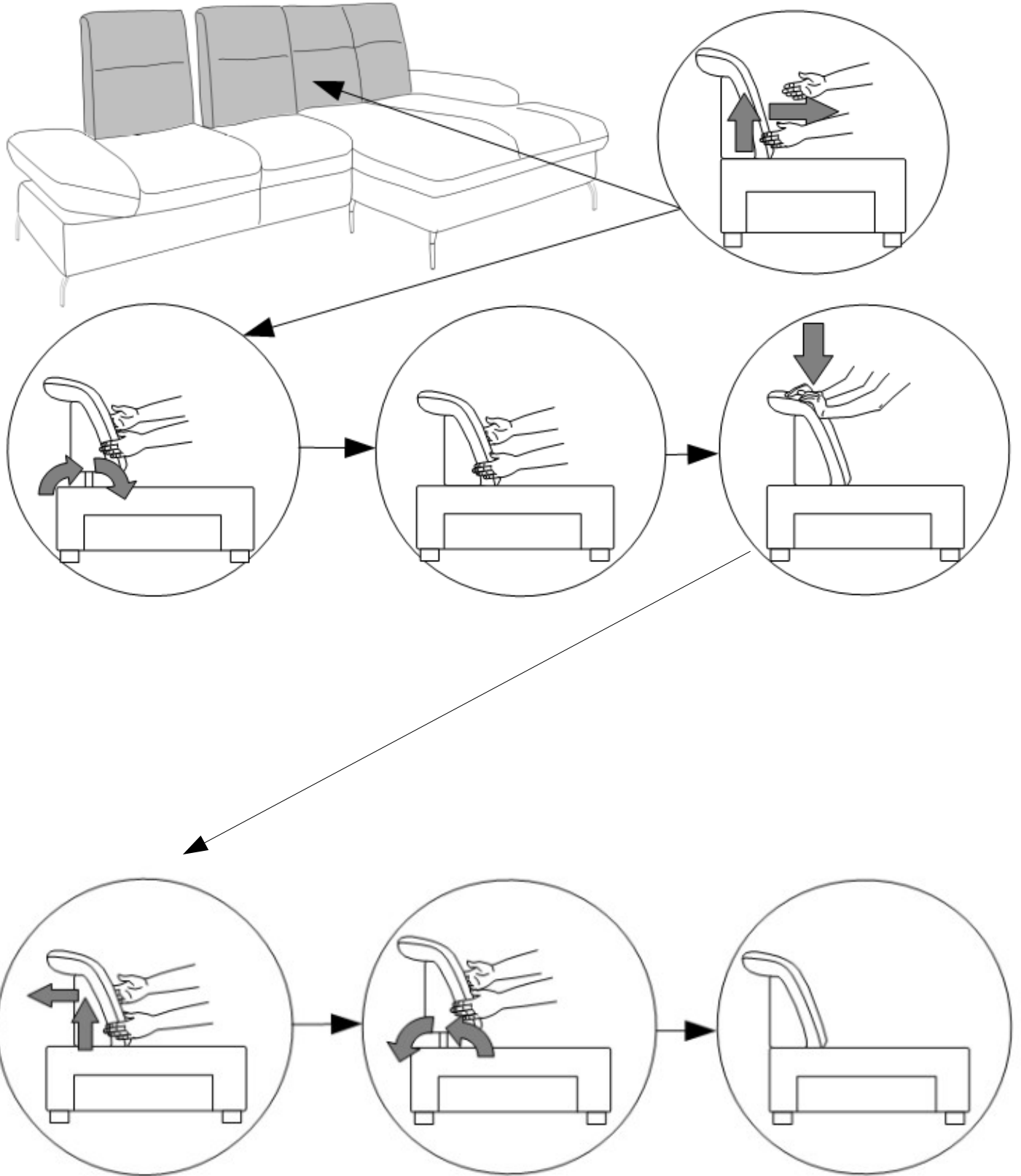
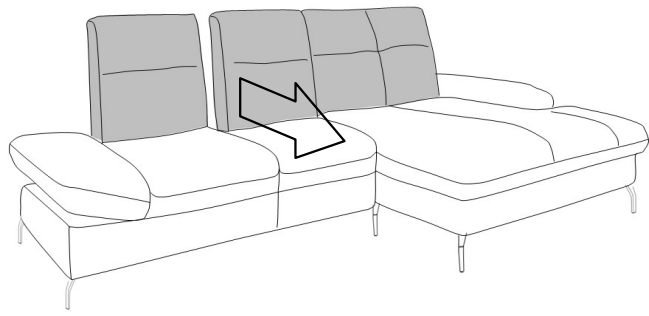

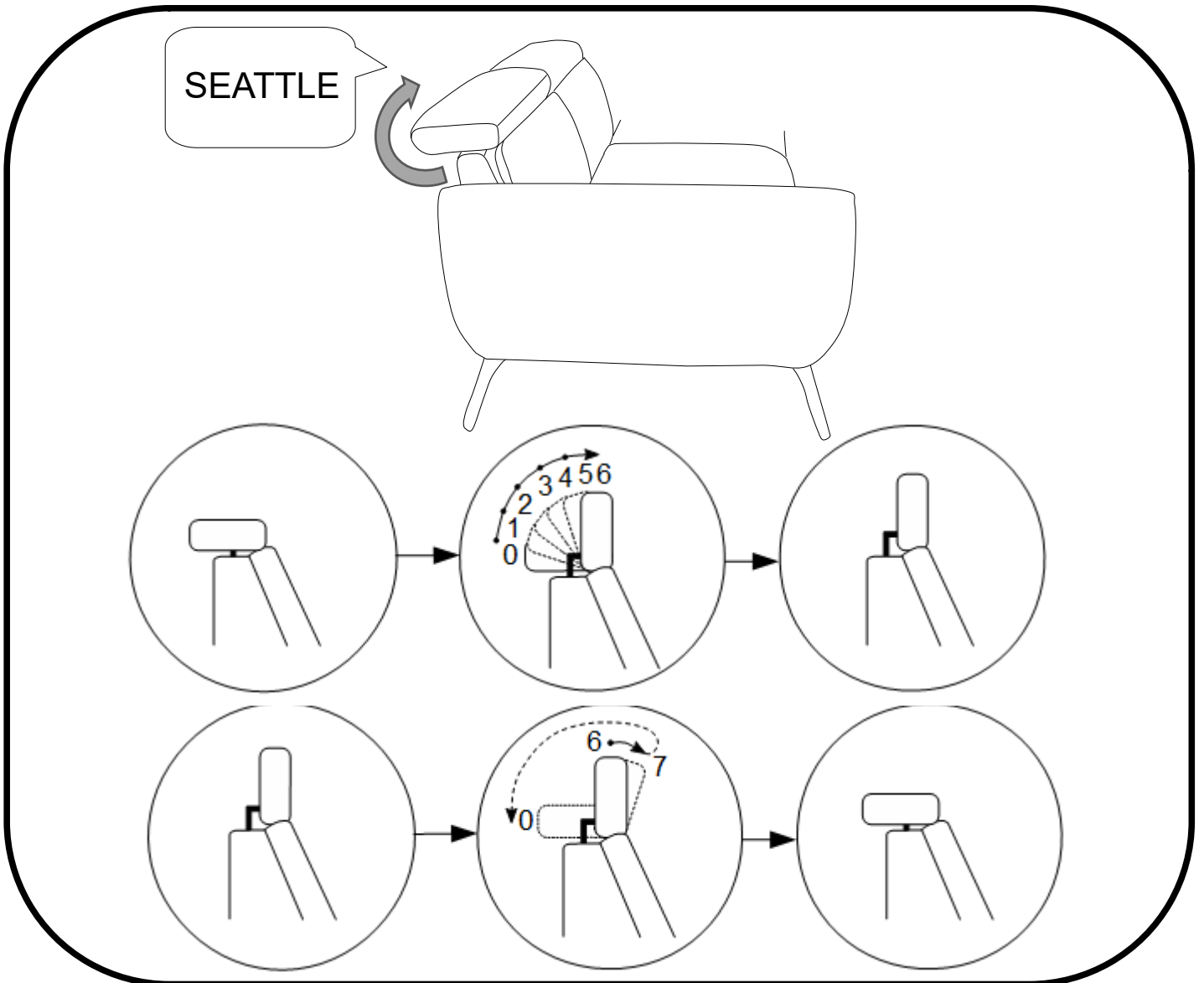
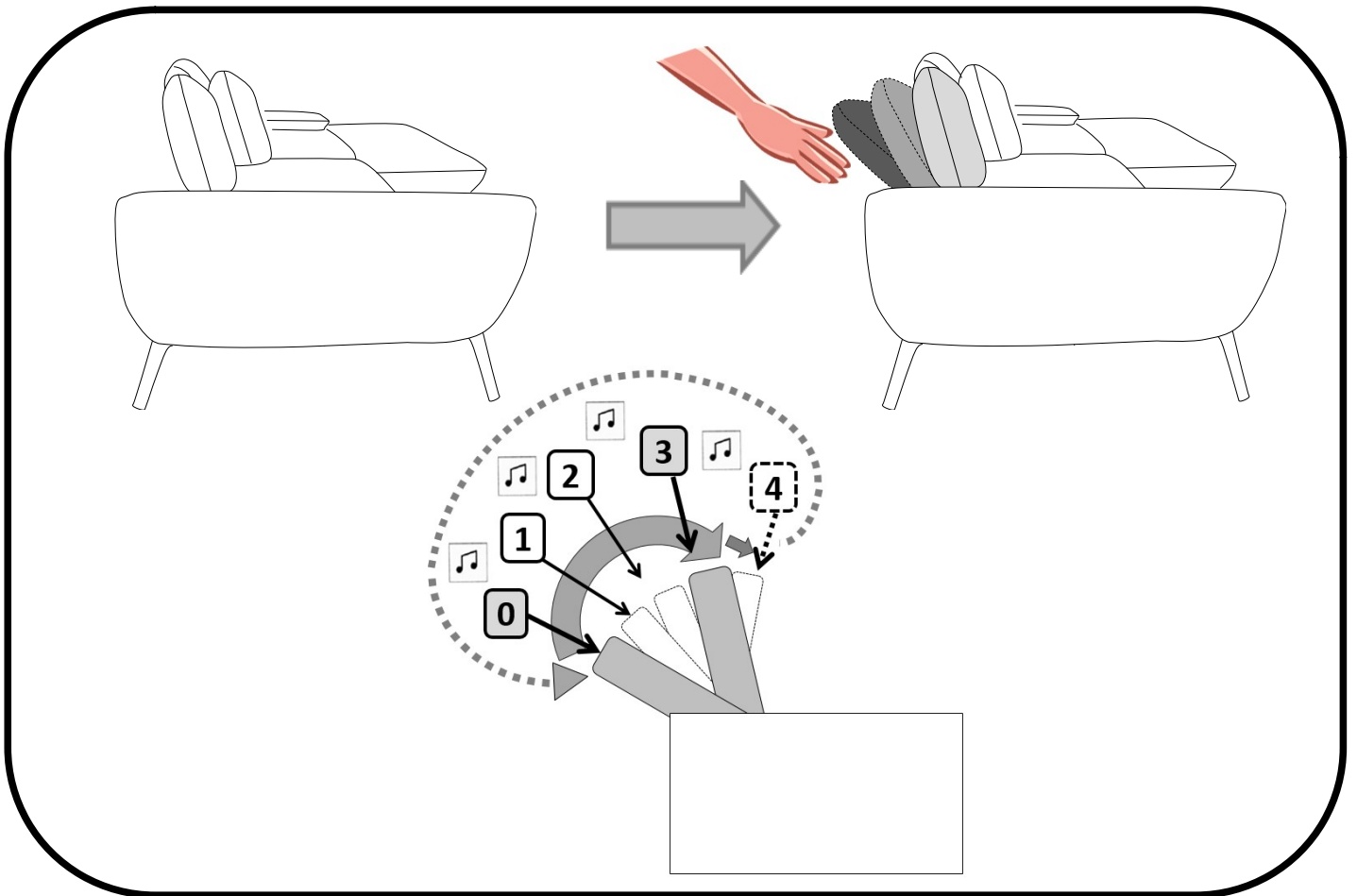

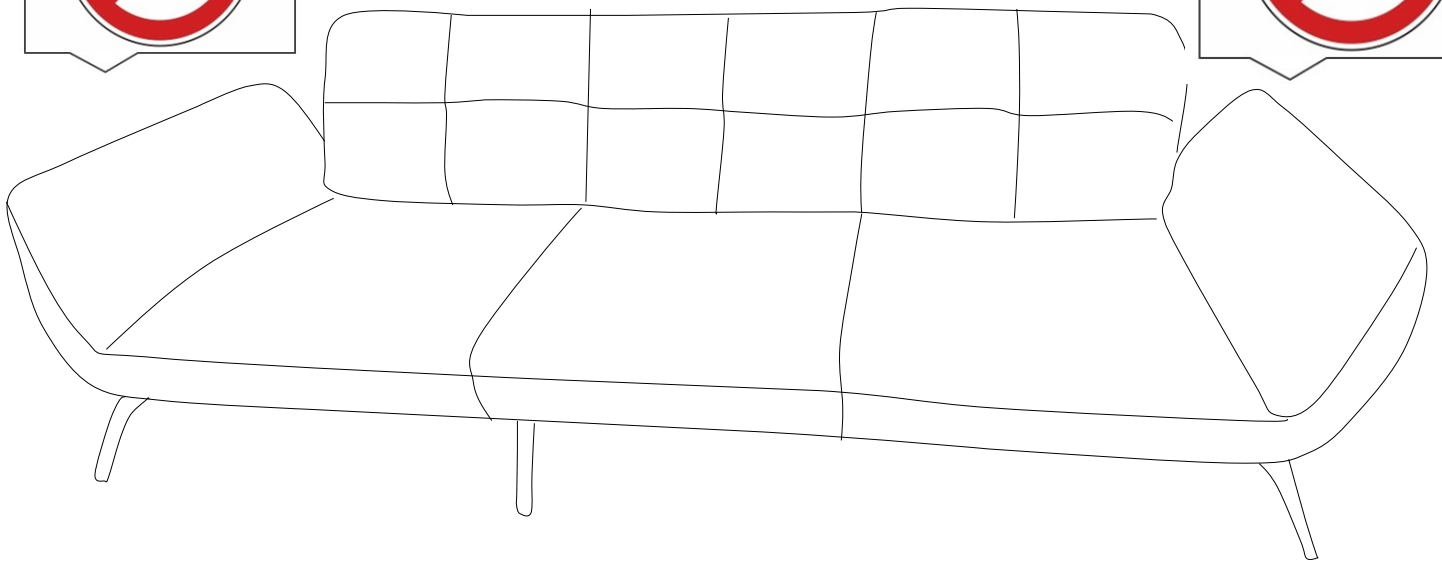

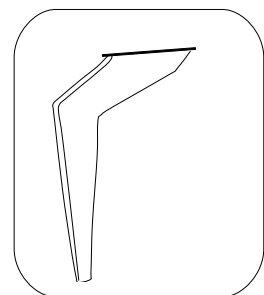
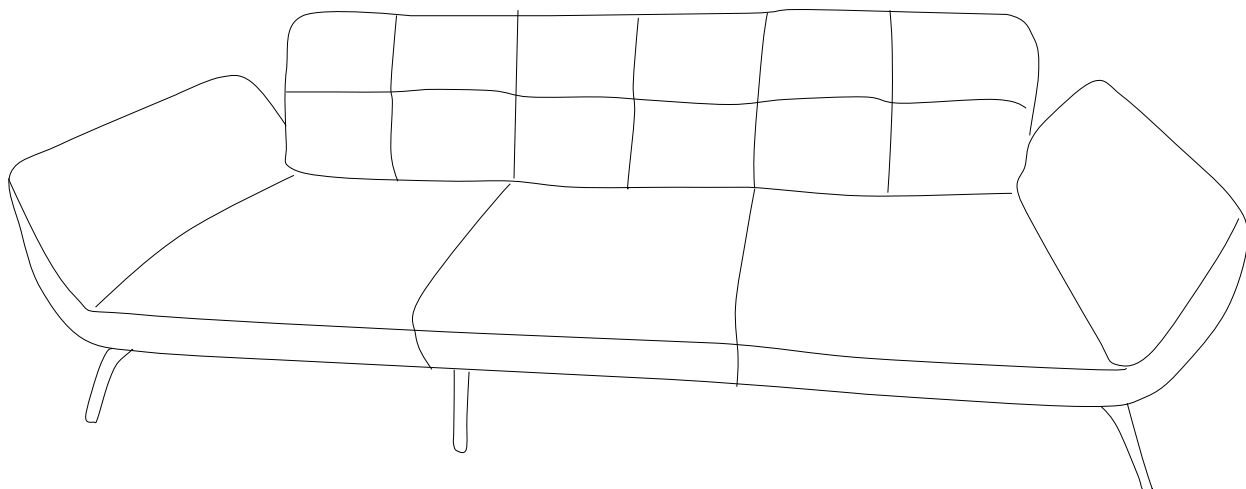
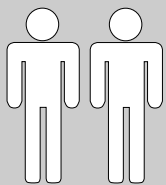

VITO TICONA / PAYTON

V.03.-02.2022

- |           |  |           |   |
|-----------|--|-----------|---|
| <b>D</b>  | MONTAGEANLEITUNG<br>BEDIENUNGSANLEITUNG                | <b>GB</b> | ASSEMBLY INSTRUCTIONS<br>INSTRUCTION MANUAL         |
| <b>NL</b> | HANDLEIDING VOOR DE MONTAGE<br>GEBRUIKSAANWIJZING      | <b>PL</b> | INSTRUKCJA MONTAŻU<br>INSTRUKCJA OBSŁUGI            |
| <b>TR</b> | MONTAJ TALIMATI<br>KULLANIM KLAVUZU                    | <b>RU</b> | ИНСТРУКЦИЯ ПО МОНТАЖУ<br>ИНСТРУКЦИЯ ПО ЭКСПЛУАТАЦИИ |
| <b>RO</b> | INSTRUCȚIUNI DE INSTALARE<br>INSTRUCȚIUNI DE UTILIZARE | <b>IT</b> | ISTRUZIONI DI MONTAGGIO<br>MANUALE DI ISTRUZIONI    |
| <b>FR</b> | NOTICE DE MONTAGE<br>MANUEL INSTRUCTIONS               | <b>SK</b> | MONTÁŽNY NÁVOD<br>NÁVOD NA POUŽITIE                 |
| <b>HU</b> | KÖZGYŰLÉS UTASÍTÁSOK<br>KEZELÉSI UTASÍTÁS              | <b>CZ</b> | MONTÁŽNÍ NÁVOD<br>NÁVOD K POUŽITÍ                   |
| <b>SI</b> | NAVODILA ZA MONTAŽO<br>NAVODILA ZA UPORABO             | <b>PT</b> | INSTRUÇÕES DE MONTAGEM<br>MANUAL DO USUÁRIO         |
| <b>ES</b> | INSTRUCCIONES DE MONTAJE<br>MANUAL DEL USUARIO         | <b>HR</b> | UPUTE ZA MONTAŽU<br>UPUTE ZA UPOTREBU               |

Service · Dienstverlening · Serwis · Servis · Сервисная служба · Serviciu · Services · Servizio · Servisný list · Szolgáltatás · Servisní list

Name · Naam · Nazwa · Ísim · Название · Nume · Nome ·  
Názov · Názov · Název · Neve

VITO TICONA / PAYTON

Тип · Type · Tip · Тип · Tipo · Típus

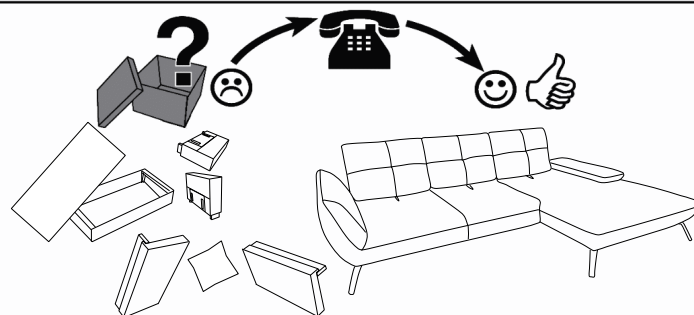
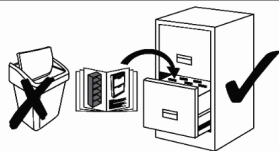

✓						
		2 x A 2 x a1	2x3B	1x		
		4 x A 4 x a1	2x4B + 2x3B	1x		
		2 x A 2 x a1	2x3B	2x		
		4 x A 4 x a1	2x4B + 2x3B	2x		
		2 x A 2 x a1	2x3B	/		1x
		4 x A 4 x a1	2x4B + 2x3B	/		
		2 x A 2 x a1	2x3B	1x		
		4 x A 4 x a1	2x4B + 2x3B	1x		

Service · Dienstverlening · Serwis · Servis · Сервисная служба · Serviciu ·  
Services · Servizio · Servisný list · Szolgáltatás · Servisní list

Name · Naam · Nazwa · İsim · Название · Nume · Nome ·  
Názov · Názov · Název · Neve

VITO TICONA / PAYTON

Typ · Type · Tip · Тип · Tipo · Típus

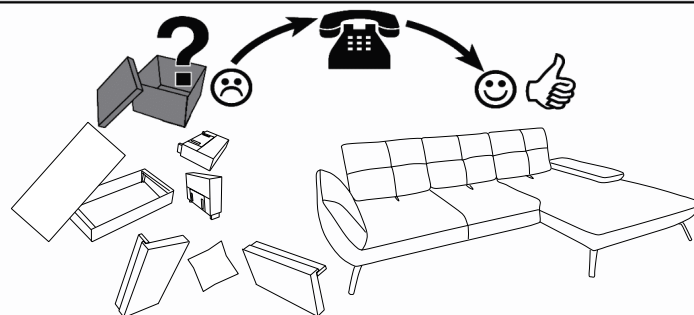
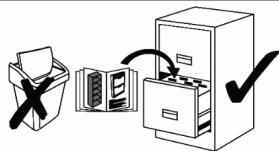

✓					
		a1	M6x25		L4
		2 x A 2 x a1	2x4B	1x	1x
		4 x A 4 x a1	4x4B	1x	
		2 x A 2 x a1	2x4B	2x	
		4 x A 4 x a1	4x4B	2x	
		2 x A 2 x a1	2x4B	/	
		4 x A 4 x a1	4x4B	/	
		2 x A 2 x a1	2x4B	1x	
		4 x A 4 x a1	4x4B	1x	



## Zusatzinformation für die Fußmontage

### ACHTUNG!

Bitte beachten Sie, dass bei dieser Zusammenstellung die FüÙe aussen schräg und die mittleren FüÙe gerade montiert werden.

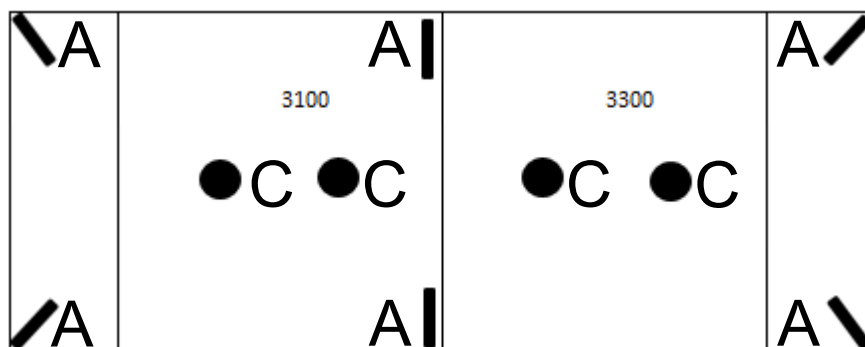
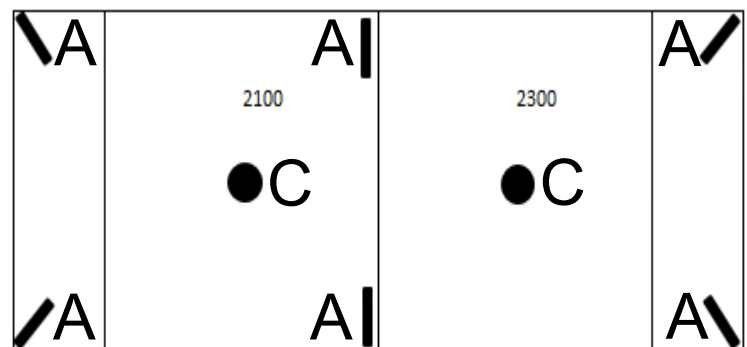
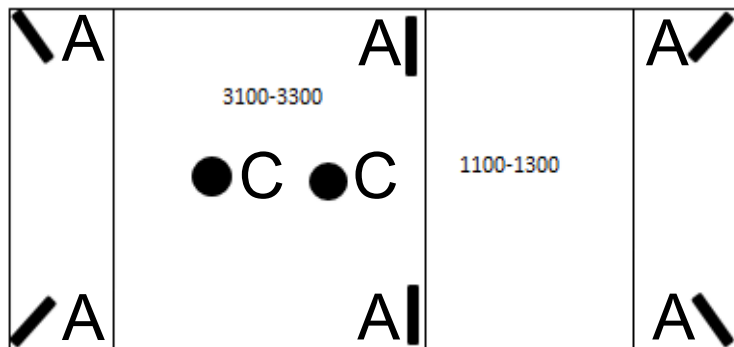
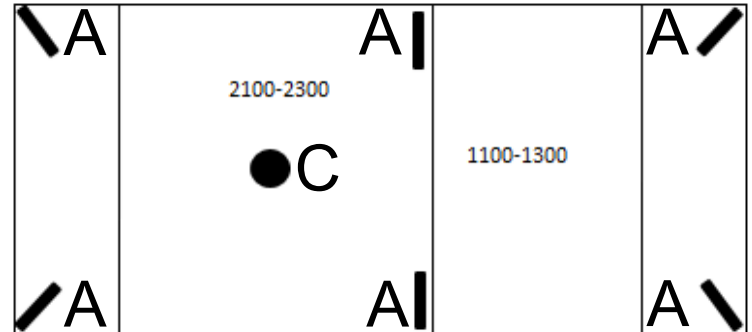
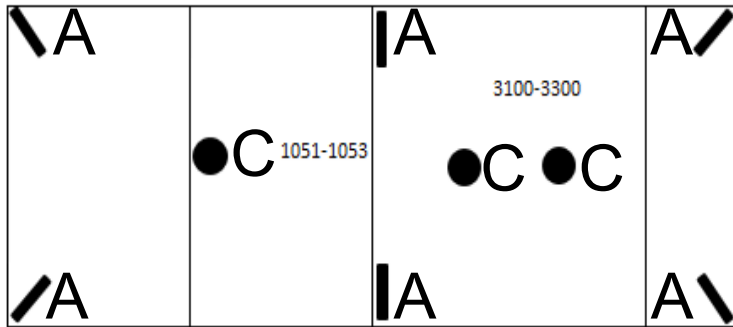
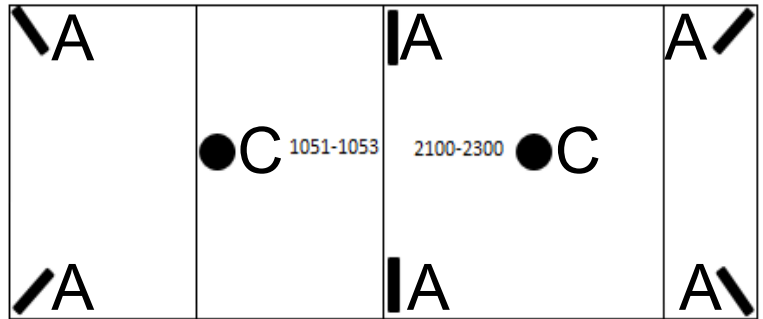
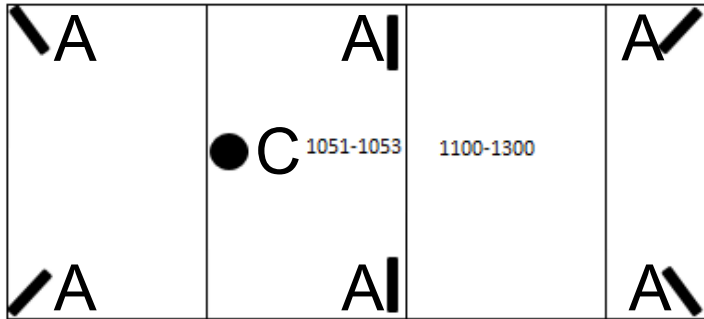

## Zusatzinformation für die Fußmontage

### ACHTUNG!

Bitte beachten Sie, dass bei dieser Zusammenstellung die FüÙe aussen schräg und die mittleren FüÙe gerade montiert werden.

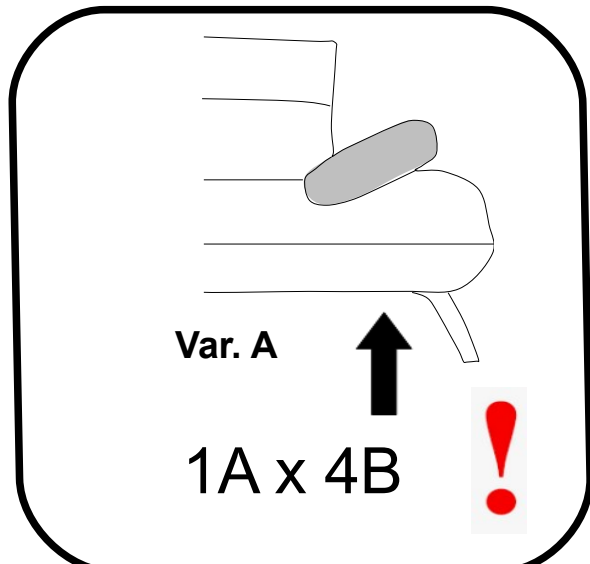
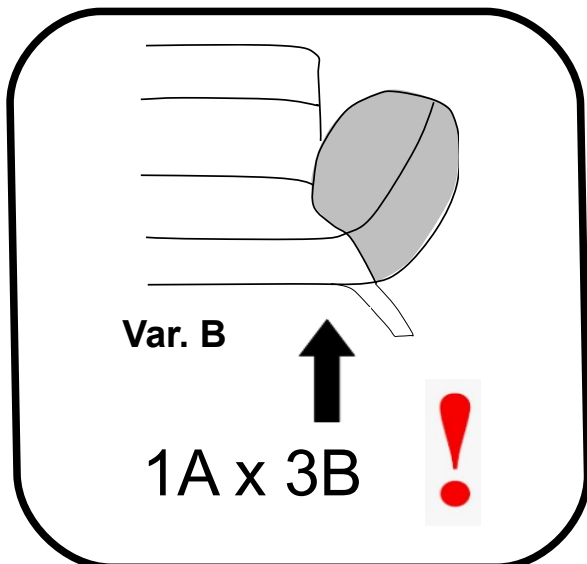
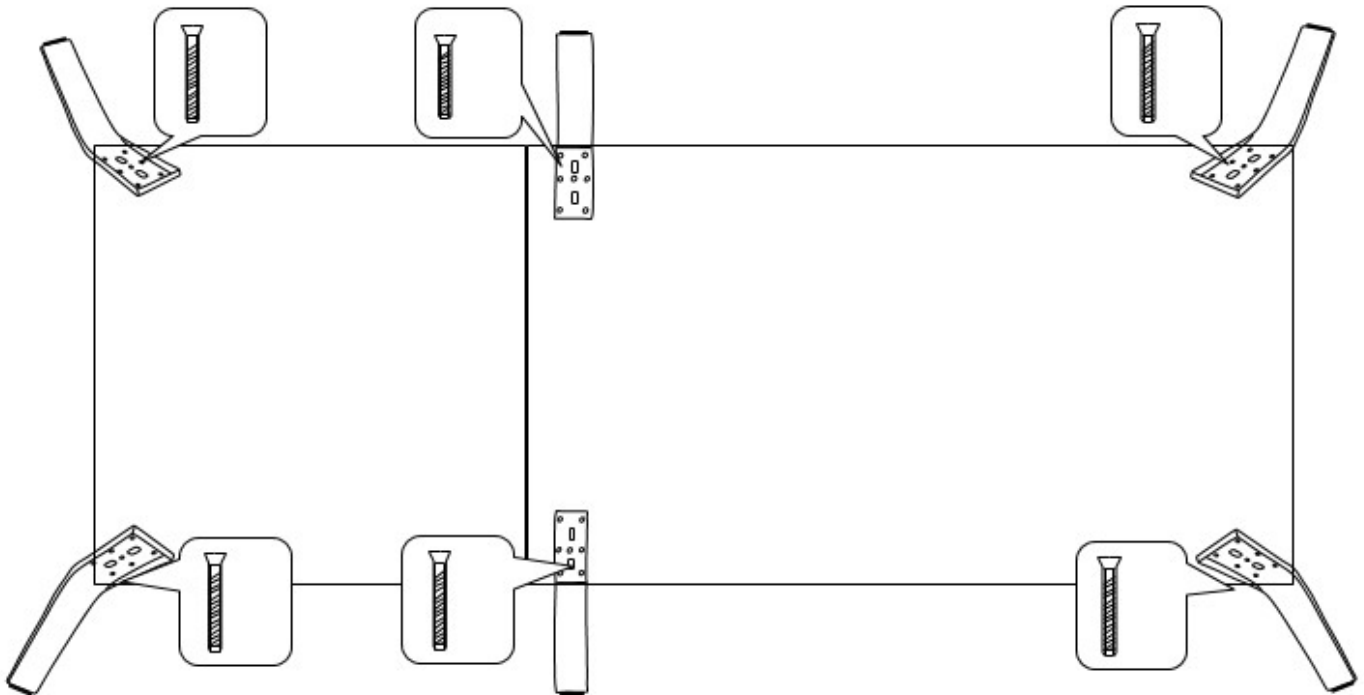
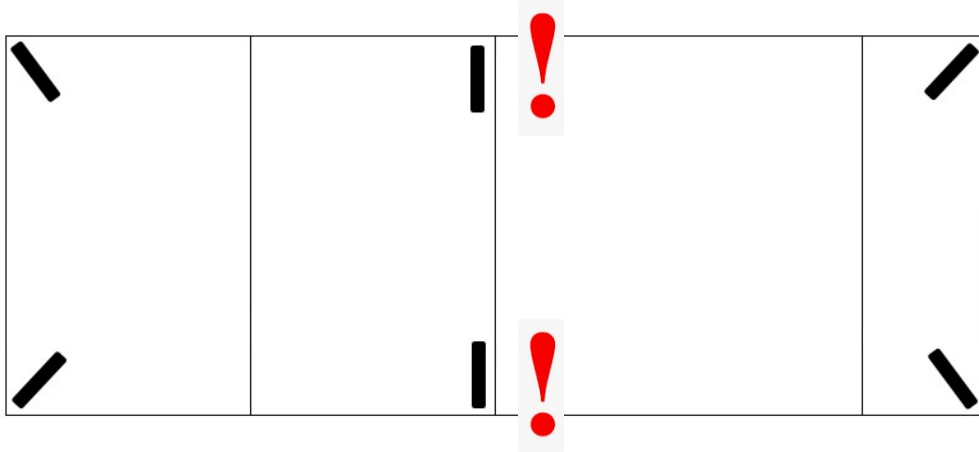

1

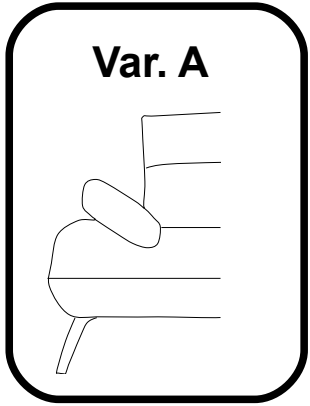
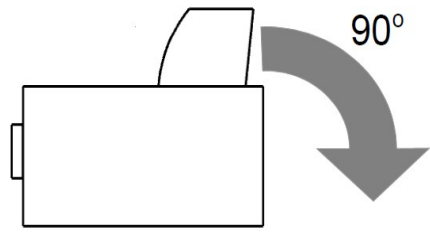

A

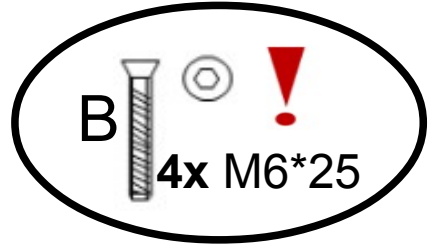

a1

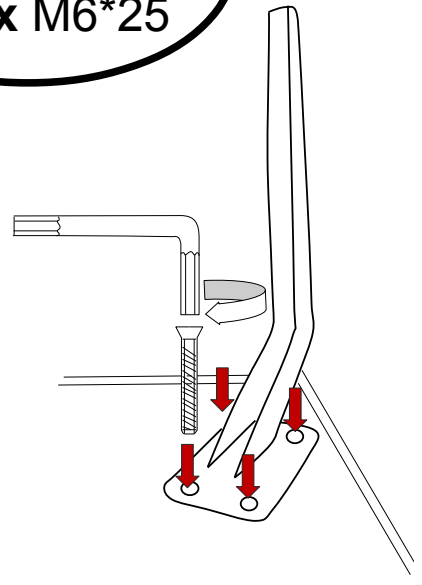
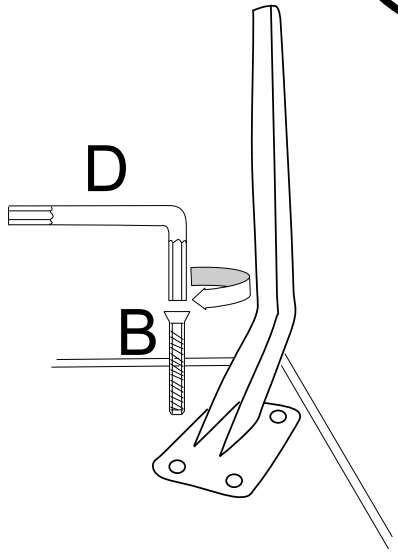

2

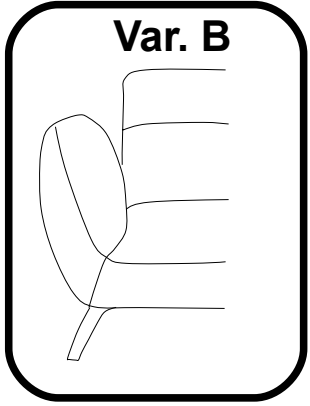

A



a1

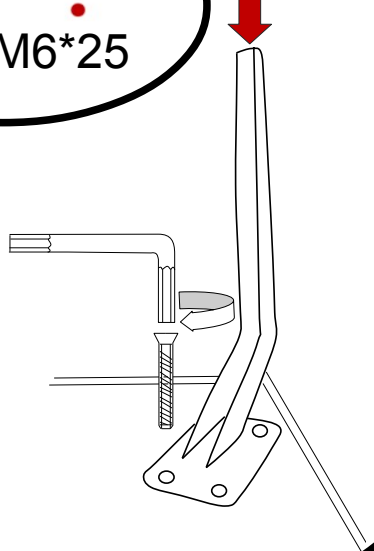
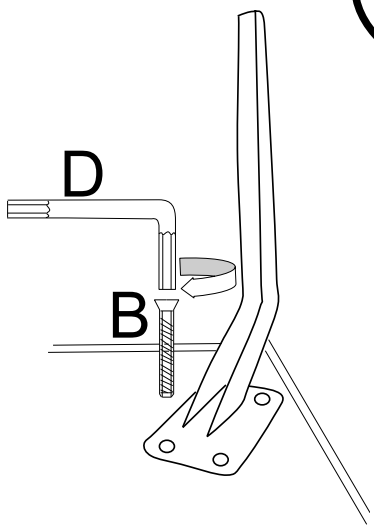

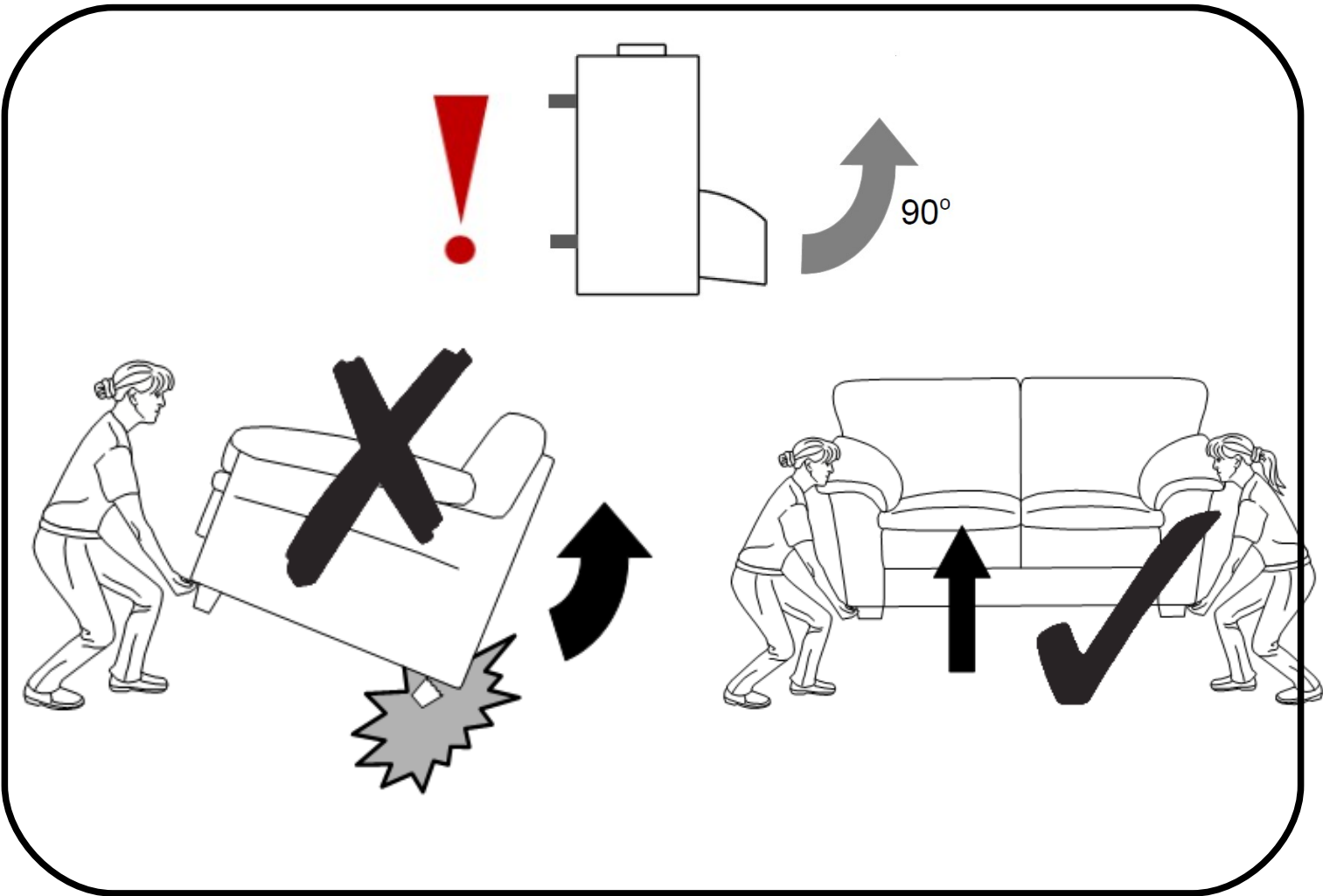
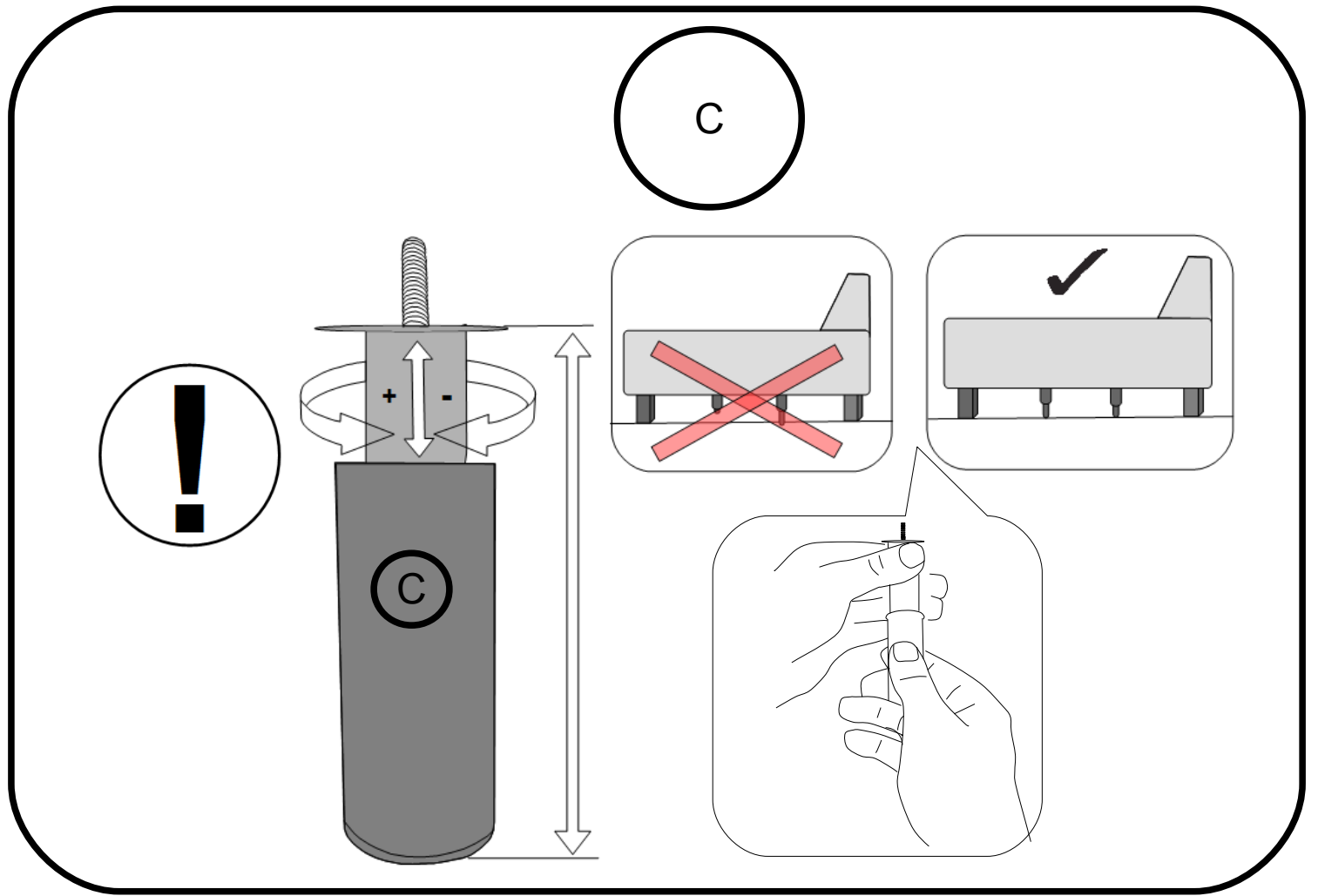

1

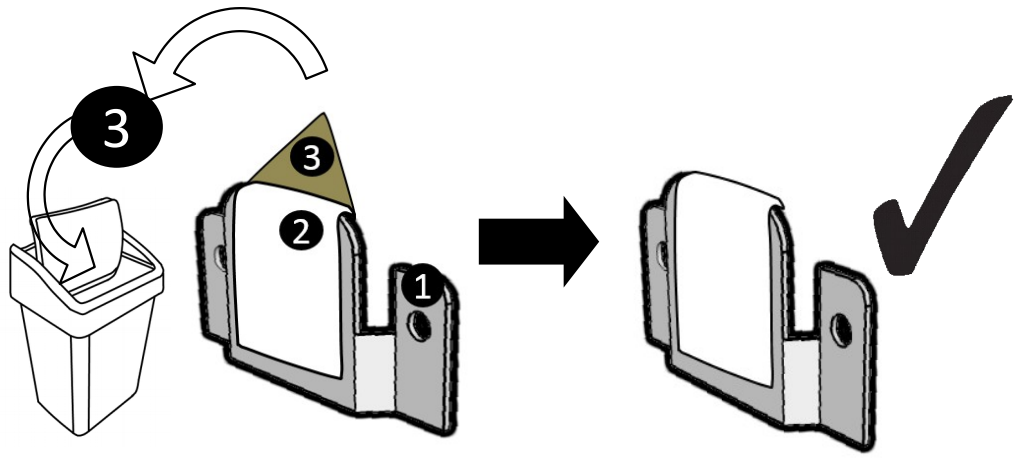

2

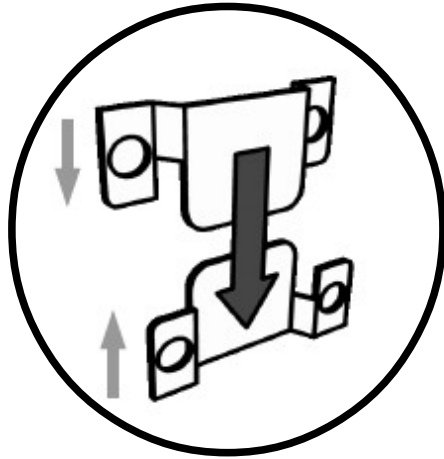

3

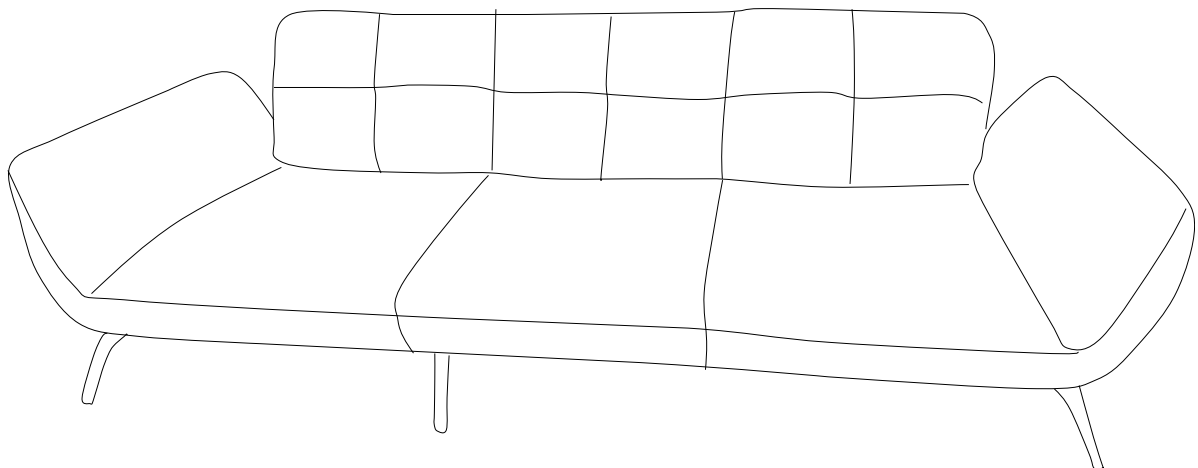
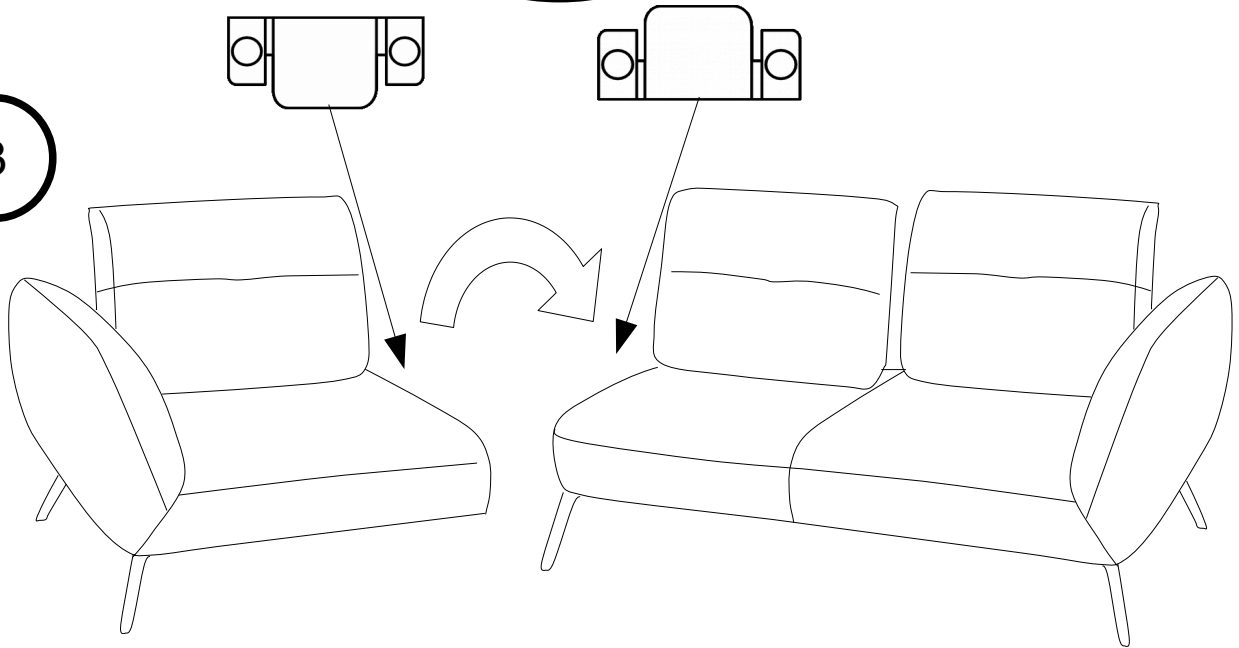

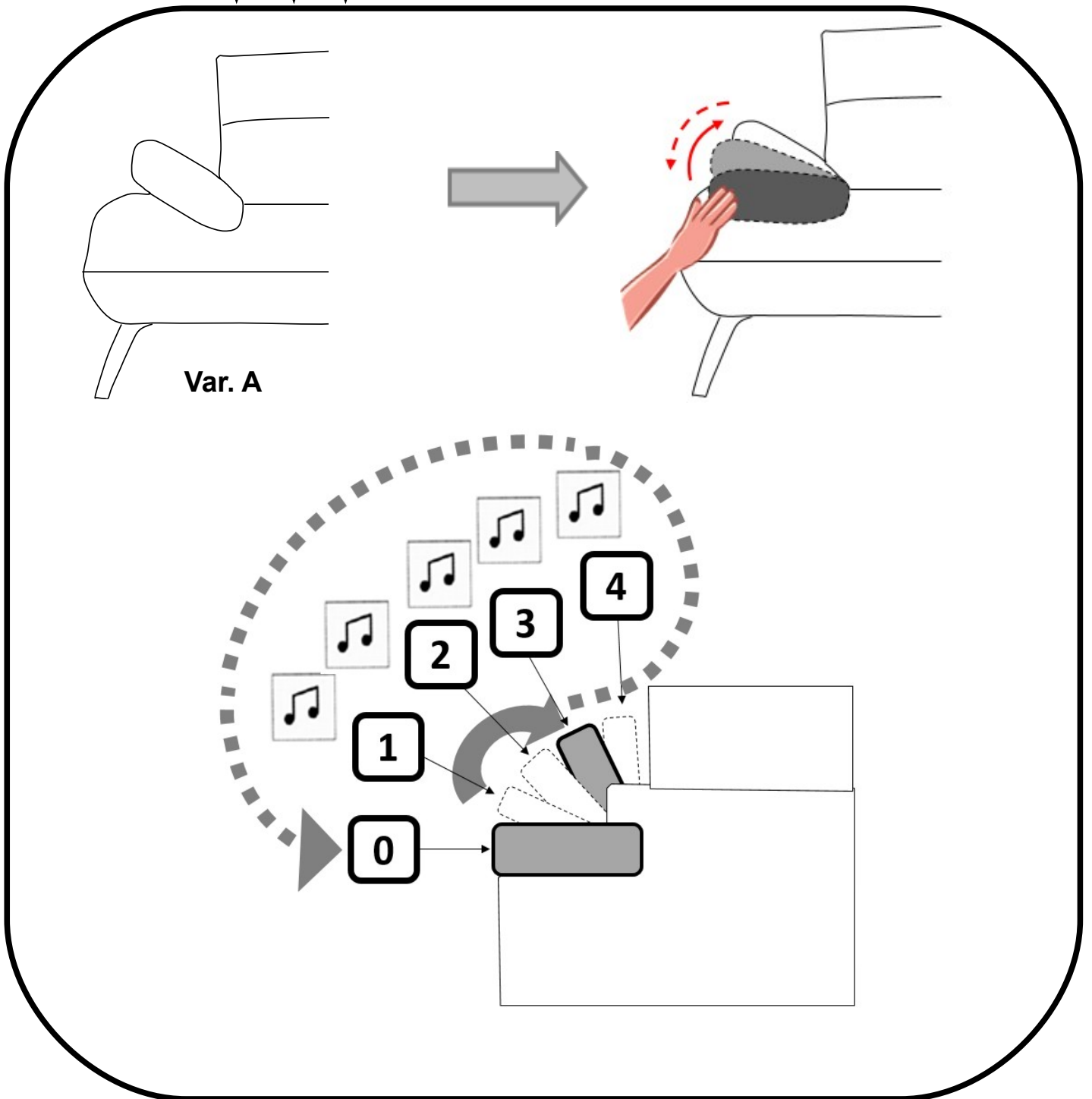
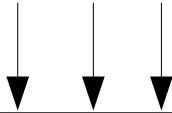
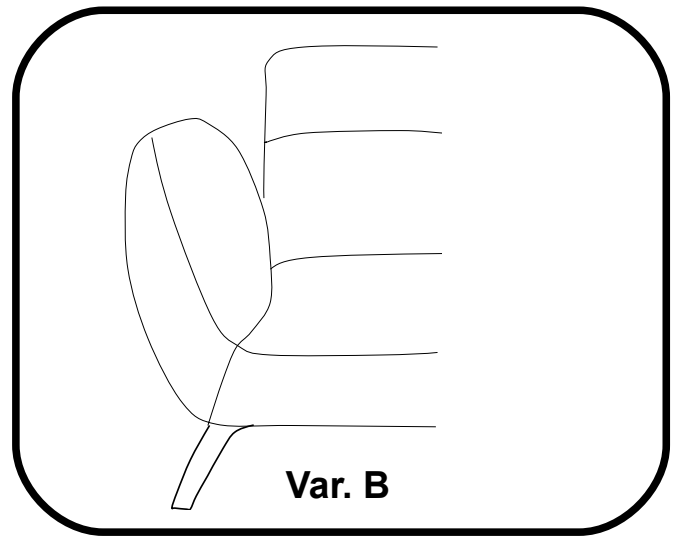
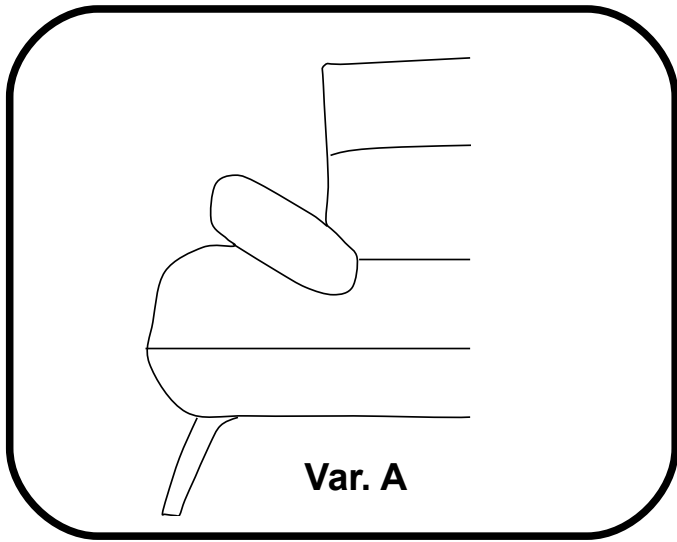

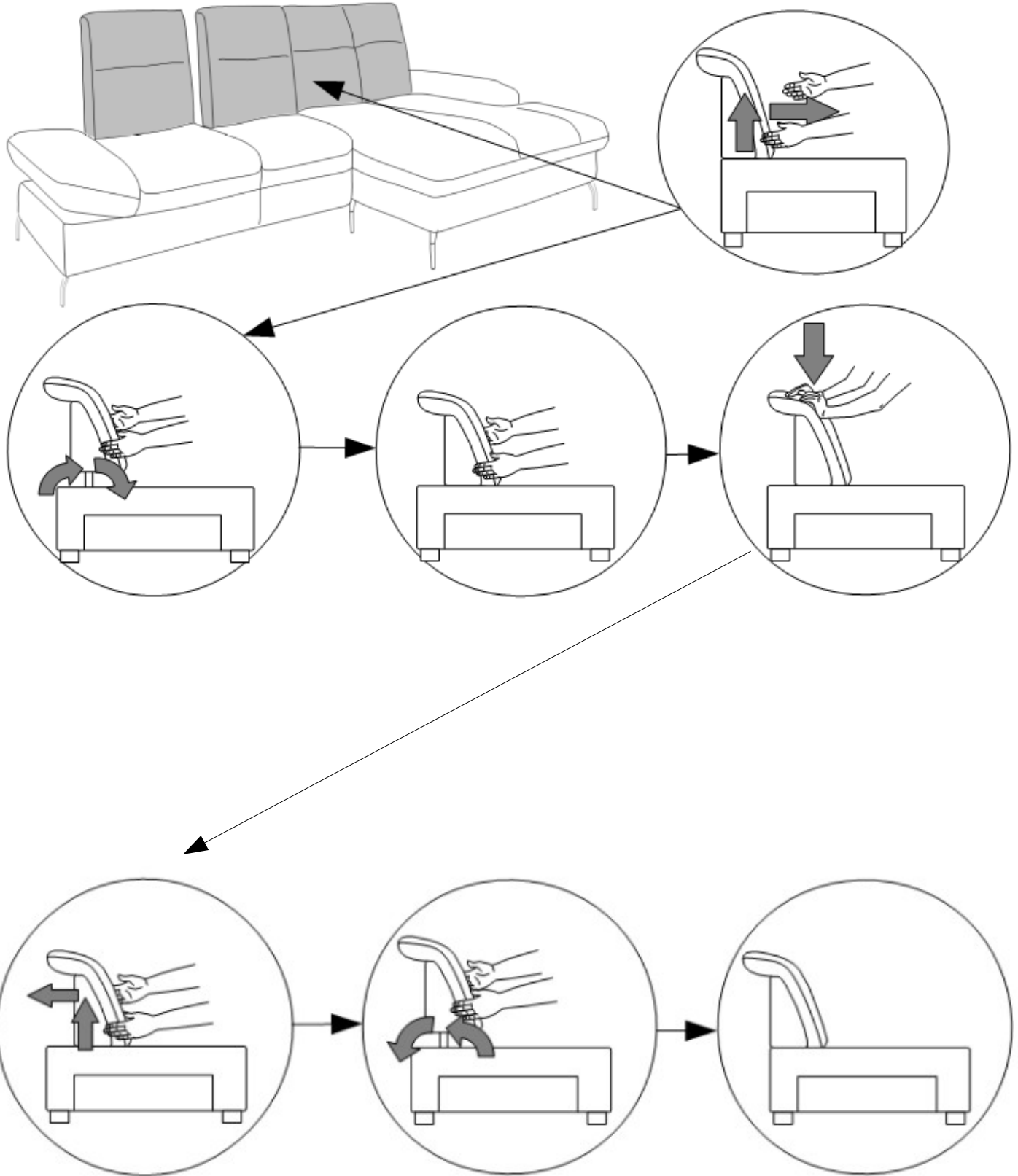
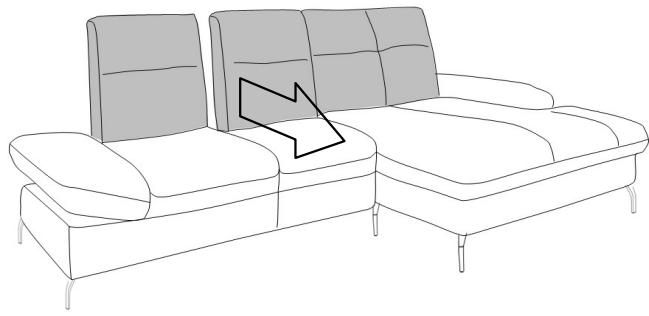

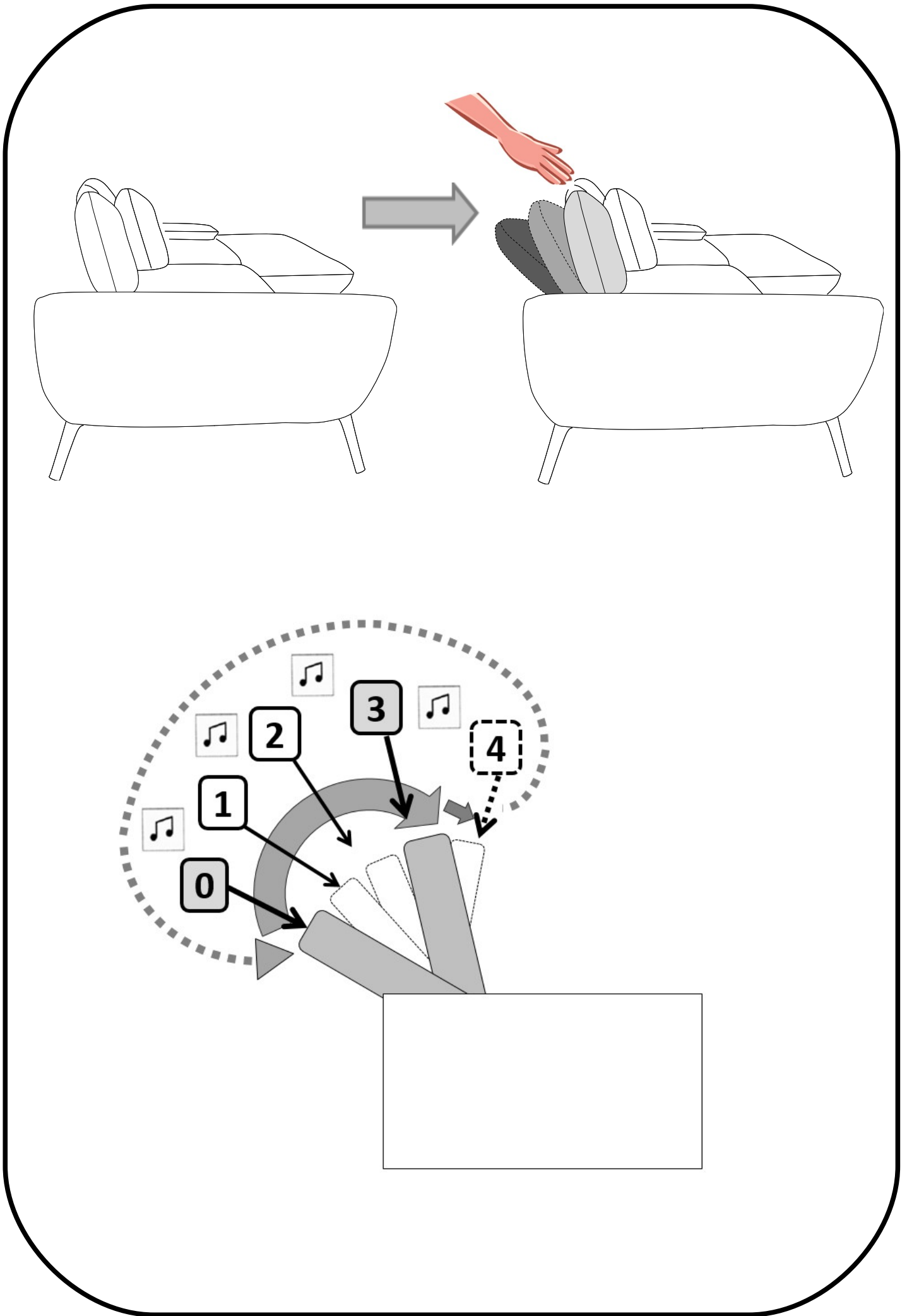



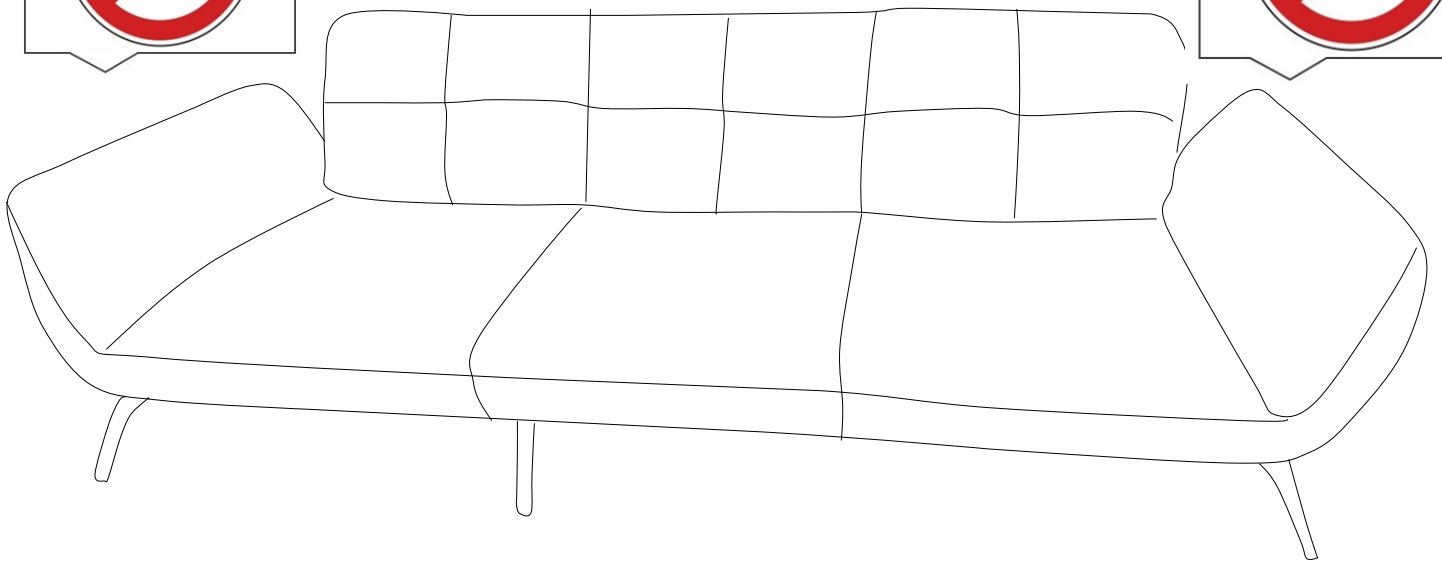

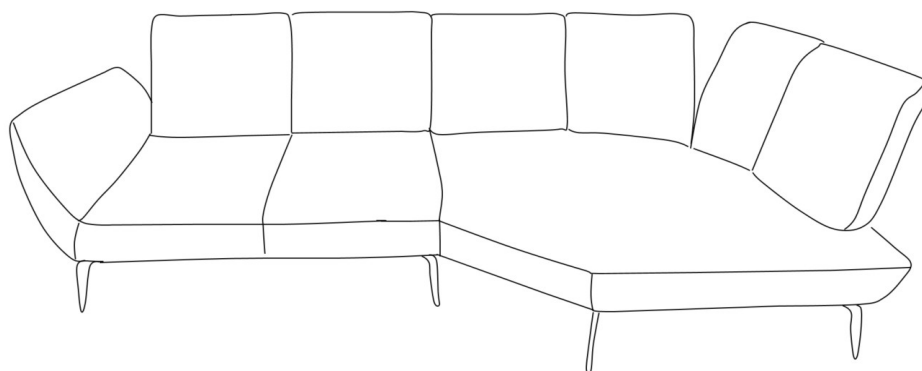
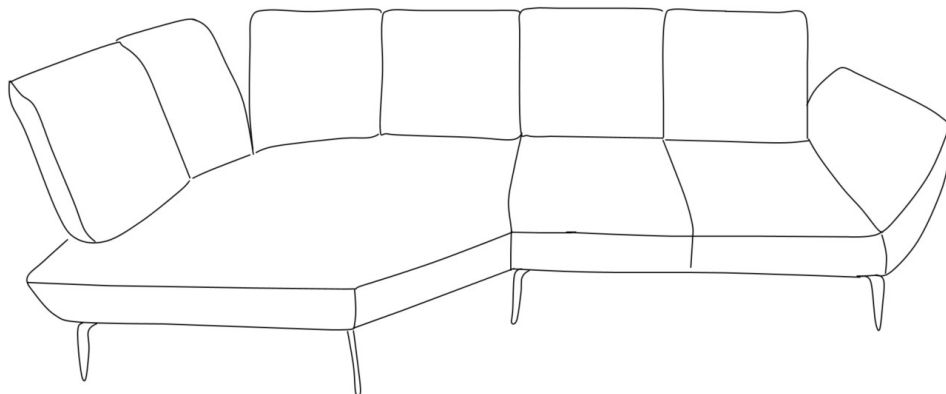
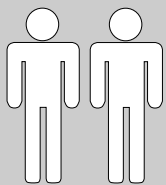

- |           |  |           |   |
|-----------|--|-----------|---|
| <b>D</b>  | MONTAGEANLEITUNG<br>BEDIENUNGSANLEITUNG                | <b>GB</b> | ASSEMBLY INSTRUCTIONS<br>INSTRUCTION MANUAL         |
| <b>NL</b> | HANDLEIDING VOOR DE MONTAGE<br>GEBRUIKSAANWIJZING      | <b>PL</b> | INSTRUKCJA MONTAŻU<br>INSTRUKCJA OBSŁUGI            |
| <b>TR</b> | MONTAJ TALIMATI<br>KULLANIM KLAVUZU                    | <b>RU</b> | ИНСТРУКЦИЯ ПО МОНТАЖУ<br>ИНСТРУКЦИЯ ПО ЭКСПЛУАТАЦИИ |
| <b>RO</b> | INSTRUCȚIUNI DE INSTALARE<br>INSTRUCȚIUNI DE UTILIZARE | <b>IT</b> | ISTRUZIONI DI MONTAGGIO<br>MANUALE DI ISTRUZIONI    |
| <b>FR</b> | NOTICE DE MONTAGE<br>MANUEL INSTRUCTIONS               | <b>SK</b> | MONTÁŽNY NÁVOD<br>NÁVOD NA POUŽITIE                 |
| <b>HU</b> | KÖZGYŰLÉS UTASÍTÁSOK<br>KEZELÉSI UTASÍTÁS              | <b>CZ</b> | MONTÁŽNÍ NÁVOD<br>NÁVOD K POUŽITÍ                   |
| <b>SI</b> | NAVODILA ZA MONTAŽO<br>NAVODILA ZA UPORABO             | <b>PT</b> | INSTRUÇÕES DE MONTAGEM<br>MANUAL DO USUÁRIO         |
| <b>ES</b> | INSTRUCCIONES DE MONTAJE<br>MANUAL DEL USUARIO         | <b>HR</b> | UPUTE ZA MONTAŽU<br>UPUTE ZA UPOTREBU               |

# Montageanleitung vom Eckelement mit dem Steckruecken

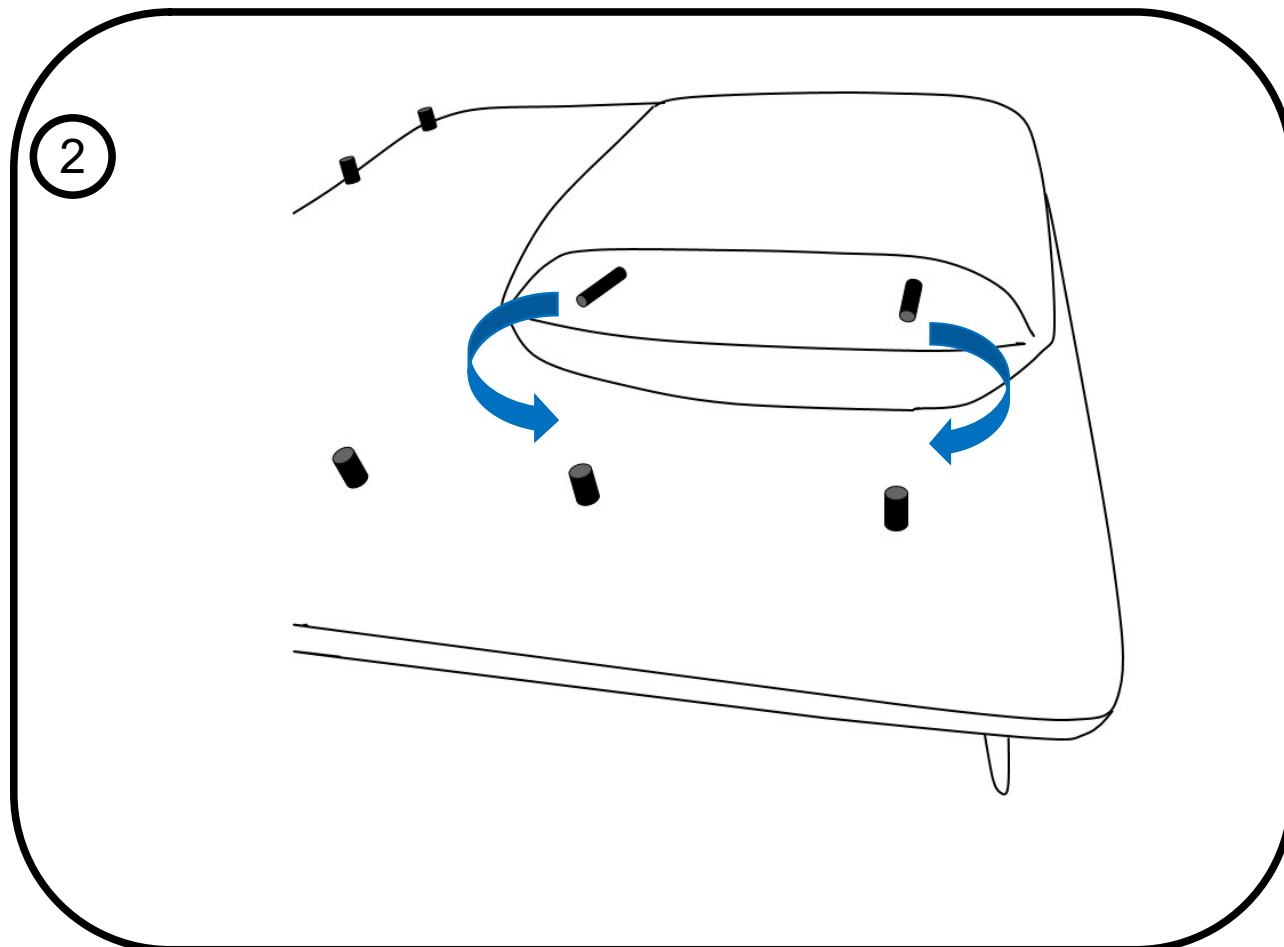
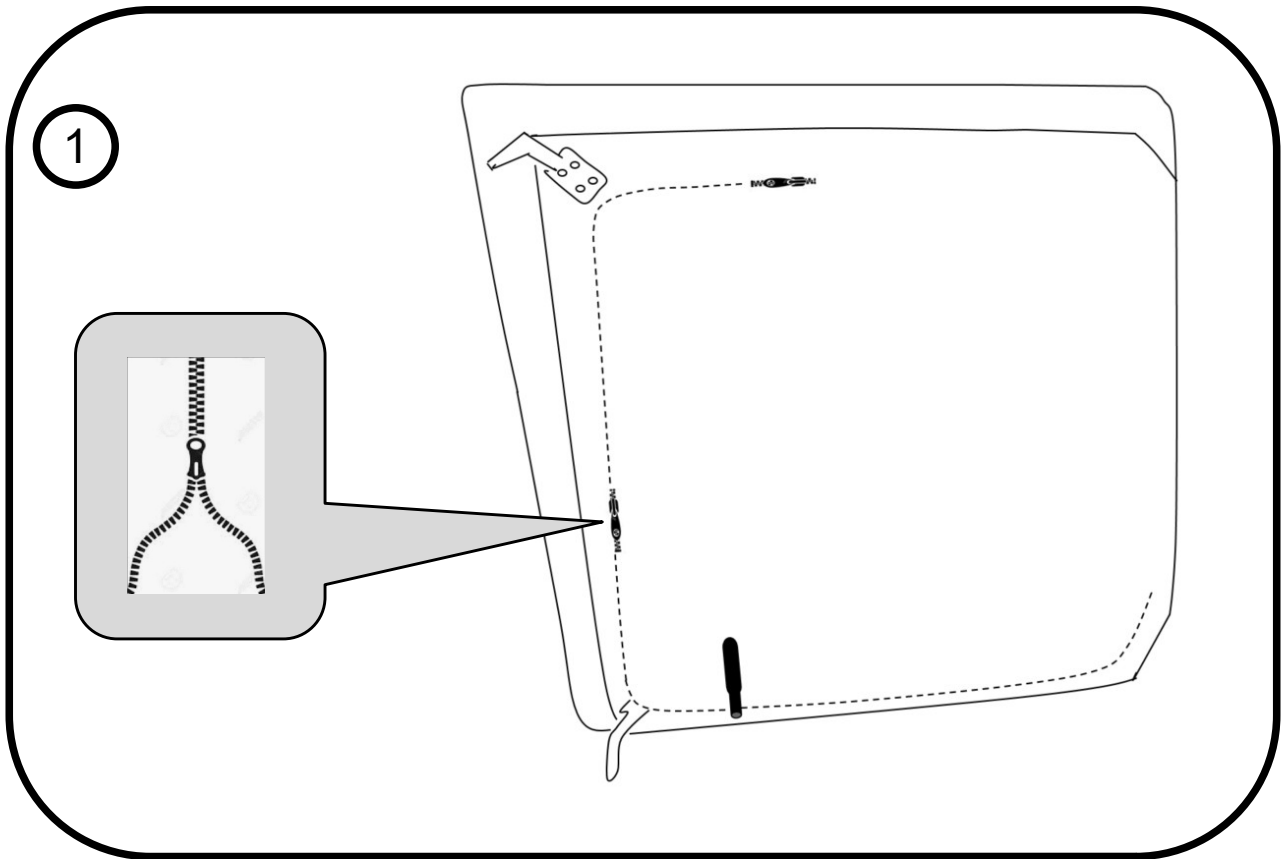

3

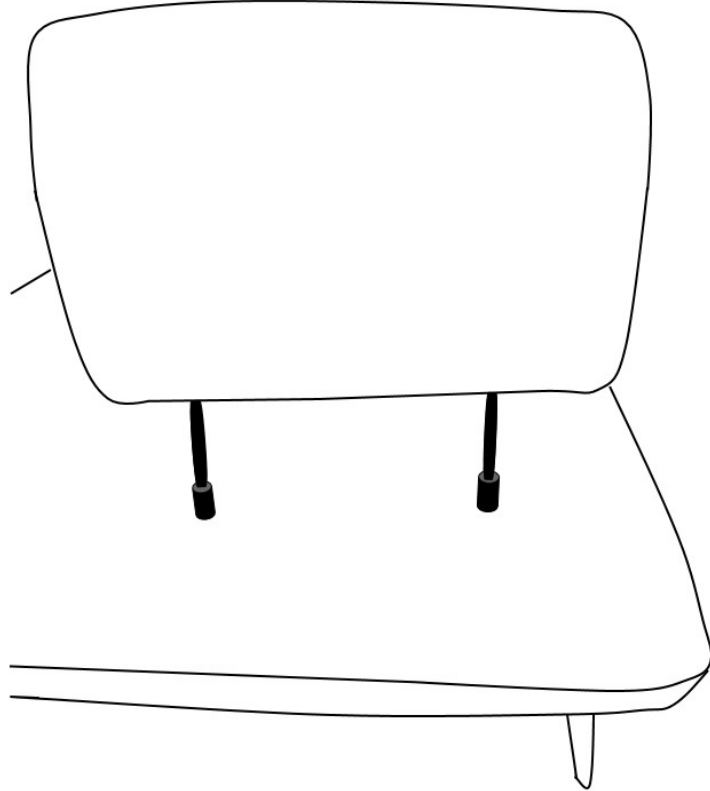

4

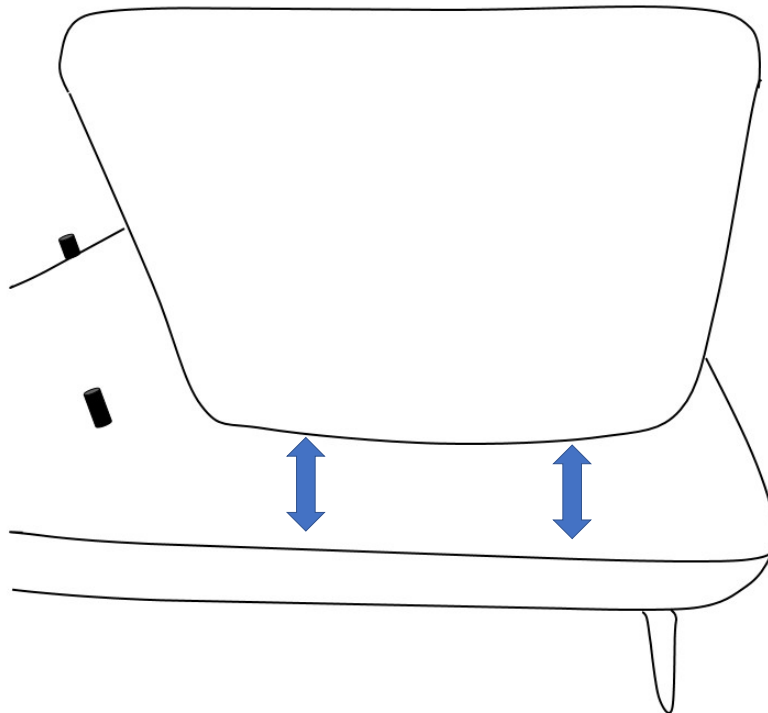

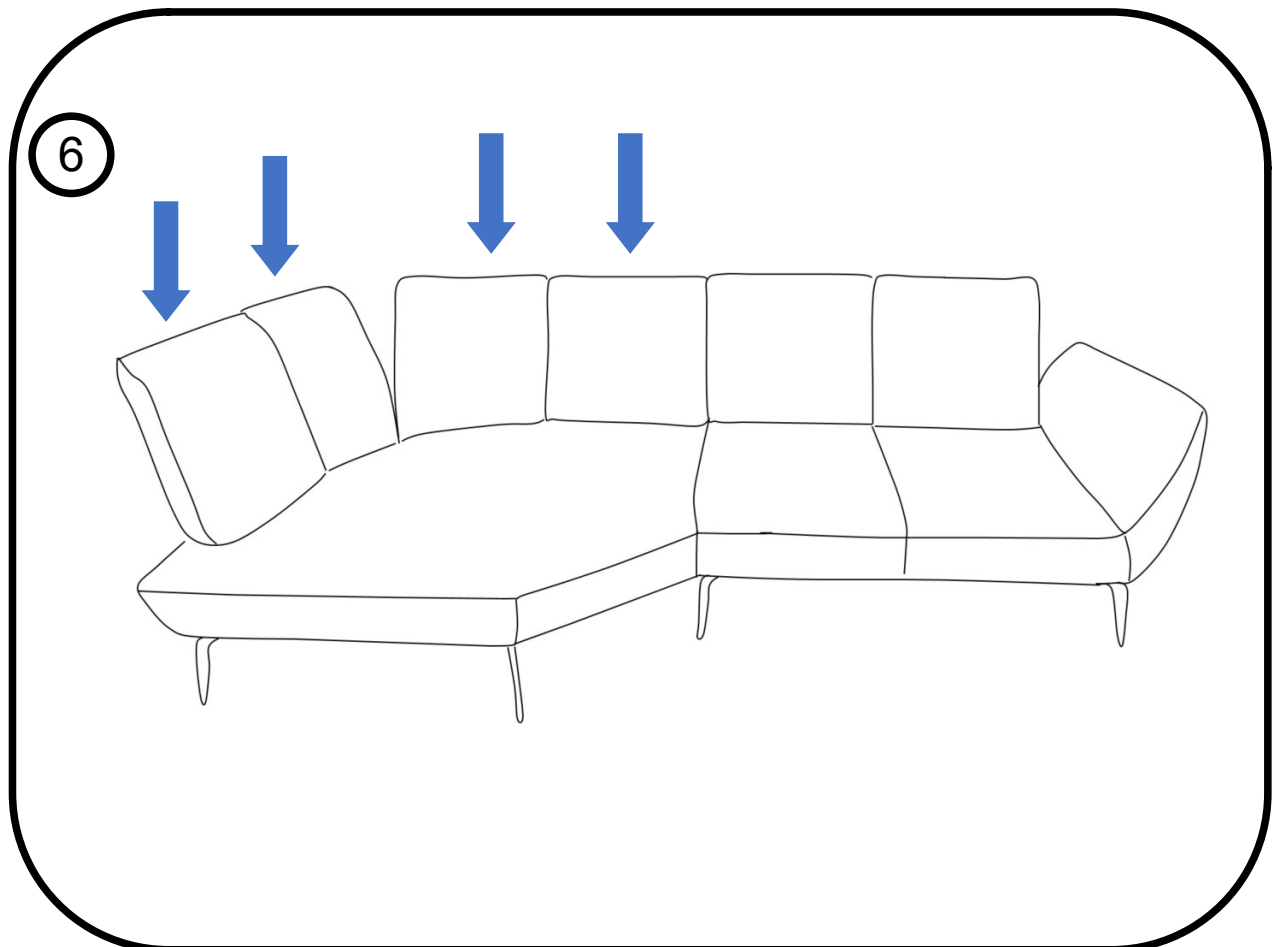
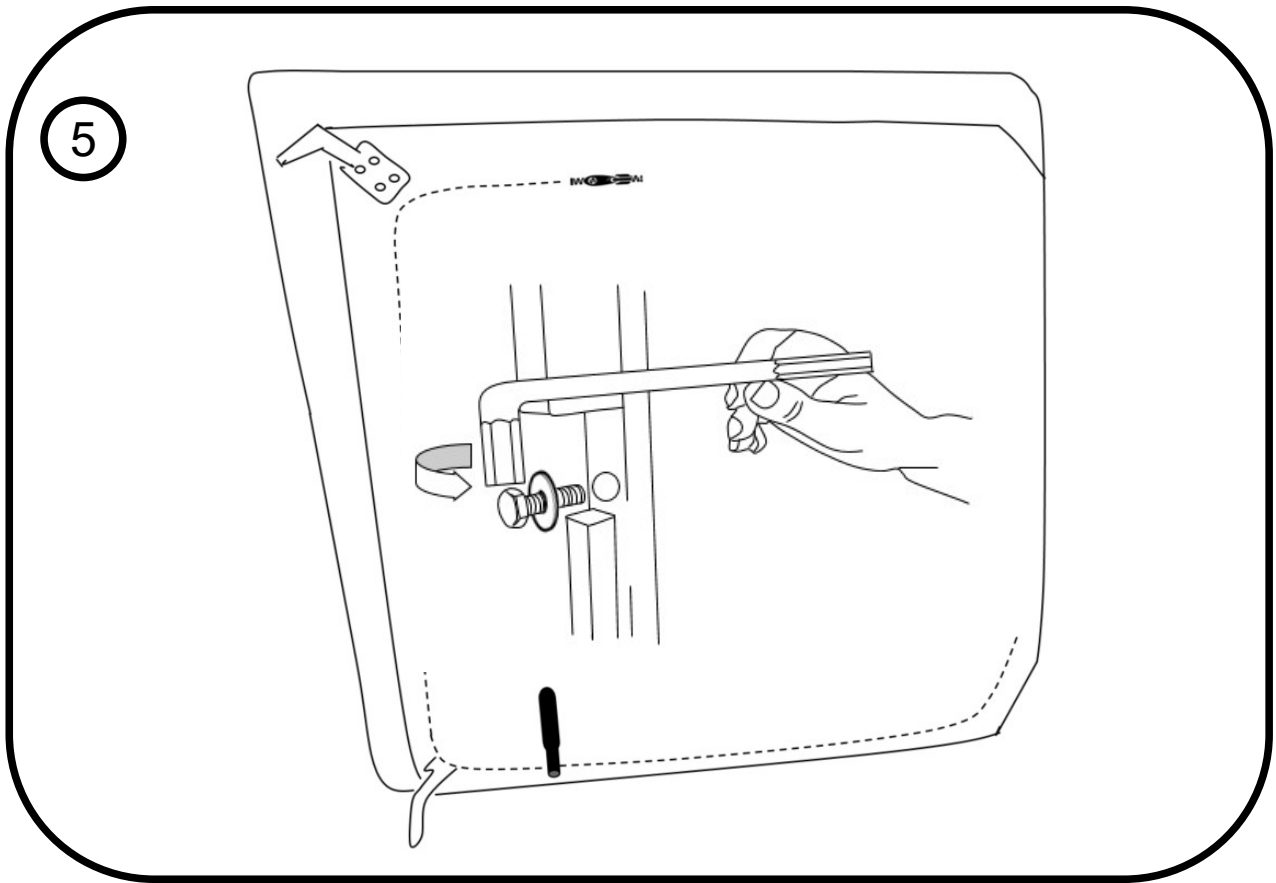

7

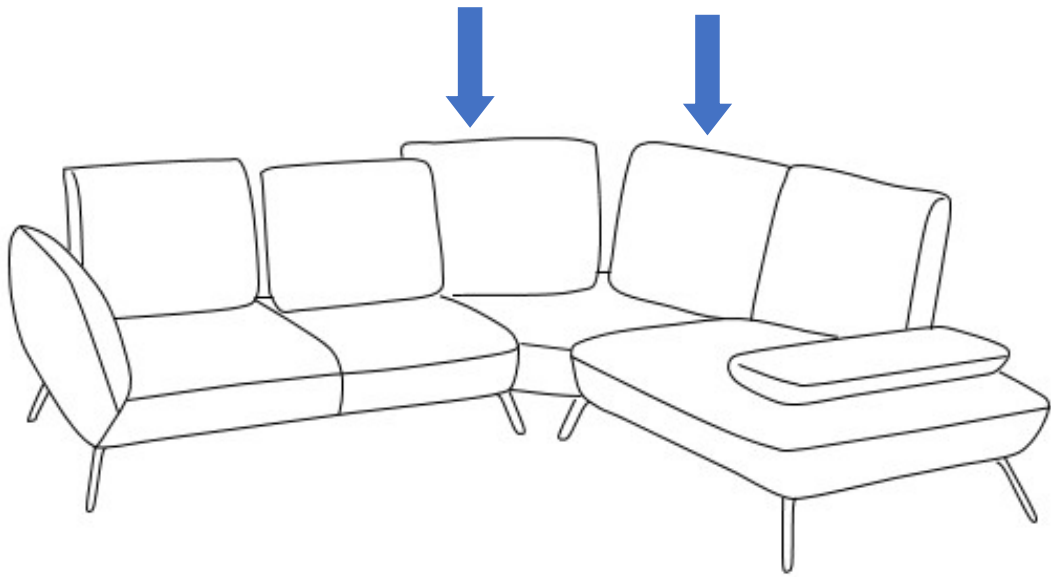

8

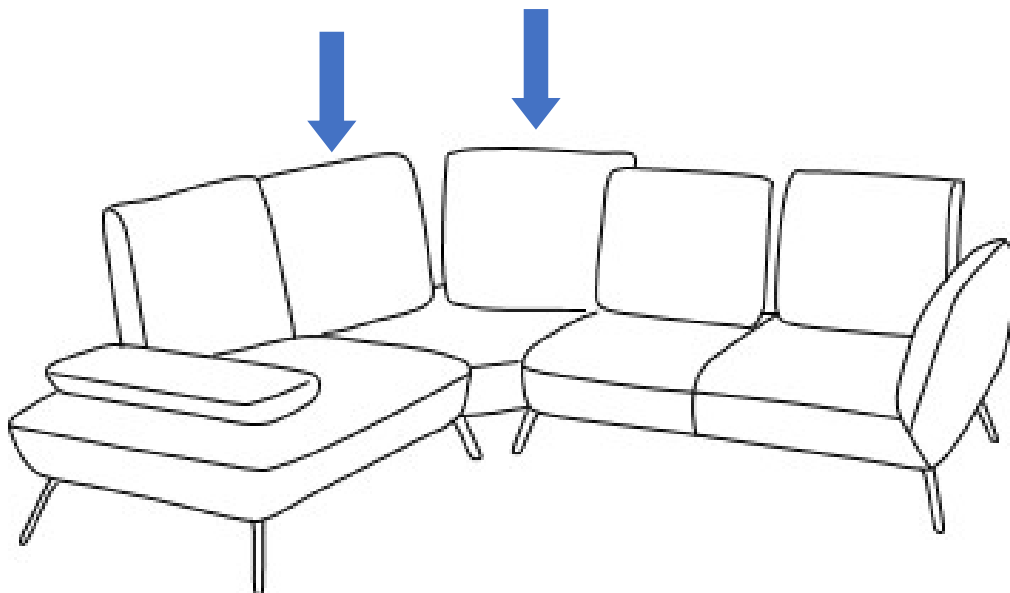

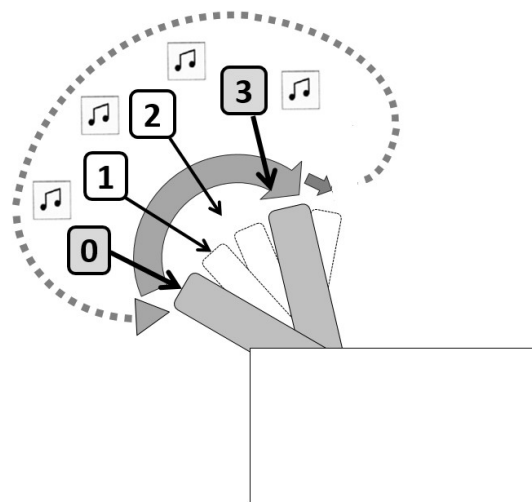
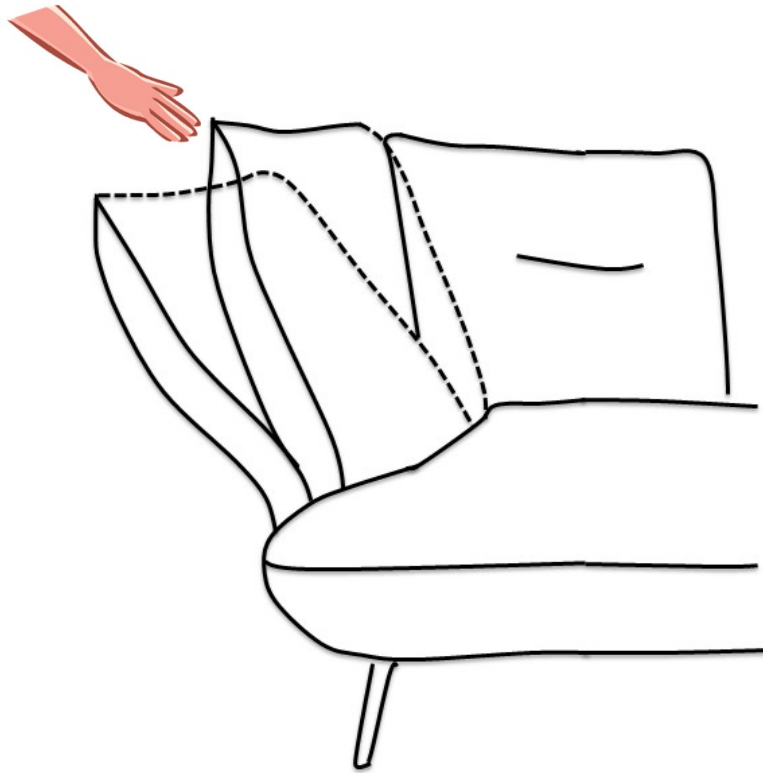
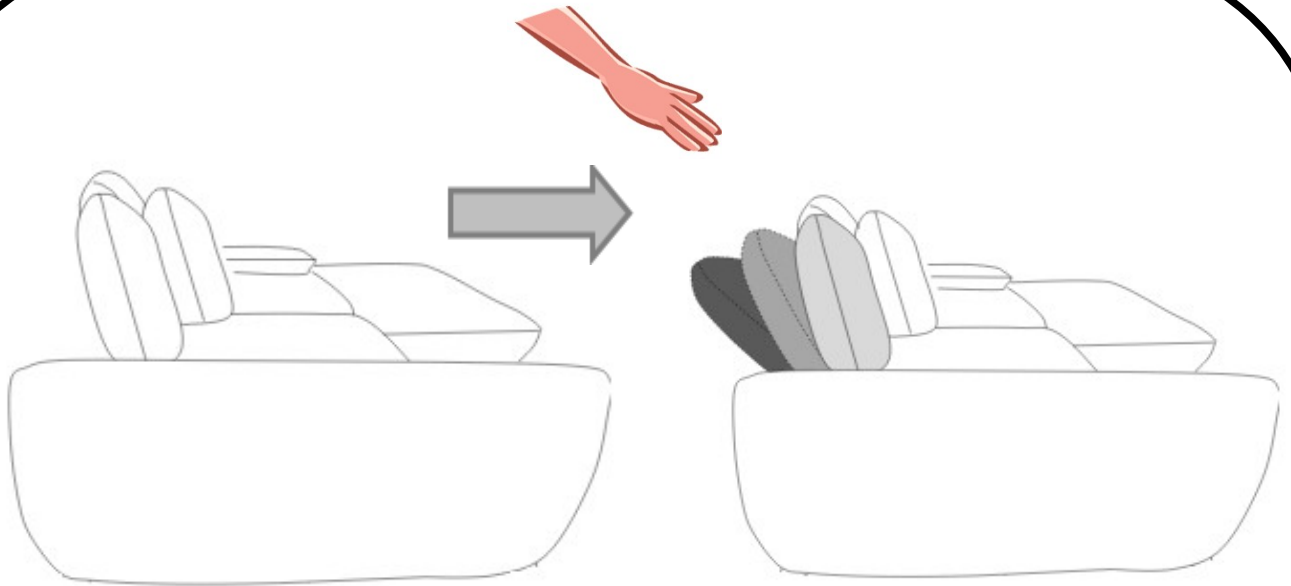

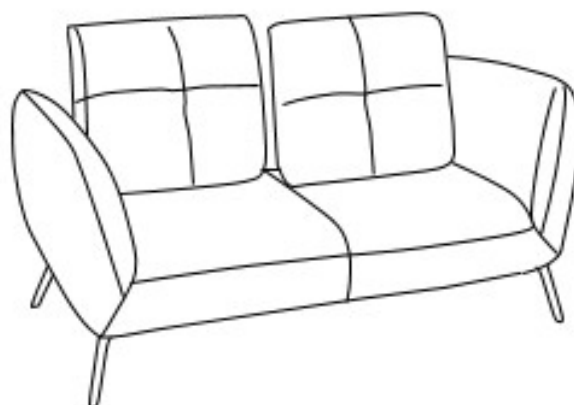
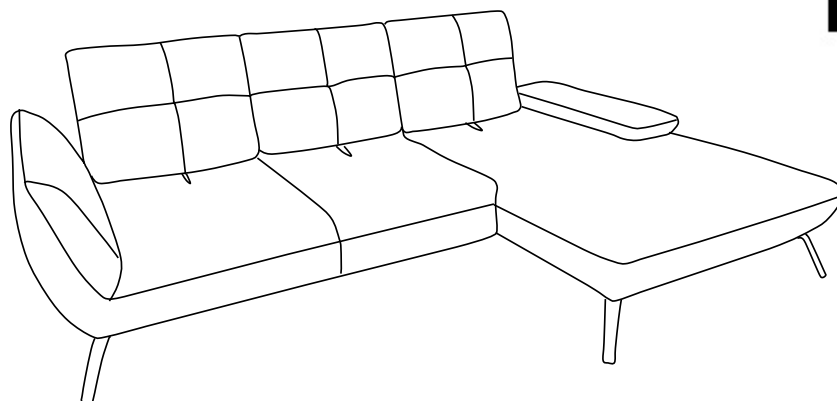
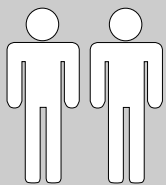

- |           |  |           |   |
|-----------|--|-----------|---|
| <b>D</b>  | MONTAGEANLEITUNG<br>BEDIENUNGSANLEITUNG                | <b>GB</b> | ASSEMBLY INSTRUCTIONS<br>INSTRUCTION MANUAL         |
| <b>NL</b> | HANDLEIDING VOOR DE MONTAGE<br>GEBRUIKSAANWIJZING      | <b>PL</b> | INSTRUKCJA MONTAŻU<br>INSTRUKCJA OBSŁUGI            |
| <b>TR</b> | MONTAJ TALIMATI<br>KULLANIM KLAVUZU                    | <b>RU</b> | ИНСТРУКЦИЯ ПО МОНТАЖУ<br>ИНСТРУКЦИЯ ПО ЭКСПЛУАТАЦИИ |
| <b>RO</b> | INSTRUCȚIUNI DE INSTALARE<br>INSTRUCȚIUNI DE UTILIZARE | <b>IT</b> | ISTRUZIONI DI MONTAGGIO<br>MANUALE DI ISTRUZIONI    |
| <b>FR</b> | NOTICE DE MONTAGE<br>MANUEL INSTRUCTIONS               | <b>SK</b> | MONTÁŽNY NÁVOD<br>NÁVOD NA POUŽITIE                 |
| <b>HU</b> | KÖZGYŰLÉS UTASÍTÁSOK<br>KEZELÉSI UTASÍTÁS              | <b>CZ</b> | MONTÁŽNÍ NÁVOD<br>NÁVOD K POUŽITÍ                   |
| <b>SI</b> | NAVODILA ZA MONTAŽO<br>NAVODILA ZA UPORABO             | <b>PT</b> | INSTRUÇÕES DE MONTAGEM<br>MANUAL DO USUÁRIO         |
| <b>ES</b> | INSTRUCCIONES DE MONTAJE<br>MANUAL DEL USUARIO         | <b>HR</b> | UPUTE ZA MONTAŽU<br>UPUTE ZA UPOTREBU               |



# Montageanleitung der Ruecken mit dem Click&Seat Beschlag

1

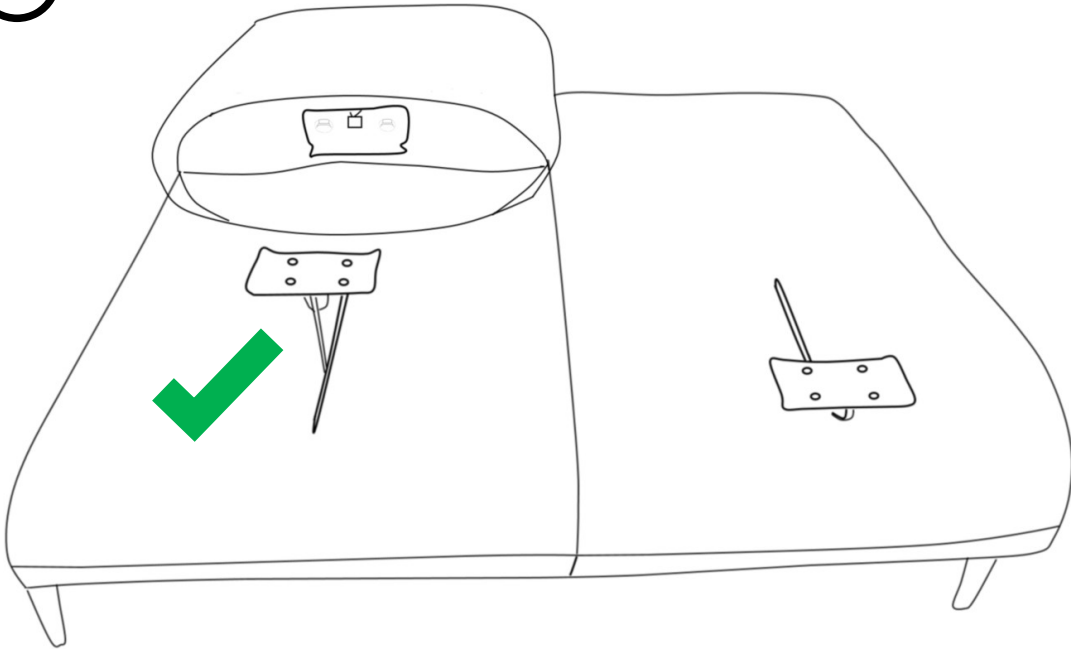

2

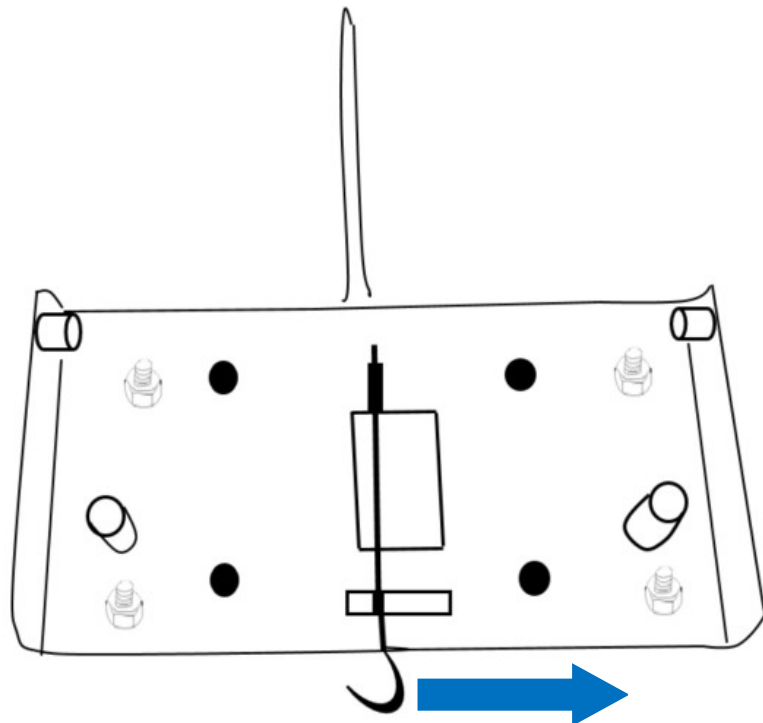

3

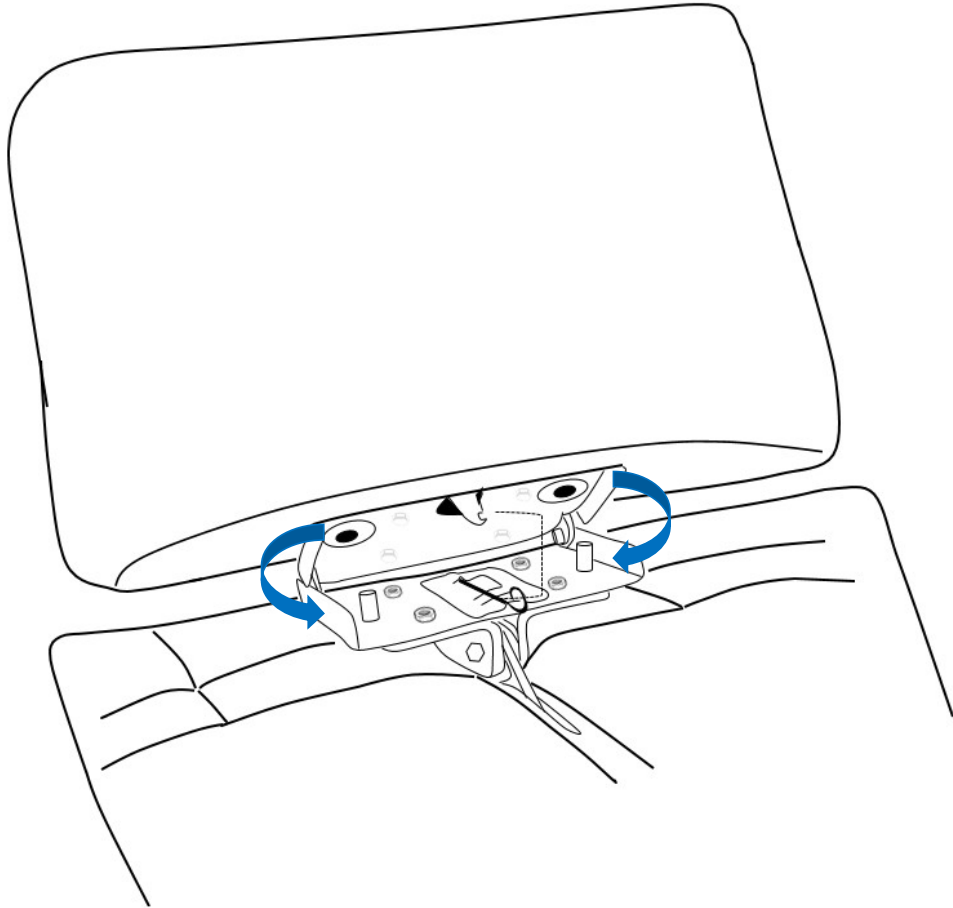

4

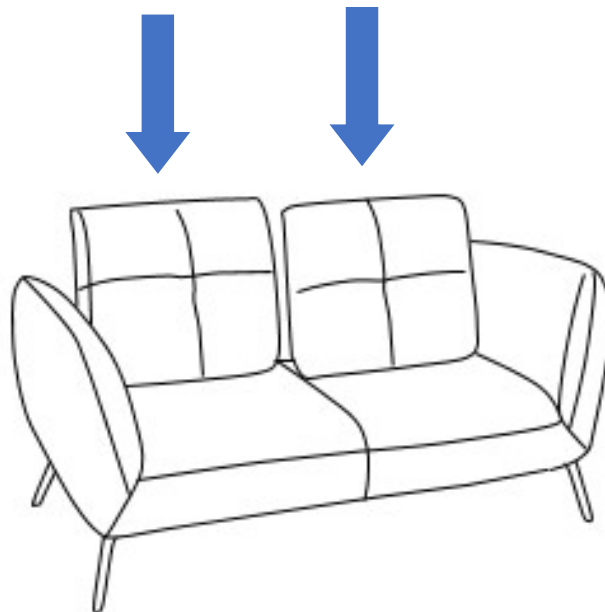

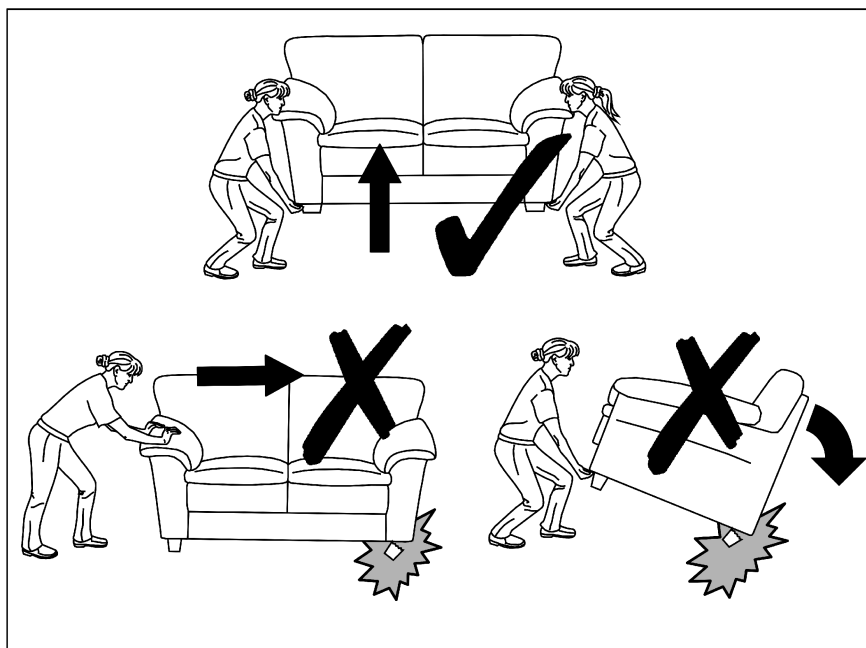
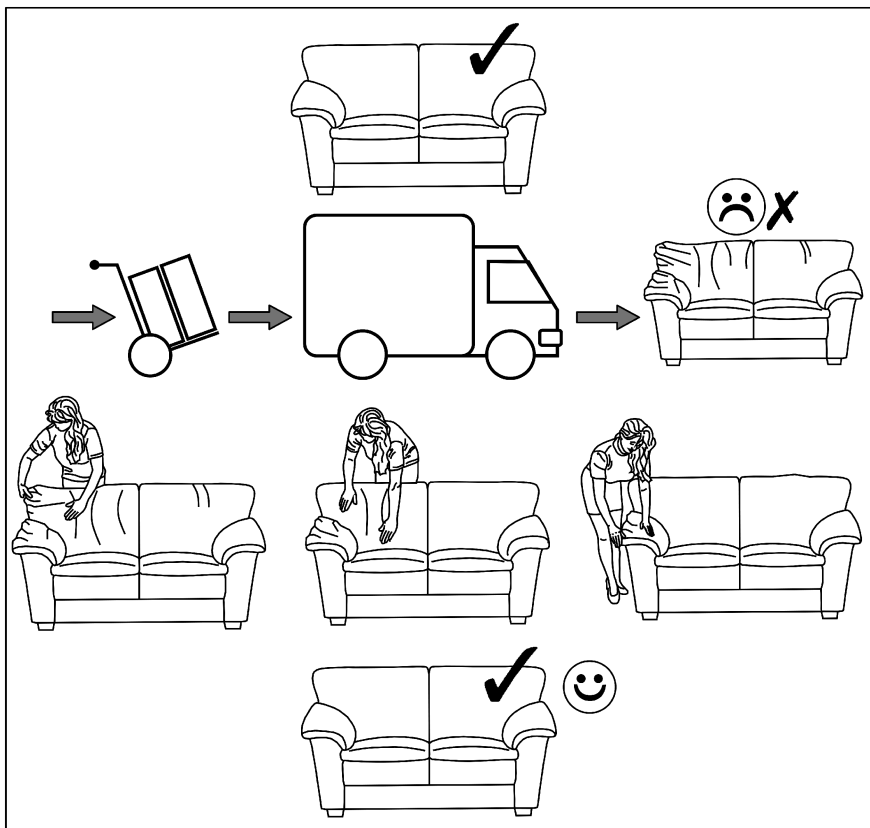
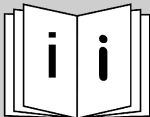

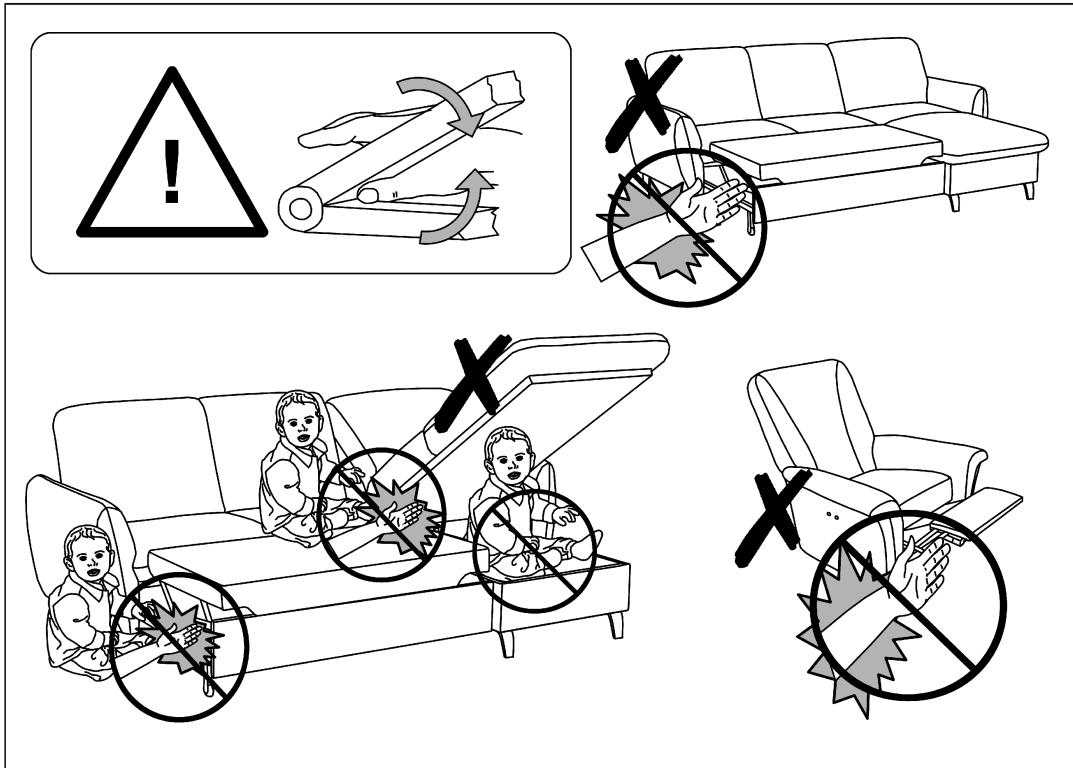
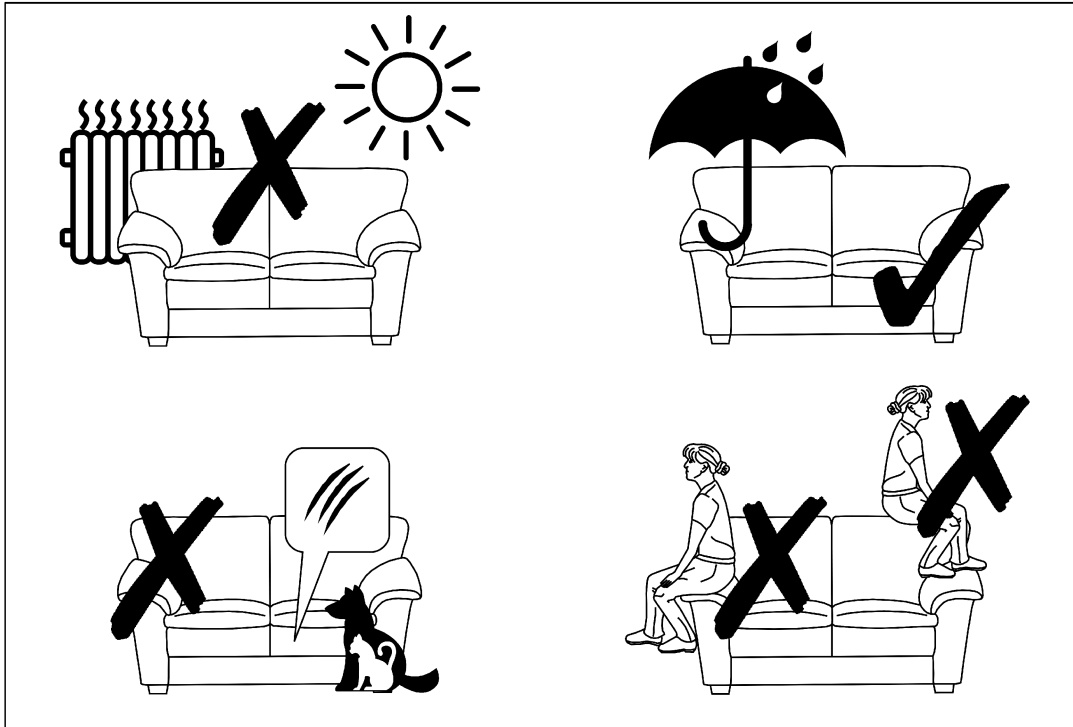

**(DE) PFLEGEHINWEISE:**

1. SORGFÄLTIG ENTSTAUBEN
2. MIT EINEM WEICHEN, SAUBEREN UND FEUCHTEM TUCH UND LEICHTER SEIFENLAUGE REINIGEN

	DEKOR PAPIER	OBERFLÄCHE LAMINAT	OBERFLÄCHE LACK	LACKIERTEN HOLZ	TEXTIL LEDER
SEIFENLAUGE (NEUTRAL SEIFE)	✓	✓	✓	✓	✓
WASSER MIT HAUSHALTREINIGER		✓	✓		
REINIGUNG NACH HERSTELLERVORGABE					✓

- BENUTZEN SIE KEINE SCHEUERMITTEL WIE PULVER, STAHLWOLLE, LÖSUNGSMITTEL
- NICHT ZU NASS ABWISCHEN

**(GB) CONSERVATION ADVICES:**

1. CAREFULLY WIPE OFF THE DUST
2. MOISTEN A SOFT, CLEAN CLOTH WITH SOAPY WATER

	VEENEER WOOD	LAMINATE SURFACE	LAMINATED WOOD SURFACE	VARNISHED SURFACE	FABRIC LEATHER
WATER WITH SOAP (GREY SOAP)	✓	✓	✓	✓	✓
WATER WITH DETERGENT		✓	✓		
MAINTENANCE PRESCRIBED BY THE MANUFACTURER					✓

- DO NOT USE ABRASIVE PRODUCTS: POWDERS, STEEL WOOL, SOLVENTS
- DO NOT OVER-WET

**(FR) CONSEILS D'ENTRETIEN:**

1. DÉPOUSSIERER SOIGNEUSEMENT
2. HUMIDIFIER UN CHIFFON DOUX ET PROPRE D'EAU SAVONNEUSE

	BOIS DE PLACAGE	SURFACES STRATIFIÉES	SURFACES LAQUÉES	BOIS VERNIS	TISSU CUIR
EAU SAVONNEUSE (SAVON NEUTRE)	✓	✓	✓	✓	✓
EAU ADDITIONNÉE DE DÉTERGENT		✓	✓		
ENTRETIEN SPÉCIFIQUE FABRICANT					✓

- NE JAMAIS UTILISER DE PRODUITS ABRASIFS: POUDRE À RÉCURER, LAINE D'ACIER, SOLVANTS
- NE PAS TROP MOUILLER

**(PL) PORADY W ZAKRESIE KONSERWACJI:**

1. ZETRZEĆ DOKŁADNIE KURZ
2. CZYSTĄ I DELIKATNĄ ŚCIERECZKĘ ZWILŻYĆ LEKKO W WODZIE Z NIEWIELKĄ ILOŚCIĄ MYDŁA

	OKLEINA	POWIERZCHNIA LAMINATU	POW. DREWNA LAKOWANEGO	POWIERZCHNIA LAKIEROWANA	TKANINA SKÓRA
WODA Z MYDŁEM (SZARE MYDŁO)	✓	✓	✓	✓	✓
WODA Z DODATKIEM ŚRODKA MYJĄCEGO		✓	✓		
KONSERWACJA ŚCIŚLE WEDŁUG ZALECEŃ PRODUCENTA					✓

- NIGDY NIE UŻYWAĆ PRODUKTÓW ŚCIERNYCH: PROSZKÓW, DRAPAKÓW, ROZPUSZCZALNIKÓW
- NIE MOCZYĆ DUŻĄ ILOŚCIĄ WODY

**(IT) CONSIGLI PER LA MANUTENZIONE:**

1. SPOLVERATE ACCURATAMENLE
2. INUMIDIRE CON ACQUA LEGGERMENTE INSAPONATA UNO STRACCIO MORBIDO PULITO

	CARTA	SUPERFICIE STRATIFICATA	SUPERFICIE LACCATE	LACCATE E LEGNO VERNICIATO	TESSILE PELLE
ACQUA CON SAPONE (SAPONE NEUTRO)	✓	✓	✓	✓	✓
ACQUA CON DETERSIVO SAN MARO		✓	✓		
MANUTENZIONE SPECIFICA PRODUTTORE					✓

- NON UTILIZZARE MAI PRODOTTI ABRASIVI: POLVERE, LANA DI ACCIAIO, SOLVENTI
- NON BAGNARE TROPPO

**(ES) CONSEJOS PARA EL MANTENIMIENTO:**

1. LIMPIAR EL POLVO CON CUIDADO
2. HUMEDECER UN PAÑO SUAVE Y LIMPIO CON AGUA LIGERAMENTE ENJABONADA

	CHAPA DE MADERA	SUPERFICIE LAMINADA	MADERA BARNIZADA	SUPERFICIE LACADA	TELA PIEL
AGUA Y JABON (JABON NEUTRO)	✓	✓	✓	✓	✓
AGUA CON DETERGENTE		✓	✓		
MANTENIMIENTO ESPECIFICO DEL FABRICANTE					✓

- NO USE NUNCA PRODUCTOS ABRASIVOS TALES COMO POLVO DE LIMPIAR, RASCADOR, DISOLVENTES
- NO MOJAR EXAGERADAMENTE

**(PT) CONSELHOS PARA A MANUTENÇÃO:**

1. LIMPE O POEIRO COM CUIDADO
2. UMEDECER UM PAÑO SUAVE E LIMPO COM AGUA E UM POUCO DE SABAO

	PLACA DE MADEIRA	SUPERFÍCIE LAMINADA	MADEIRA ENVERNIZADA	SUPERFÍCIE LACADA	TELA PELE
AGUA COM SABÃO (SABÃO NEUTRO)	✓	✓	✓	✓	✓
AGUA COM ST MARC		✓	✓		
INSTRUÇÕES ESPECÍFICAS					✓

- NUNCA UTILIZAR PRODUTOS ABRASIVOS POS, LA DE AÇO, SOLVENTES
- NAO MOLHAR DEMASIADO

**(SK) TYPY NA ÚDRŽBU:**

1. PRACH DOKŁADNE UTRITE
2. ČISTU A JEMNU HANDRIČKU NAVLHČIŤ LAHKO VO VODE Z MALÝM MNOŽSTVOM MYDLA

	TENKÁ LAMINÁTOVÁ	LAMINÁTOVÝ POVRCH	DREVENÝ POVRCH LAKOVANÝ	LAKOVANÝ POVRCH	TKANINA ČALÚDNEŇÁ
VODA Z MYDLOM	✓	✓	✓	✓	✓
VODA Z UMYVAJÚCIM PROSTRIEDKOM		✓	✓		
ÚDRŽBA IBA PODĽA POPISU VÝROBCU					✓

- NIKDY NEPOUŽÍVAŤ PROSTRIEDKY S DRSNÝM POVRCHOM : PRAŠKOV, DROBENIEK A RIEDIDIEL• NENAMÁČAJTE VEĽKÝM MNOŽSTVOM VODY

**(CZ) TYPY NA UDRŽBU:**

1. DŮKLADNĚ OTRIT PRACH
2. ČISTÝ A MĚKKÝ HADRÍK LEHCE NAVLHČIT VE VODĚ S MALÝM MNOŽSTVÍM MÝDLA

	DÝHA	LAMINÁTOVÝ POVRCH	LAKOVANÝ DŘEVĚNÝ POVRCH	LAKOVANÝ POVRCH	KOŽENÁ ČALOUNĚNÁ LÁTKA
VODA S MÝDLEM	✓	✓	✓	✓	✓
VODA S ČISTIČÍM PROSTŘEDKEM		✓	✓		
DODRŽET ÚDRŽBU POSKYTOVANOU VÝROBCEM					✓
• NEPOUŽÍVEJTE ABRASIVNÍ PROSTŘEDKY: PRASEK, ROZPOUSTĚDLA					
• NENAMACEJTE VELKÉ MNOŽSTVÍ VODY					

**(NL) ONDERHOUDSVOORSCHRIFT:**

1. ZORGVULDIG STOFVRIJ MAKEN
2. MET EEN ZACHTE SCHONE EN VOCHTIGE DOEK MET NEUTRALE ZEEP REINIGEN

	FOLIE	TOPLAAG LAMINAAT	TOPLAAG LAK	GELAKT HOUT	TEXTIEL LEER
NEUTRALE ZEEP	✓	✓	✓	✓	✓
WATER MET HUISHOUD REINIGINGSMIDDEL		✓	✓		
DOOR DE PRODUCENT GESPECIFICEERD ONDERHOUD					✓
• GEBRUIKT U GEËN SCHUURMIDDELEN ZOALS SCHUURPOEDER, STAALWOL, OPLOSMIDDEL					
• NIET TE NAT AFNEMEN					

**(HU) KARBANTARTÁSI TANÁCSOK:**

1. ALAPOSAN LETÖRÖLNI A PORT
2. EGY TISZTA ÉS LÁGY TÖRLŐKENDŐT BENEDVESÍTENI ENYHÉN SZAPPANOS VÍZZEL

	FURNÉR	LAMINÁLT FELÜLET	LAKKOZOTT FAFELÜLET	LAKKOZOTT FELÜLET	BŐRKÁRPIT
SZAPPANOS VÍZ (MOSÓSZAPPAN)	✓	✓	✓	✓	✓
MOSÓSZERES VÍZ		✓	✓		
KARBANTARTÁS SZIGORÚAN A GYÁRTÓ UTASÍTÁSAI SZERINT					✓
• SOHA NE HASZNÁLJON SÚROLO HATASU TISZTÍTÓSZERT: PORT, KAPAROT, OLDOSZERT					
• NE ZATASSA BO VÍZZEL					

**(RO) SFATURI PENTRU ÎNTREȚINERE:**

1. ȘTERGEȚI BINE PRAFUL
2. UMEZIȚI UȘOR O LAVETĂ USCATĂ ȘI DELICATĂ ÎN APĂ CU PUȚIN SĂPUN

	FURNIR	SUPRAFAȚĂ LAMINAT	SUPRAFAȚĂ LEMN LĂCUIȚ	SUPRAFAȚĂ LĂCUIȚĂ	ȚESĂTURĂ CĂPTUȘEALĂ PIELE
APĂ CU SĂPUN	✓	✓	✓	✓	✓
APĂ CU DETERGENT		✓	✓		
ÎNȚEȚINEȚI ÎN CONFORMITATE STRICTĂ CU RECOMANDĂRILE PRODUCĂTORULUI					✓
• NU FOLOSIȚI NICIODATĂ PRODUSE ABRASIVE: DETERGENȚI PRF, ZGĂRIETOARE, DILUANȚI					
• NU SPĂLAȚI CU O CANTITATE MARE DE APĂ					

**(RU) РЕКОМЕНДАЦИИ ПО УХОДУ:**

1. ТЩАТЕЛЬНО ВЫТЕРЕТЬ ПЫЛЬ
2. ЧИСТУЮ И МЯГКУЮ ТРЯПОЧКУ СЛЕГКА УВЛАЖНИТЬ В ВОДЕ С НЕБОЛЬШИМ КОЛИЧЕСТВОМ МЫЛА

	ОБЛИЦОВКА	ЛАМИНИРУЮЩА Я ПЛЁНКА	ПОВЕРХНОСТЬ ЛАКИРОВАННОЙ ДРЕВЕСИНЫ	ЛАКИРОВАННАЯ ПОВЕРХНОСТЬ	ОБИЧОВНАЯ ТКАНЬ, КОЖА
ВОДА С МЫЛОМ (ХОЗЯЙСТВЕННОЕ МЫЛО)	✓	✓	✓	✓	✓
ВОДА С ДОБАВКОЙ МОУЩЕГО СРЕДСТВА		✓	✓		
УХОД СТРОГО ПО УКАЗАНИЯМ ПРОИЗВОДИТЕЛЯ					✓
• НИ В КОЕМ СЛУЧАЕ НЕ ИСПОЛЬЗОВАТЬ АБРАЗИВНЫХ ИЗДЕЛИЙ: ПОРОШКОВ, ЦАРАПОК, РАСТВОРИТЕЛЕЙ					
• НЕ СМАЧИВАТЬ БОЛЬШИМ КОЛИЧЕСТВОМ ВОДЫ					

**(TU) BAKIM TALÍMATLARI:**

1. TOZUNU DIKKATLICE ALINIZ
2. YUMUŞAK VE TEMİZ BİR BEZİ SABUNLU SU İLE ISLATINIZ

	KAPLAMA	LAMINAT YÜZEY	LAKE AHŞAP YÜZEY	LAKE YÜZEY	DÖŞEMELİK KUMAŞ, DERİ
SABUNLU SU (NORMAL SABUN)	✓	✓	✓	✓	✓
DETERJANLI SU		✓	✓		
ÜRETİCİNİN BAKIM VE YIKAMA TALÍMATLARI					✓
• TOZ, TEL, SOLVENT GIBI AŞINDIRICI URUNLERİ KULLANMAYINIZ					
• BOL SU İLE ISLATMAYINIZ					

**(SI) NASVETI ZA VZDRŽEVANJE:**

1. SKRBNO OBRISITE PRAH
2. ČISTO IN MEHKO KRPO RAHLO NAVLAŽITE V VODI Z MAJHNO KOLIČINO MILA

	FURNIR	POVRŠINA LAMINATA	POVRŠINA LES LAK	LAKIRANA POVRŠINA	OBLAZINJENJE USNJE
VODA IN MILO (MEHKO MILO)	✓	✓	✓	✓	✓
VODA Z DODATKOM DETERGENTA		✓	✓		
VZDRŽEVATI DOSLEDNO V SKLADU Z NAVODILI PROIZVAJALCA					✓
• NIKOLI NE UPORABUJATE ABRASIVNIH SREDSTEV: PRAŠKOV, GOBIC IZ ŽICE, TOPIL					
• NE NAMAKAJTE Z VELIKO KOLIČINO VODE					

**(HR) UPUTE ZA ODRŽAVANJE:**

1. PAŽLJIVO OBRISATI PRAŠINU
2. PREBRISATI ČISTOM, MEKOM TKANINOM NAVLAŽENOJ U BLAGOJ OTOPINI SAPUNA ILI DETERDŽENTA

	PAPIR	LAMINAT	LAK	DRVO	TEKSTIL KOŽA
OTPINA SAPUNA	✓	✓	✓	✓	✓
OTPINA DETERDŽENTA		✓	✓		
NAMIJENSKA SREDSTVA					✓
• ZABRANJENA JE UPOTREBA KEMIKAJIJA ILI BILO KAKVIH POMOĆNIH SREDSTAVA ZA RIBANJE JAKIH DSREDSTAVA ZA ČIŠĆENJE ILI ČELIČNE VUNE					
• ZABRANJENO JE ČIŠĆENJE SA PREVIŠE VODE/VLAGE					

Herstellerkennzeichnung:

Hergestellt für VITO durch

SCS Sp. z o.o.

Ul. Fabryczna 13

69-110 Rzepin

Polen

[poco@steinpol.com.pl](mailto:poco@steinpol.com.pl)