

TV Sesselin
1222
2016-05/2

- | | | | |
|-----------|-----------------------------|-----------|-------------------------|
| D | MONTAGEANLEITUNG | GB | INSTRUCTION MANUAL |
| NL | HANDLEIDING VOOR DE MONTAGE | PL | INSTRUKCJA MONTAŻU |
| TR | MONTAJ TALIMATI | RU | ИНСТРУКЦИЯ ПО МОНТАЖУ |
| RO | INSTRUCȚIUNI DE INSTALARE | IT | ISTRUZIONI DI MONTAGGIO |
| FR | NOTICE DE MONTAGE | SK | MONTÁŽNY NÁVOD |
| HU | KÖZGYŰLÉS UTASÍTÁSOK | CZ | MONTÁŽNÍ NÁVOD |
| SI | NAVODILA ZA MONTAŽO | PT | INSTRUÇÕES DE MONTAGEM |
| ES | INSTRUCCIONES DE MONTAJE | HR | UPUTE ZA MONTAŽU |

Service · Dienstverlening · Serwis · Servis · Сервисная служба · Serviciu · Services · Servizio
· Servisný list · Szolgáltatás · Servisní list

Name · Naam · Nazwa · İsim · Название · Nume · Nome · Názov · Názov ·
Název · Neve

Typ · Type · Tip · Тип · Tipo · Típus

1222

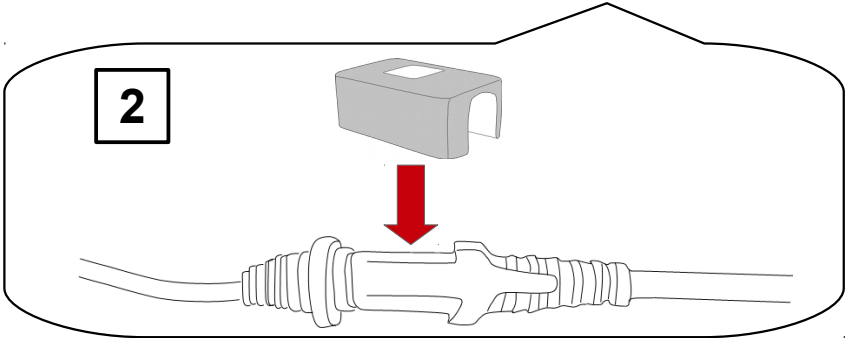
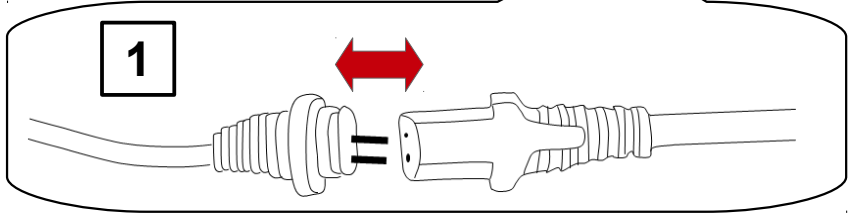
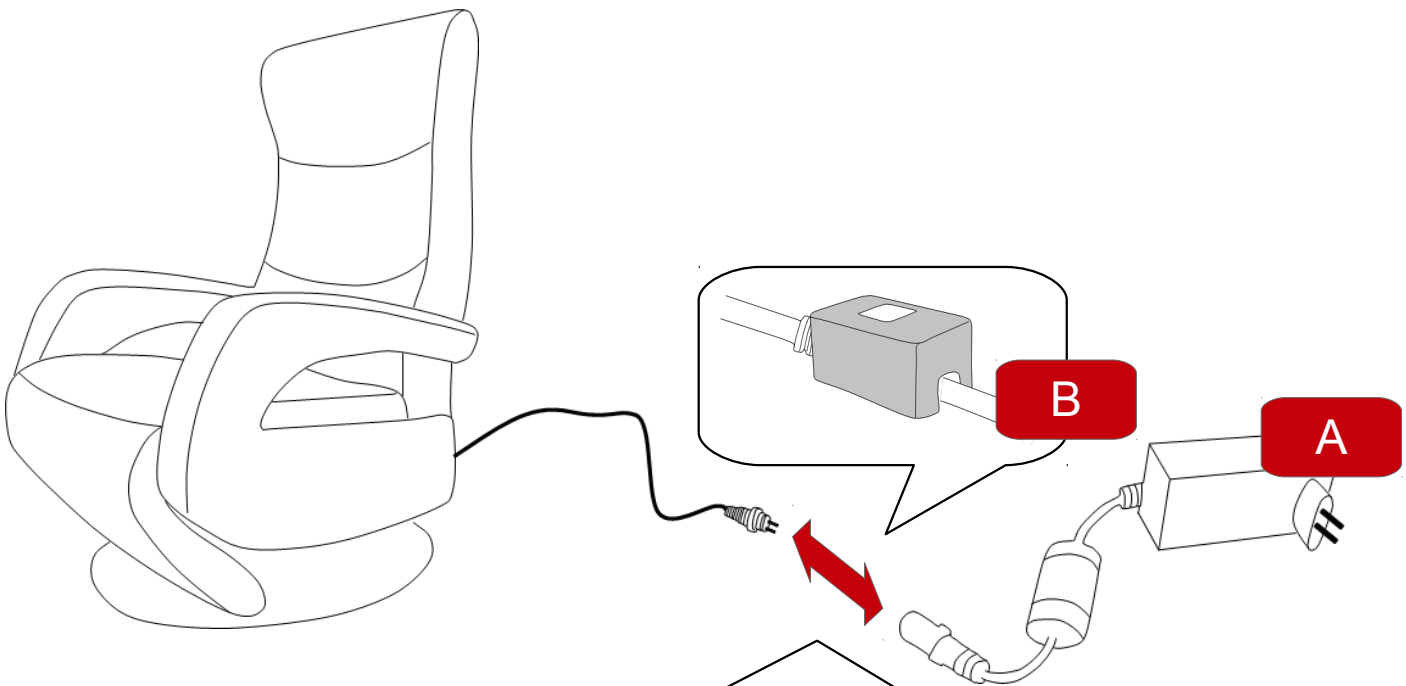
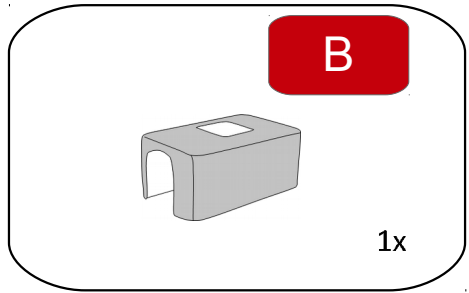
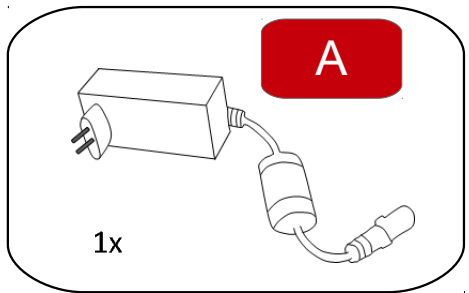
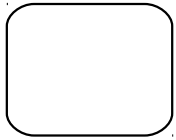
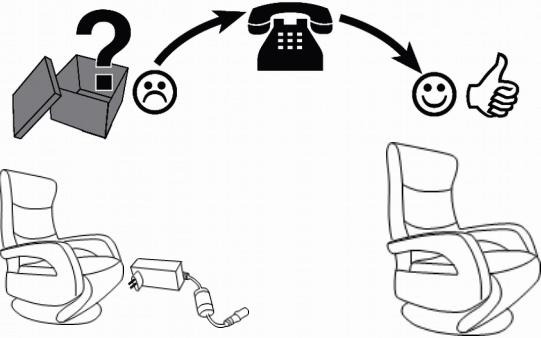
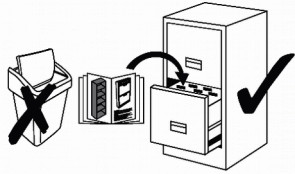

Service · Dienstverlening · Serwis · Servis · Сервисная служба · Serviciu · Services · Servizio
 ·Servisný list · Szolgáltatás · Servisní list

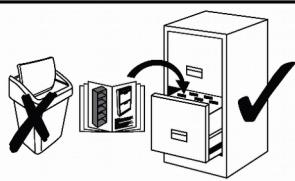
Name · Naam · Nazwa · Isim · Название · Nume · Nome · Názov · Názov · Název · Neve
Typ · Type · Tip · Тип · Тиро · Típus
☎ 1222

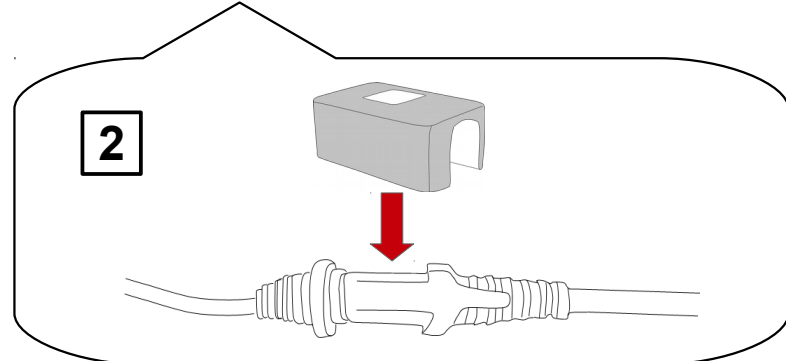
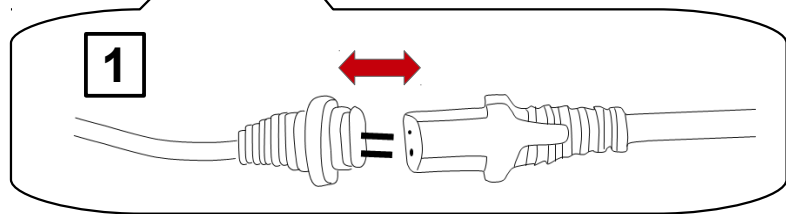
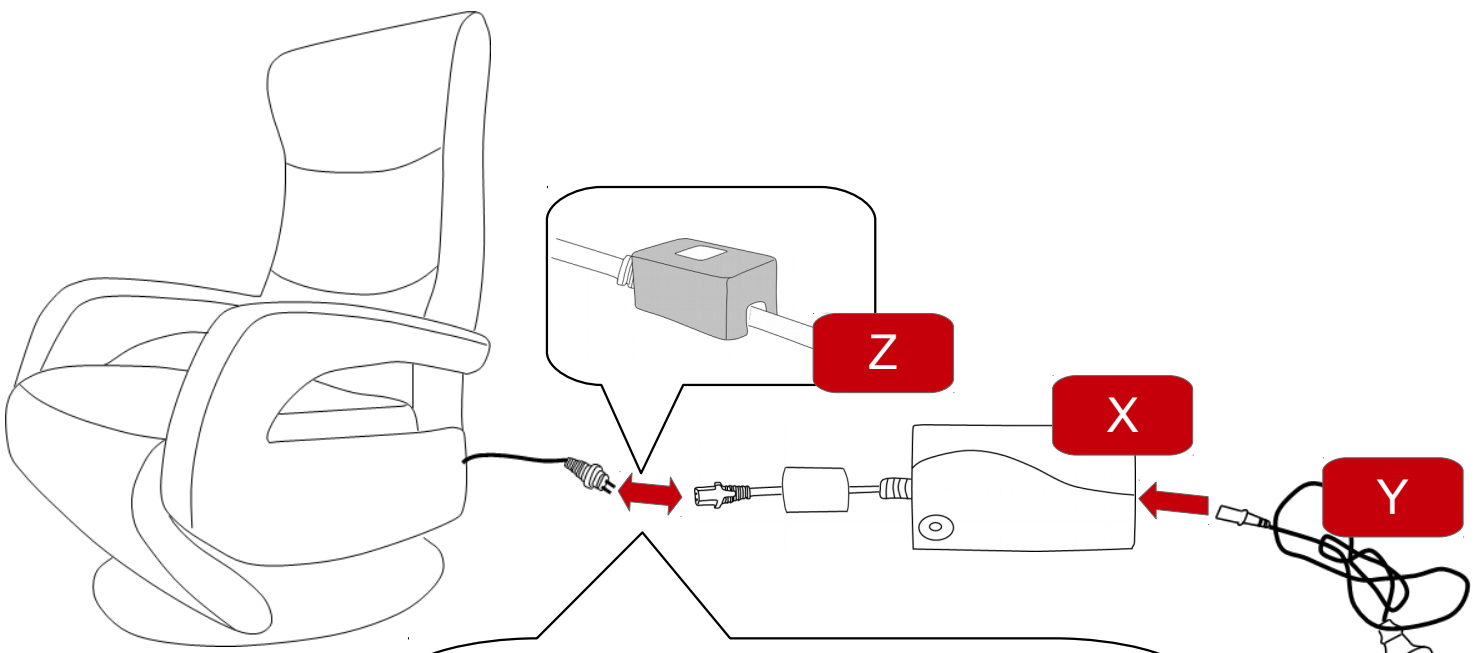
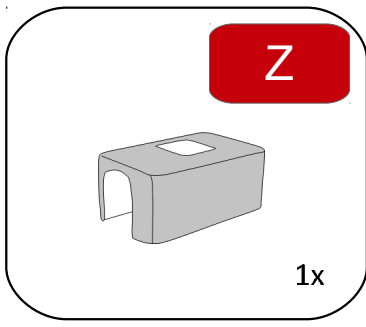
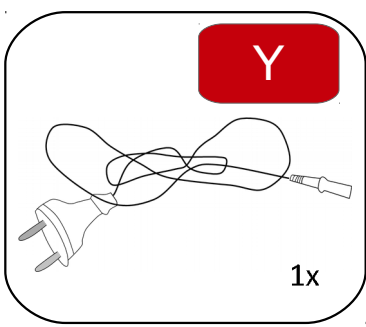
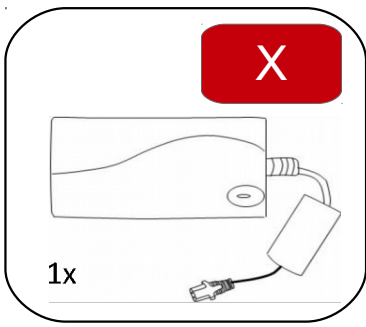
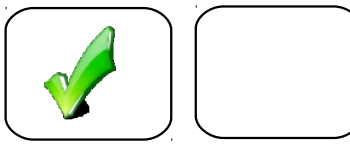
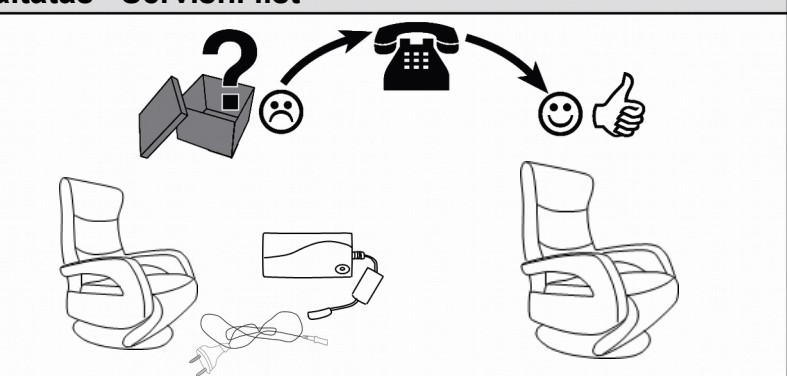

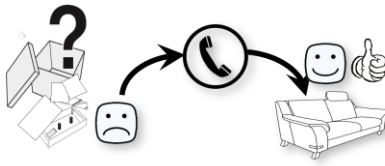

KT - Verstellung

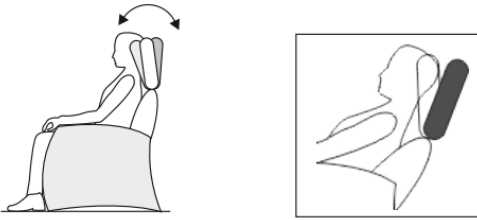

KT – Verstellung motorisch

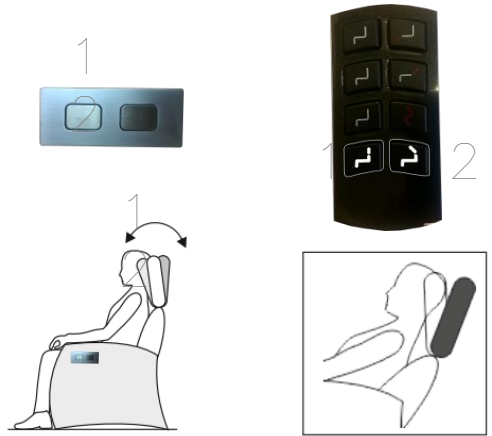

Manuell

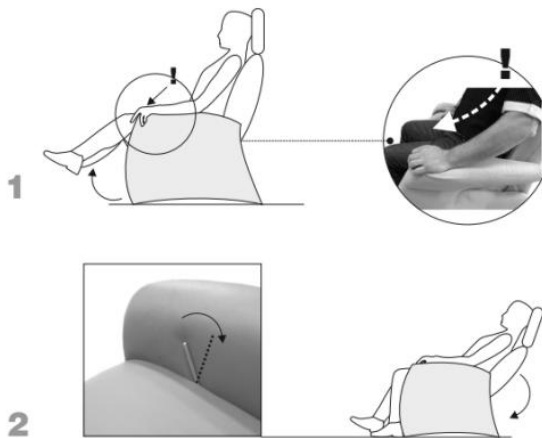

Manuell + mitlaufendes Armteil

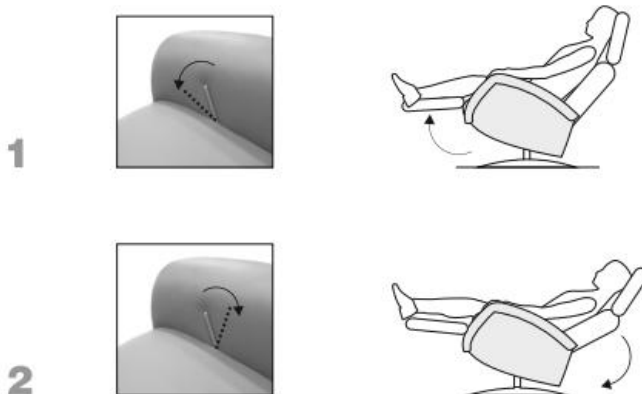

D1K0036

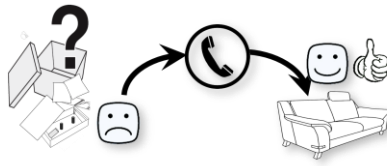

2 - motorisch

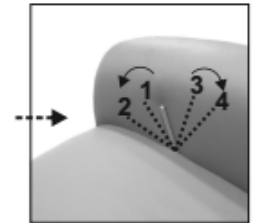
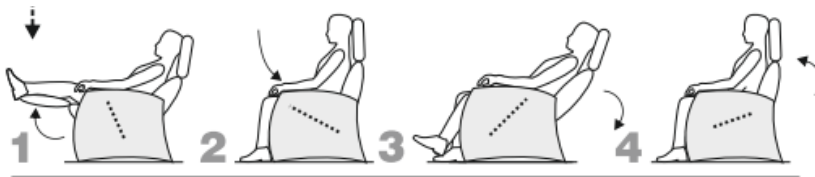
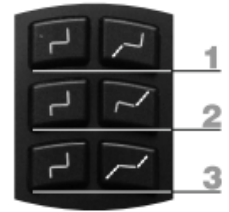

2 – motorisch Aufstehhilfe

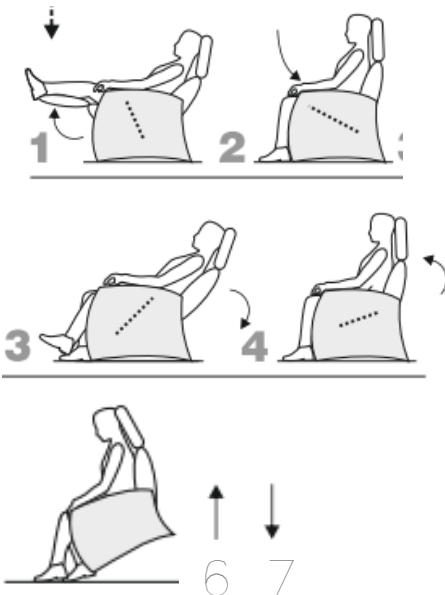

D1K0036

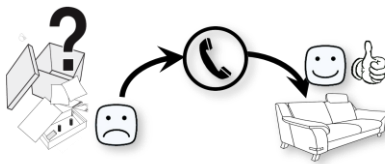

Herz Waage

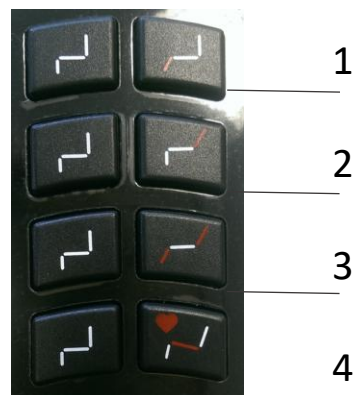
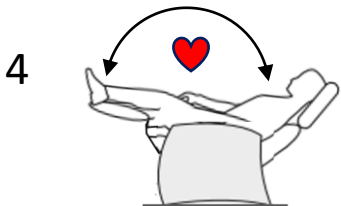
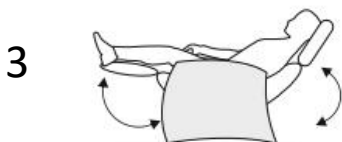
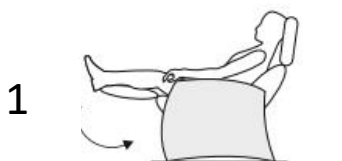

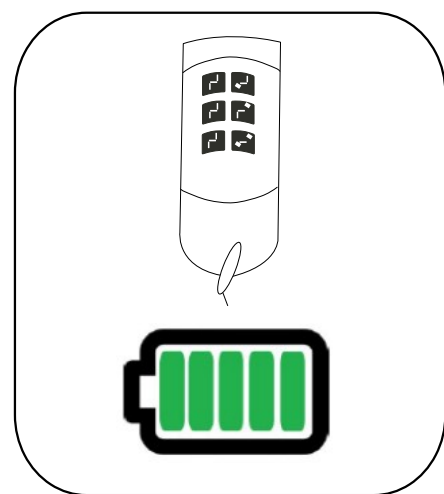
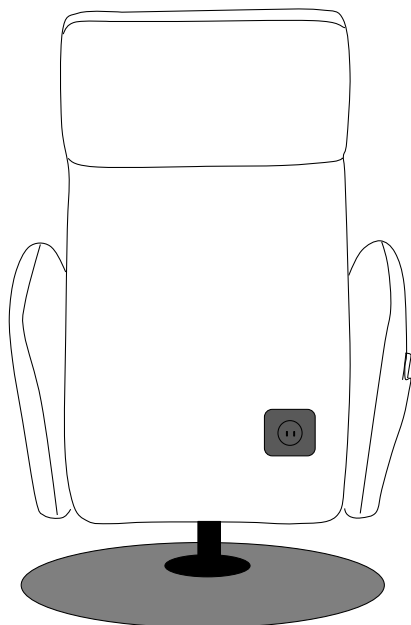
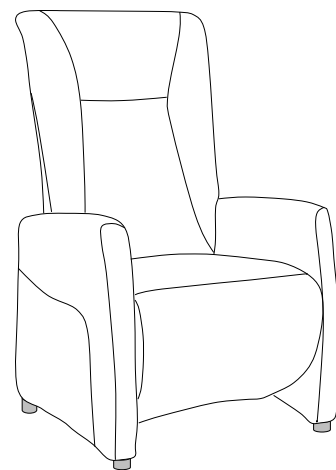
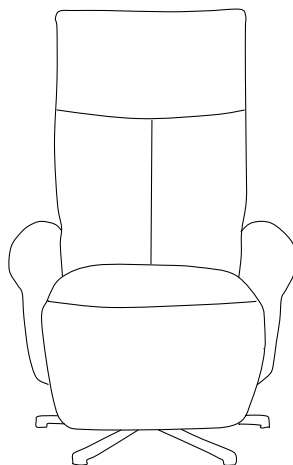
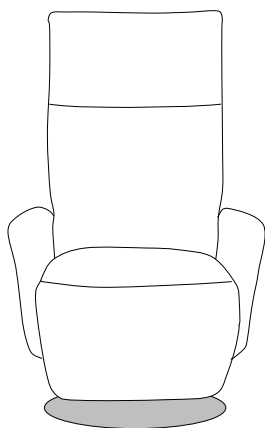
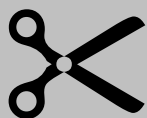
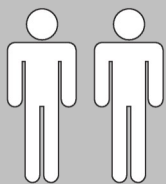

TV Sesselin
1222 / 1230
2023.02.21/02

D MONTAGEANLEITUNG
BEDIENUNGSANLEITUNG

NL HANDLEIDING VOOR DE MONTAGE
GEBRUIKSAANWIJZING

TR MONTAJ TALIMATI
KULLANIM KLAVUZU

RO INSTRUCȚIUNI DE INSTALARE
INSTRUCȚIUNI DE UTILIZARE

FR NOTICE DE MONTAGE
MANUEL D'INSTRUCTION

HU KÖZGYŰLÉS UTASÍTÁSOK
KEZELÉSI UTASÍTÁS

SI NAVODILA ZA MONTAŽO
NAVODILA ZA UPORABO

ES INSTRUCCIONES DE MONTAJE
MANUAL DEL USUARIO

GB ASSEMBLY INSTRUCTIONS
INSTRUCTION MANUAL

PL INSTRUKCJA MONTAŻU
INSTRUKCJA OBSŁUGI

RU ИНСТРУКЦИЯ ПО МОНТАЖУ
ИНСТРУКЦИЯ ПО ЭКСПЛУАТАЦИИ

IT ISTRUZIONI DI MONTAGGIO
MANUALE DI ISTRUZIONI

SK MONTÁŽNY NÁVOD
NÁVOD NA POUŽITIE

CZ MONTÁŽNÍ NÁVOD
NÁVOD K POUŽITÍ

PT INSTRUÇÕES DE MONTAGEM
MANUAL DO USUÁRIO

HR UPUTE ZA MONTAŽU
UPUTE ZA UPOTREBU

Name · Naam · Nazwa · Ísim · Название · Nume · Nome · Názov · Názov ·
Název · Neve

Typ · Type · Tip · Тип · Típo · Típus

1222 / 1230

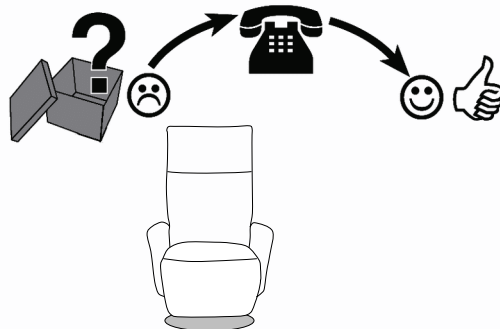
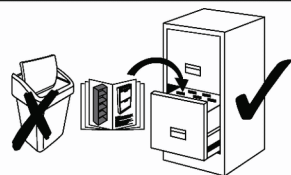

1x

A

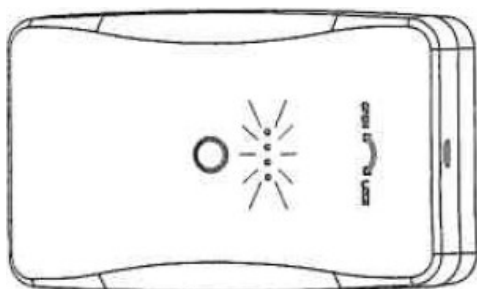

1x

B

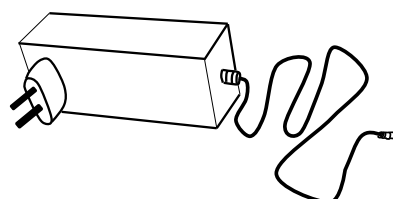

Input: 100-240V~, 50/60Hz, 0,35A
Output: 5,0V= 2,0A

D Befolgen Sie stets die Anleitungen des Herstellers / GB Always follow the instructions of the manufacturer / FR Suivez toujours les instructions du fabricant / IT Seguire sempre le istruzioni del produttore / NL Volg steeds de instructies van de fabrikant / PL Zawsze należy przestrzegać instrukcji producenta / CZ Vždy se řiďte pokyny výrobce / SK Vždy dodržiavajte pokyny výrobcu / HU Kövesse a gyártó utasításait / RO Urmați instrucțiunile producătorului / TR Daima üreticinin talimatlarına uyunuz / RU Строго соблюдайте инструкции производителя.

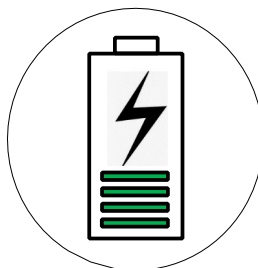

ACHTUNG / ATTENTION !!!

LADEN SIE DEN AKKU VOR DEM ERSTEN GEBRAUCH VOLLSTÄNDIG AUF.

CHARGER COMPLÈTEMENT LE BLOC-BATTERIE AVANT SA PREMIÈRE UTILISATION.

CHARGE BATTERY PACK BEFORE FIRST USE ONCE COMPLETELY.

A

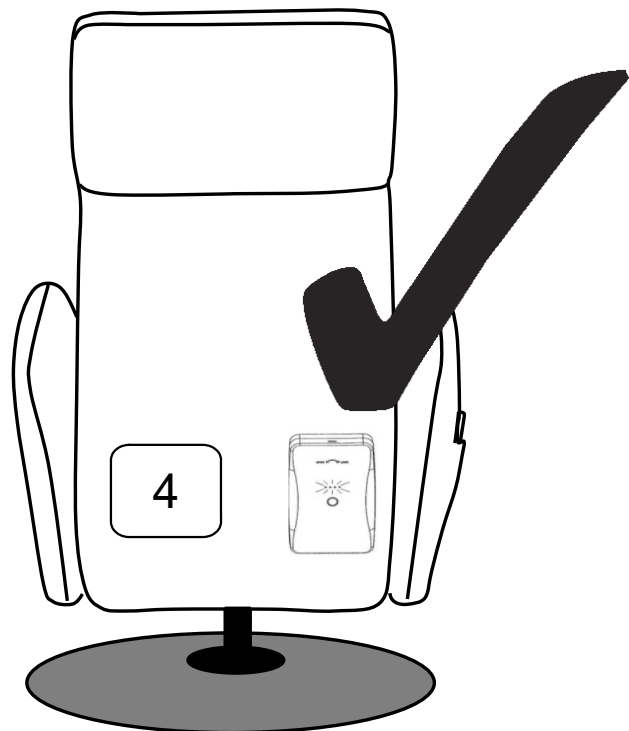
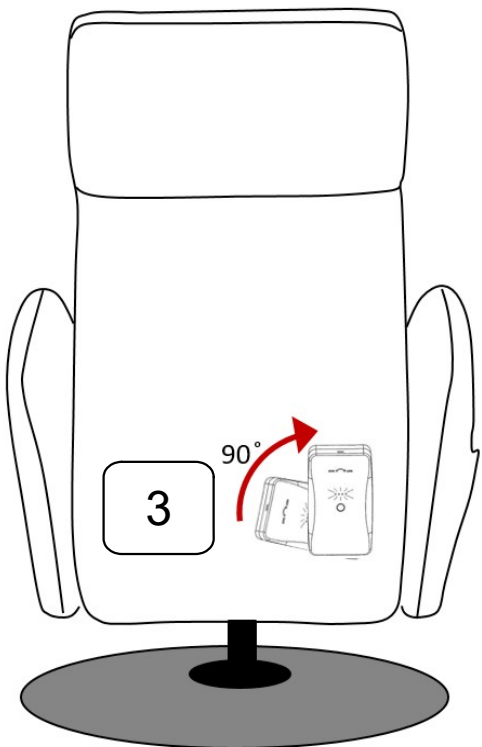
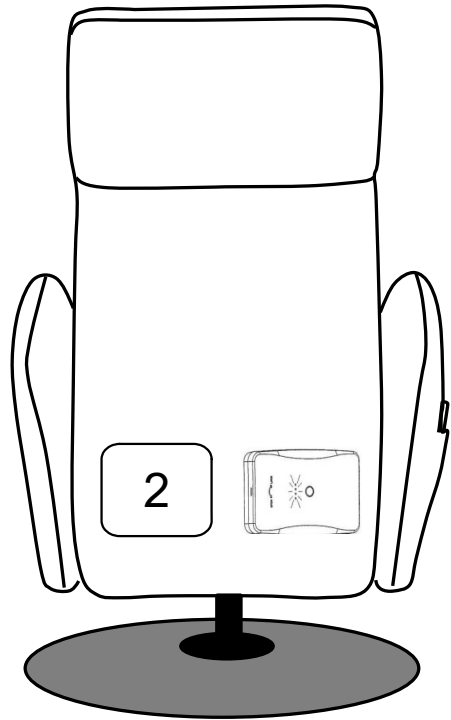
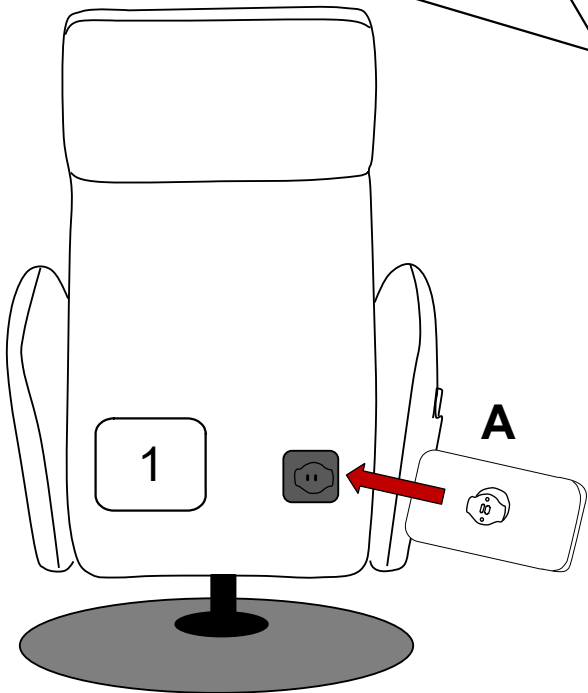
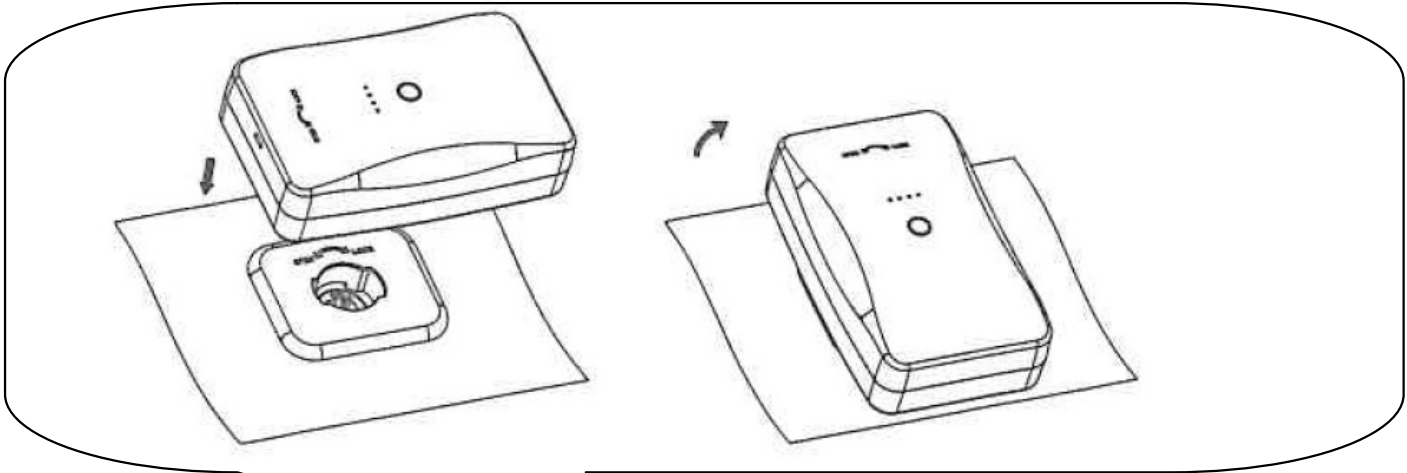

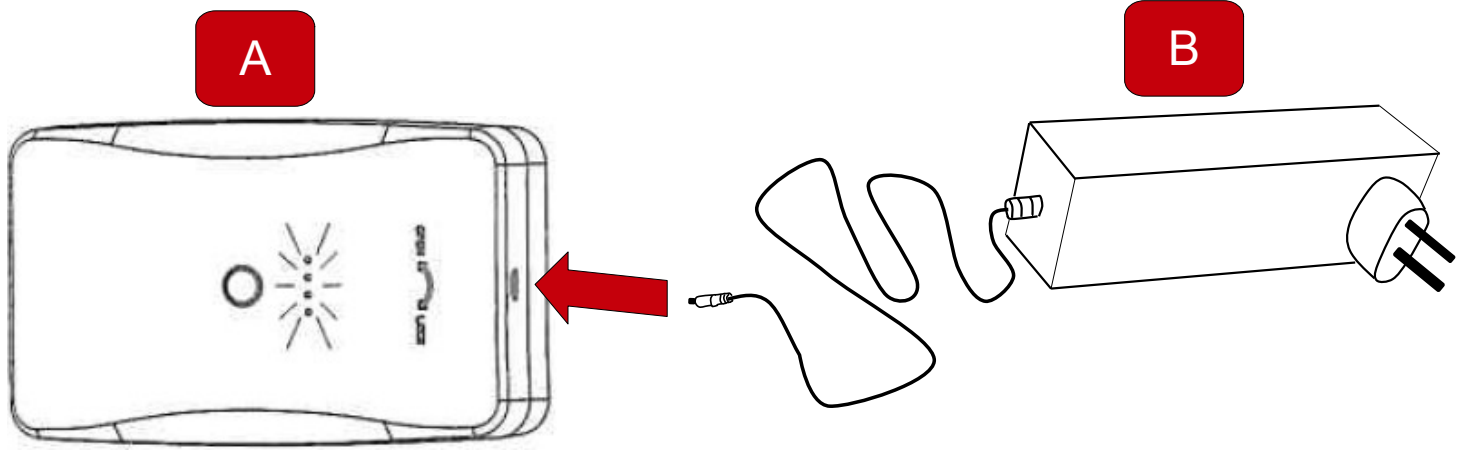
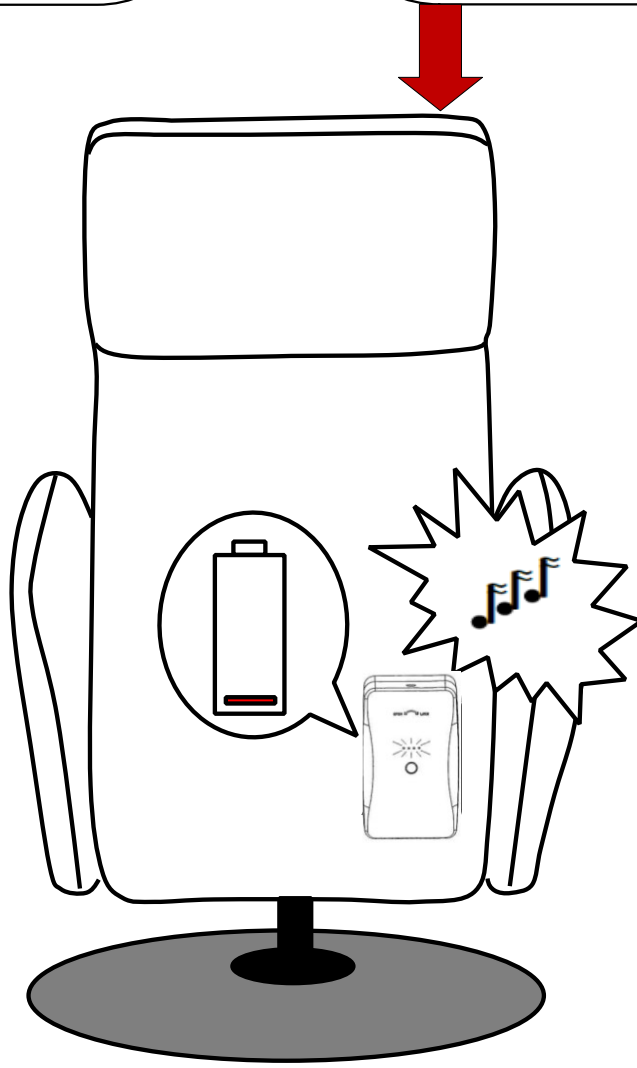
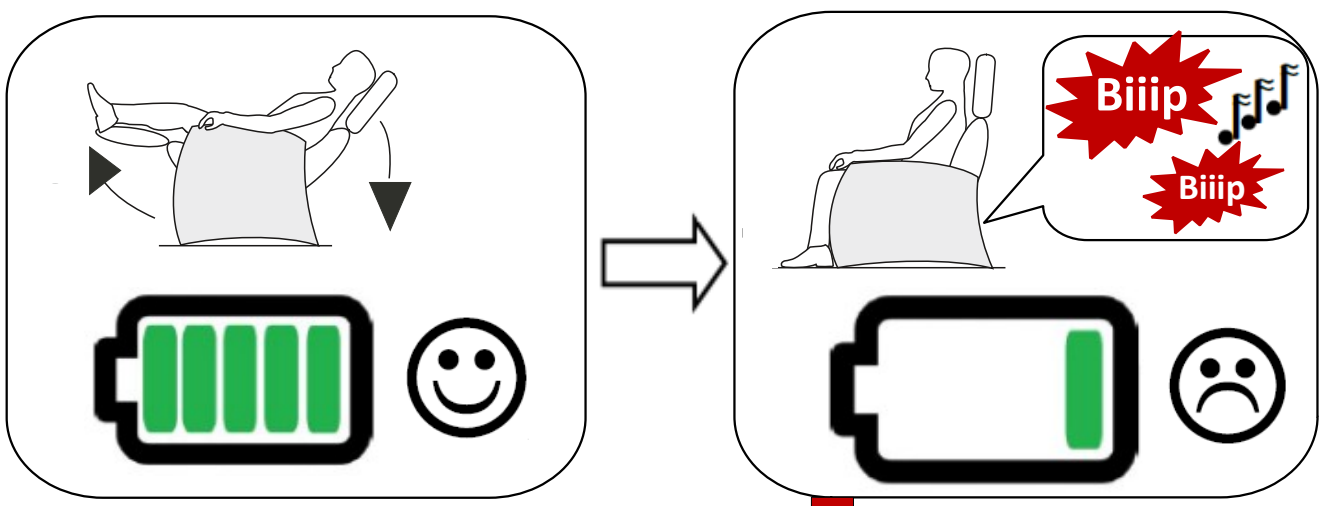

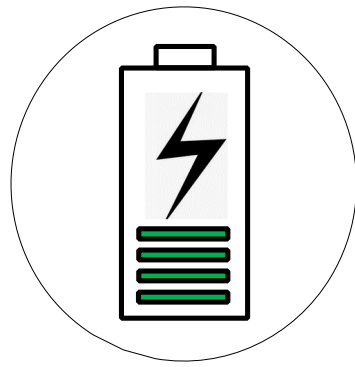

+/- 11,5 h

1

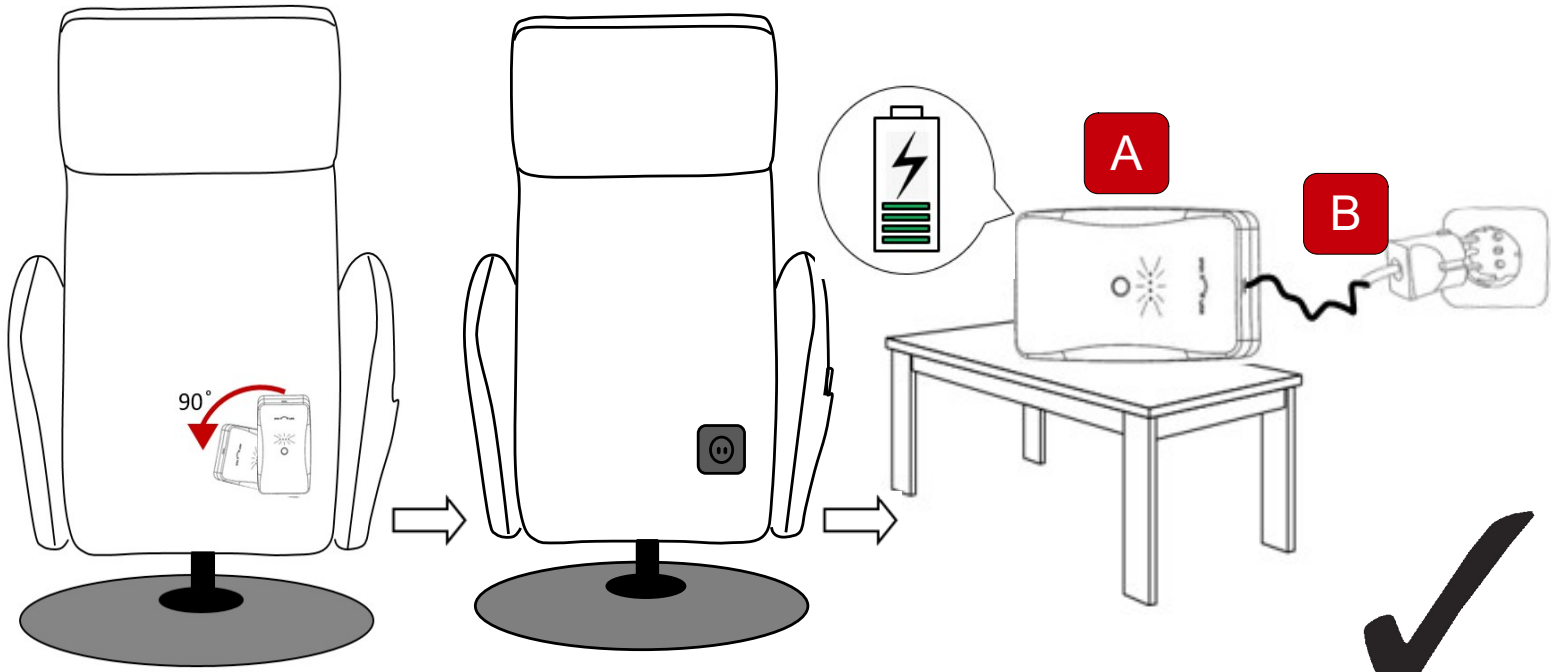

2

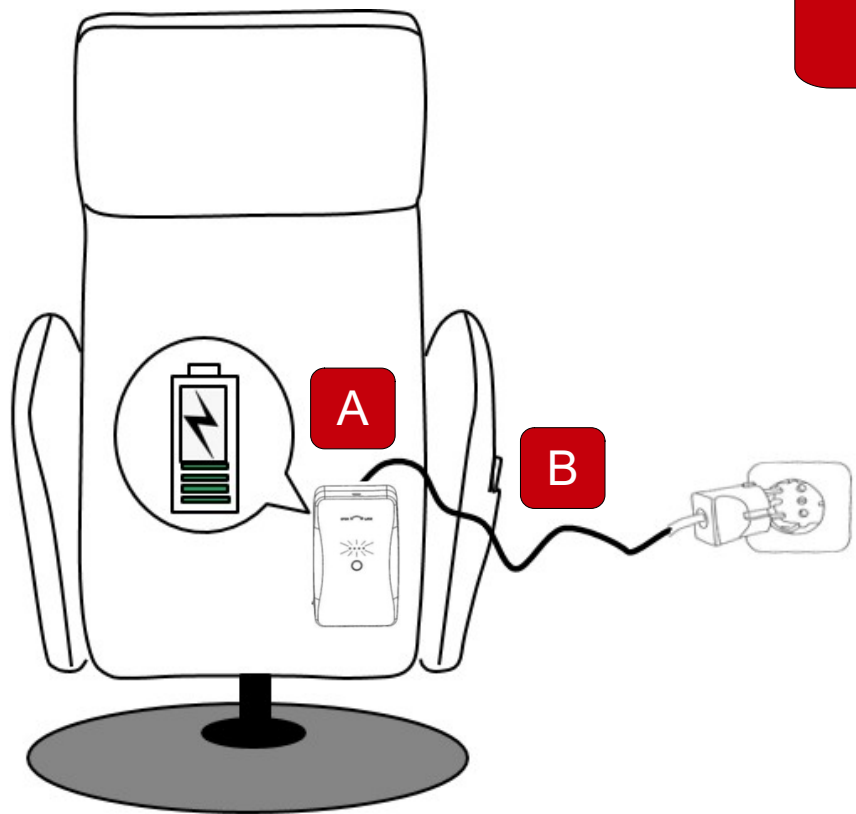

5

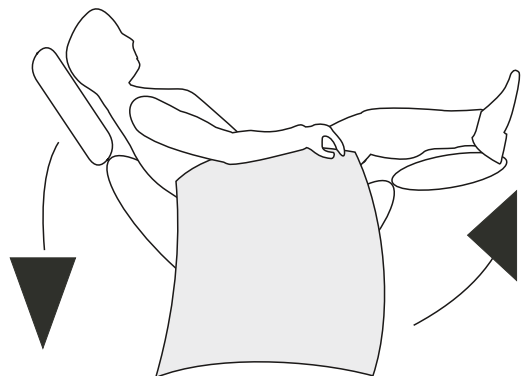
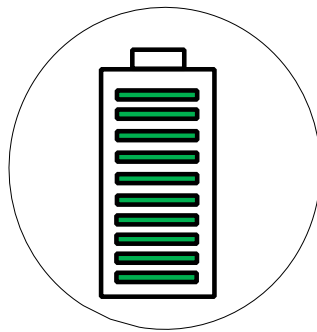
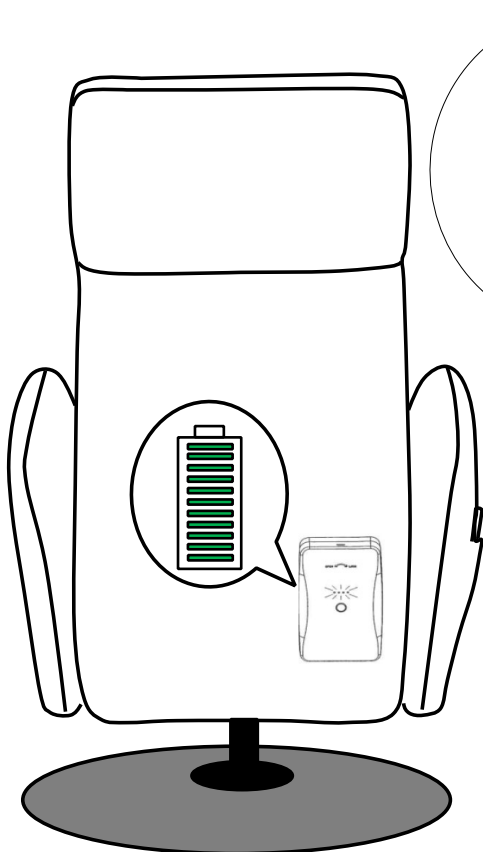
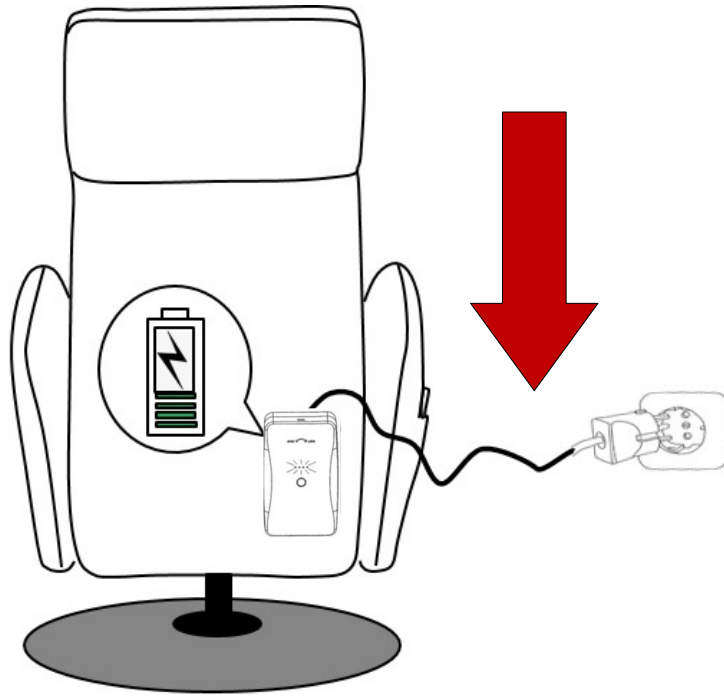
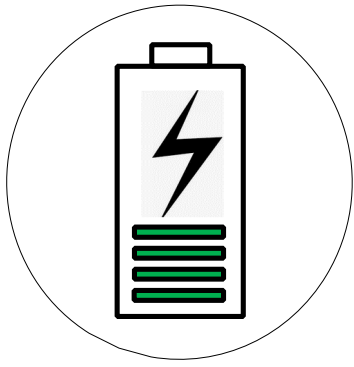

1. Technische Daten

Zelle: 18650, 25.2V, 2550mAh, 65Wh

Umgebungstemperaturbereich:

0-40° C während des Ladens

0-40° C während Entladens

Relative Feuchtigkeit:

60% RH max

Lagerungs- und Transport-Bedingungen:

Kurzzeitig (weniger als 1 Monat): -10°C+45°C, Langzeitig (weniger als 6 Monate): 23°C±10°C

1.1 Ausenmaße:

1.1.1 Akku

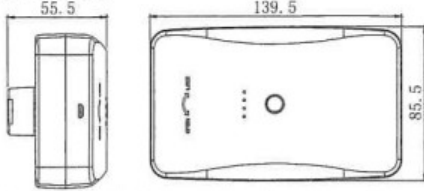

1.1.2 Verbindungstecker

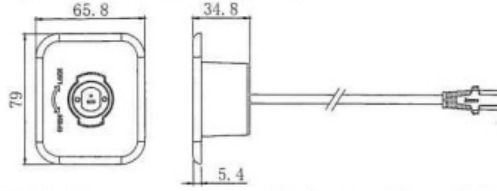

Die Anschlüsse für Ein- und Ausgabe im Bild dienen nur zur Information. Bitte nehmen Sie die Praktikabilität als Standard.

1.2 Verbindung:

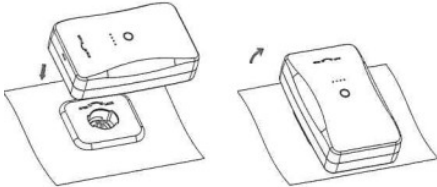

1.3 Aufladen:

Wenn der Akku summt, laden Sie ihn bitte sofort auf.

Aufladen über Micro-USB

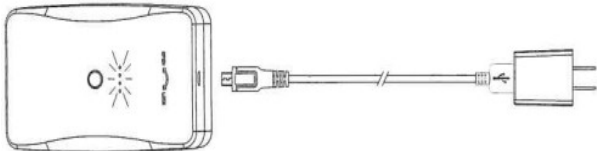

Lademöglichkeiten	Spannung	Strom	Zeit	LED-Licht	
				Aufladung	Voll aufgeladen

Micro USB	5V	2A	11.5H	Siehe unten	Siehe unten
Die LED-Anzeige zeigt an, wann das Gerät über Micro-USB geladen wird					
1 LED :	Flash	25%	kapazität aufgeladen		
2 LED :	Flash	50%	kapazität aufgeladen		
3 LED :	Flash	75%	kapazität aufgeladen		
4 LED :	ON	100%	voll aufgeladen		

2. Sicherheitshinweise:

- Laden Sie den Akku vor dem ersten Gebrauch vollständig auf.
Die Ladezeit per Micro-USB beträgt ca. 11.5 Stunden.
- Wenn der Akku summt, bitte umgehend laden.
- **WARNUNG-** Die Handhabung von Li-Ionen-Batterien muss mit großer Vorsicht erfolgen. Li-Ionen Akkumulatoren können bei unsachgemäßer Verwendung große Hitze erzeugen und Gerät und Umgebung beschädigen. Alle der Batterie beiliegenden Anweisungen müssen gelesen werden.
- Behandeln sie das Gerät pfleglich! Nicht werfen, fallen lassen, oder starken Vibrationen aussetzen. Sollte das Gerät beschädigt worden sein, darf Gerät nicht in Betrieb genommen werden.
- Nicht dem Feuer aussetzen oder auseinander bauen!
- Das Gerät nicht ins Wasser tauchen!
- Von Kindern fern halten!
- Lagerung in trockener, gut belüfteter Umgebung
- Die Nennspannung oder Stromstärke des Akku darf nicht überschritten werden. Nur mit dem dafür vorgesehenen Netzteil verwenden.
- Den Akku nur innerhalb der genannten Parameter lagern und betreiben.
- Nach 3 monatiger Lagerung den Akku komplett laden. auch wenn er nicht benutzt wird.

Hersteller:

Huizhou Zhongbang Electronics Co., Ltd.

No.2 Pingnan Mid-road, Pingnan Industrial District Huizhou, Guangdong China

Made in China



1. Spécifications

Cellule:18650,25.2V,2550mAh,65Wh

Plage de température ambiante:

0-40°C au cours de la charge

0-40°C au cours de la décharge

Humidité:

60% Humidité relative max

Conditions de stockage et de transport:

Court terme (moins de 1 mois):-10°C +45°C,Long terme (moins de 6 mois):23°C±10°C

1.1 Dimensions extérieures:

1.1.1 Bloc-batterie

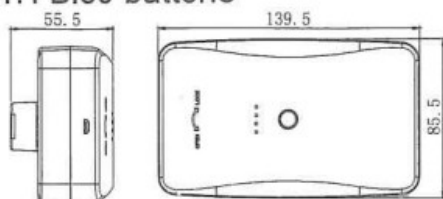

1.1.2 Connecteur

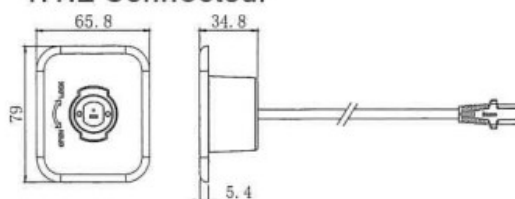

Les connecteurs d'entrée et de sortie dans cette figure sont présentés uniquement à titre indicatif. Veuillez prendre le vrai comme standard.

1.2 Câblage:

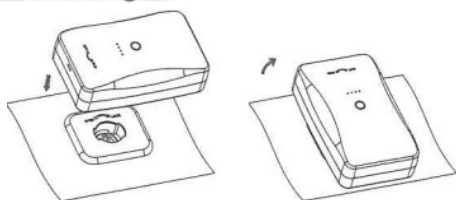

1.3 Charge:

Si la batterie bourdonne, veuillez la recharger immédiatement.

Charge avec le Micro USB

Moyens de charge	Tension	Courant	Temps	Voyant LED	
				Charge en cours	Complètement chargée

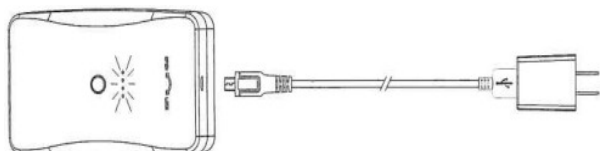

Micro USB	5V	2A	11.5H	Voir ci-dessous	Voir ci-dessous
Le voyant LED indique au cours de la charge avec le Micro USB.					
1 LED :	Flash	25%	Capacité chargée		
2 LED :	Flash	50%	Capacité chargée		
3 LED :	Flash	75%	Capacité chargée		
4 LED :	ON	100%	Complètement chargée		

2. Sécurité :

- Charger complètement le bloc-batterie avant sa première utilisation.
Le temps de charge avec le Micro USB est d'environ 11.5 heures.
- Si le bloc-batterie bourdonne, veuillez le recharger immédiatement.
- Avertissement - L'utilisation de la batterie lithium-ion doit être extrêmement prudente. Toutes les instructions fournies avec le bloc-batterie doivent être lues.
- Le bloc-batterie doit être traité avec beaucoup de soin! Ne le jetez pas, ne le laissez pas tomber et ne l'exposez pas à de fortes vibrations. S'il a été endommagé, il ne doit pas être utilisé.
- Vous ne devez jamais le démonter, ni l'exposer au feu!
- Ne le plongez pas dans l'eau!
- Garder hors de portée des enfants!
- Conserver dans un endroit sec et bien ventilé.
- Il est interdit de dépasser la tension et le courant de la batterie. Utilisez uniquement avec l'alimentation électrique fournie.
- Utiliser et conserver la batterie en respectant ces paramètres.
- Après 3 mois de stockage, il faut charger complètement la batterie, même si elle n'est pas utilisée.

Fabricant:

Huizhou Zhongbang Electronics Co., Ltd.

No 2, Rue de Pingnanzhong, District industriel de Pingnan, Huizhou, Guangdong, Chine

Fabriqué en Chine



limoss GmbH & Co. KG
Oberwengener Str.204
D-58300 Wetter
Tel. +49 2335 84713-0
Fax +49 2335 84713-29
limoss@limoss.de
www.limoss.de

1. Specifications

Cell:18650,25.2V,2550mAh,65Wh

Ambient temperature range:

0-40°C during charging

0-40°C during discharging

Humidity:

60% RH max

Storage and transport conditions:

Short-term (less than 1 month):-10°C+45°C,Long-term (less than 6 months):23°C±10°C

1.1 External dimensions:

1.1.1 Battery Pack

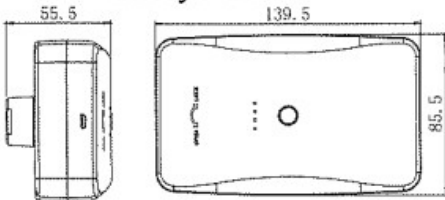

1.1.2 Connector

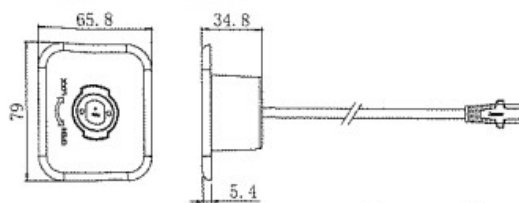

The connector of input and output in picture are only for information, please take practicality as standard.

1.2 Connection:

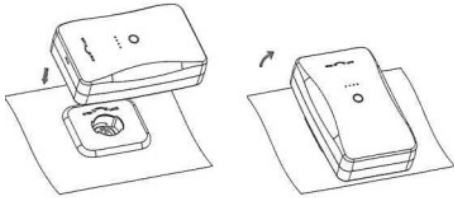

1.3 Charge:

If battery is humming, please recharge immediately.

Charge by micro USB

Charging Ways	Voltage	Current	Time	LED light	
				Charing	Fully Charged

Micro USB	5V	2A	11.5H	see below	see below
-----------	----	----	-------	-----------	-----------

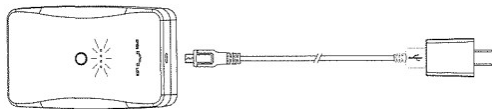

The Led light indicating when charged by Mico USB

1 LED :	Flash	25% capacity charged
2 LED :	Flash	50% capacity charged
3 LED :	Flash	75% capacity charged
4 LED :	ON	100% fully charged

2. Safety:

- Charge battery pack before first use once completely.
The charging time by micro USB is approximately 11.5 Hours.
- If battery pack is humming, please recharge immediately.
- WARNING-use of Li-Ion batteries must be extremely carefully. All instructions provided with the battery pack must be read.
- Battery pack should be treated with great care! Do not throw, drop, or expose it to strong vibrations.
If unit has been damaged, it must not be put into operation.
- Do not expose to fire or disassemble!
- Do not immerse in water!
- Keep away from children!
- Storage in dry well-ventilated area.
- The voltage or amperage of battery must not be exceeded.
Use with the provided power supply only.
- Operate and Store battery within those parameters.
- After 3 months of storage, charge the battery fully. even if it is not used.

Manufacturer:

Huizhou Zhongbang Electronics Co., Ltd.

No.2 Pingnan Mid-road, Pingnan Industrial District Huizhou, Guangdong, China

Made in China



limoss GmbH & Co. KG
Oberwengener Str.204
D-58300 Wetter
Tel. +49 2335 84713-0
Fax +49 2335 84713-29
limoss@limoss.de
www.limoss.de



**Sicherheitshinweise • Safety instructions • Consignes de sécurité •
Norme di sicurezza • Veiligheidsinstructies • Wskazówki bezpieczeństwa •
Bezpečnostní pokyny • Bezpečnostné pokyny • Biztonságtechnikai
tudnivalók • Instrucțiuni referitoare la siguranță • Güvenlik uyarıları •
Правила техники безопасности**

D Aus Batterien ausgelaufene elektrolytische Flüssigkeit kann zu Verätzungen führen.
GB Electrolytic fluid that has leaked out of the batteries can cause chemical burns.
FR Le liquide électrolytique s'écoulant des piles peut provoquer des brûlures chimiques.
IT La fuoriuscita di liquido elettrolitico dalle batterie può causare ustioni.
NL Elektrolytische vloeistof die uit batterijen lekt, kan leiden tot bijtende wonden.
PL W przypadku wycieku elektrolitu z baterii może dojść do poparzeń.
CZ Elektrolytická kapalina vytékající z baterií může způsobit poleptání.
SK Elektrolytická kvapalina vytečená z batérií môže spôsobiť poleptanie.
HU Az elemekből kifolyt elektrolit folyadék égési sérülést okozhat.
RO Lichidele electrolitice scurse din baterii pot cauza leziuni.
TR Pillerden dışarı sızan elektrolitik sıvı, asit yanıklarına sebep olabilir.
RU Электролит, вытекший из батарей, может привести к ожогам.

D Batterien und Akkus dürfen Sie nicht erhitzen, kurzschließen oder durch Verbrennen beseitigen.
GB You must not heat or short circuit batteries and rechargeable batteries or dispose of them in fire.
FR Il est interdit de chauffer, court-circuiter ou éliminer les piles et les accus en les brûlant.
IT Le batterie e batterie ricaricabili non devono essere riscaldate, cortocircuitate o smaltite mediante combustione.
NL Batterijen en accu's mag u niet verhitten, kortsluiten of door verbranding vernielen.
PL Baterii ani akumulatorów nie można podgrzewać, powodować ich zwarcia ani utylizować poprzez spalanie.
CZ Baterie a akumulátory nesmíte zahřívát, zkratovat nebo likvidovat spalováním.
SK Batérie a akumulátory nesmiete zahrievať, skratovať alebo likvidovať pálením.
HU Tilos az elemeket és akkumulátorokat felhevíteni, rövidre zárnı vagy elégetni.
RO Preveniți încălzirea, scurtcircuitarea sau eliminarea prin ardere a bateriilor și a acumulatorilor.
TR Pil ve aküleri ısıtmayın, kısa devre yaptırmayın veya yakmak suretiyle bertaraf etmeyin.
RU Запрещается нагревать батареи и аккумуляторы, закорачивать или утилизировать их посредством сжигания.

D Batterien/Akkus (insbesondere Lithiumbatterien/Akkus) können sich bei unsachgemäßem Umgang übermäßig erhitzen und ggf. sogar explodieren.
GB Batteries/rechargeable batteries (in particular lithium batteries/rechargeable batteries) may heat up excessively and even explode if used improperly.
FR En cas de manipulation incorrecte, les piles/accus (notamment les piles/accus au lithium) peuvent fortement chauffer, voire même exploser.
IT Batterie/batterie ricaricabili (in particolare batterie/batterie ricaricabili al litio) possono riscaldarsi eccessivamente in caso di uso improprio e probabilmente anche esplodere.
NL Batterijen/accu's (in het bijzonder lithiumbatterijen/accu's) kunnen bij een verkeerde hantering buitensporig warm worden en eventueel zelfs exploderen.
PL W przypadku niewłaściwego użytkowania baterie/akumulatory (zwłaszcza baterie/akumulatory litowe) mogą nadmiernie się rozgrzać, a nawet wybuchnąć.
CZ Baterie/akumulátory (zejména lithiové baterie/akumulátory) se mohou v případě nesprávné manipulace přehřát anebo dokonce mohou explodovat.
SK Batérie/akumulátory (najmä lítiové batérie/akumulátory) sa pri neodbornej manipulácii môžu nadmerne zahriať a v krajnom prípade dokonca vybuchnúť.
HU Az elemek/akkumulátorok (különösen a lítium elemek/akkumulátorok) a rendeltetésellenes használat során túlmelegedhetnek és akár fel is robbanhatnak.
RO Utilizarea necorespunzătoare a bateriilor/acumulatorilor (în special a bateriilor/acumulatorilor cu litiu) poate cauza supraîncălzirea, resp. explozia acestora.
TR Piller/aküler (özellikle lityum pilleri/aküleri) uygun olmayan kullanımda aşırı ısınabilir ve hatta duruma göre patlayabilirler.
RU Батареи/аккумуляторы (в частности, литиевые батареи/аккумуляторы) при

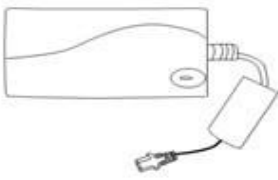
Benutzer- und Entsorgungshinweis

	
<p>Power supply: YH-A290020-A MOPS08156 Input: 100-240V~, 50/60Hz, 1.3A Output: 29.0V== 2.0A</p>	
<p>WEEE Rg.-Nr. DE 49167192</p>	

Achtung!

Das Möbel darf nur mit dem mitgelieferten Trafo und Kabel betrieben werden!

Dieses Gerät kann von Kindern ab 8 Jahren und darüber sowie von Personen mit verringerten physischen, sensorischen oder mentalen Fähigkeiten oder Mangel an Erfahrung und Wissen benutzt werden, wenn sie beaufsichtigt oder bezüglich des sicheren Gebrauchs des Gerätes unterwiesen wurden und die daraus resultierenden Gefahren verstehen.

Reinigung und Benutzerwartung dürfen nicht von Kindern ohne Beaufsichtigung durchgeführt werden.

Entsorgungshinweis

Elektro – Altgeräte umweltgerecht entsorgen

Elektrogeräte sind mit dem folgenden Symbol gekennzeichnet, welches bedeutet, dass Elektro- und Elektronikgeräte nicht über den Hausmüll entsorgt werden dürfen.



Das Produkt darf nicht über den Hausmüll entsorgt werden.

Die Entsorgung erfolgt an zugelassenen Sammel- und Rücknahmestellen.

Elektrogeräte enthalten wertvolle Ressourcen und auch Schadstoffe. Jeder Verbraucher ist deshalb gesetzlich verpflichtet, Elektro – Altgeräte an einer zugelassenen Sammel- oder Rücknahmestelle, zum Beispiel beim lokalen Wertstoff- oder Recyclinghof, abzugeben. Elektro- Altgeräte werden dort kostenlos angenommen und einer umwelt- und ressourcenschonenden Verwertung zugeführt.

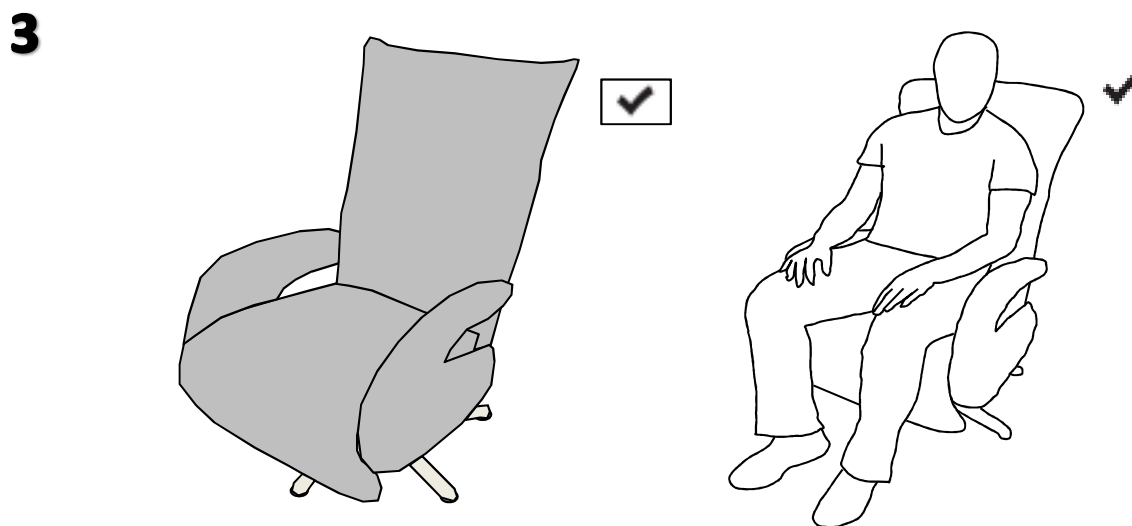
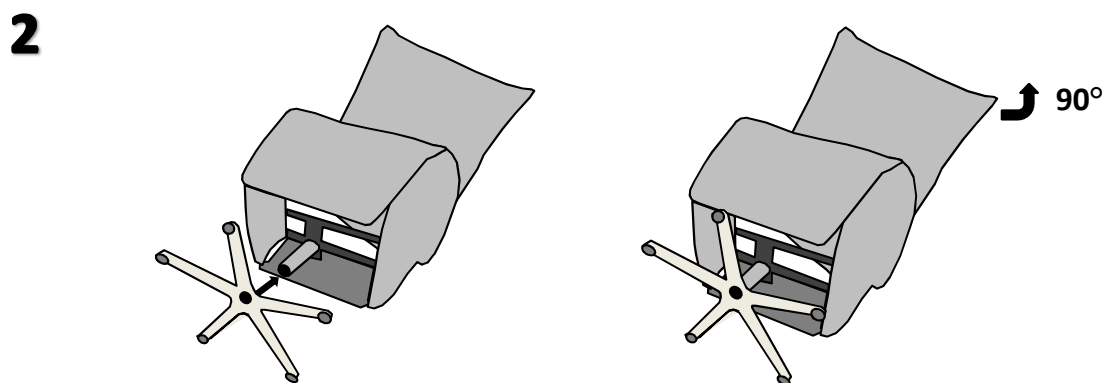
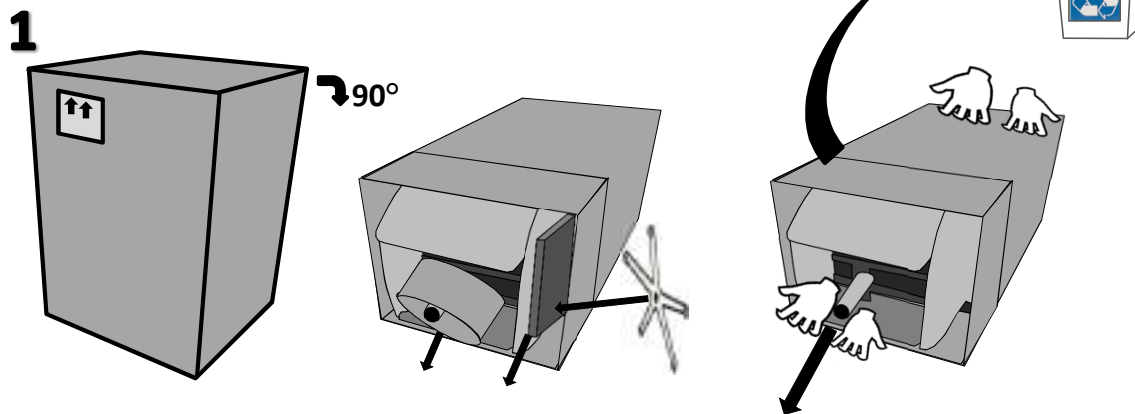

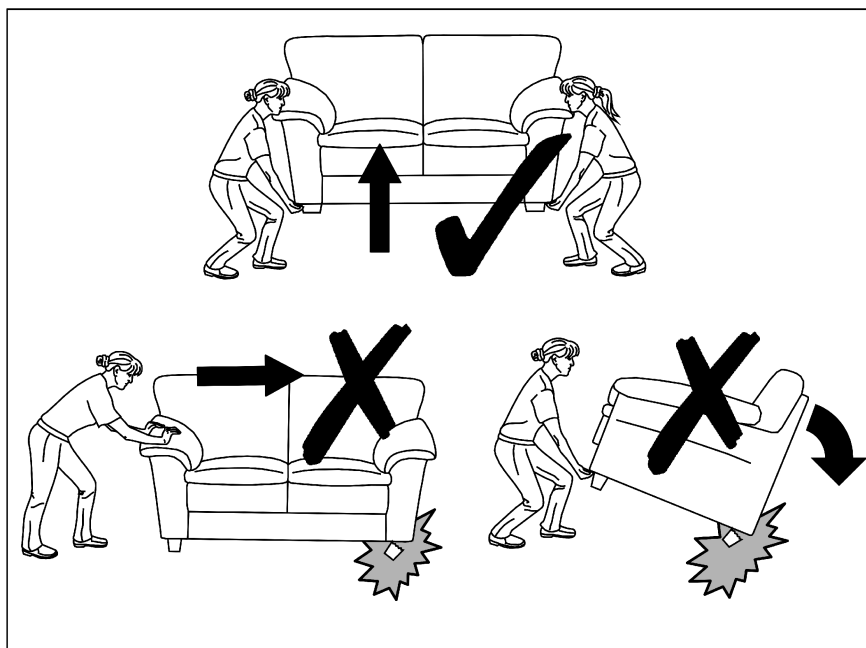
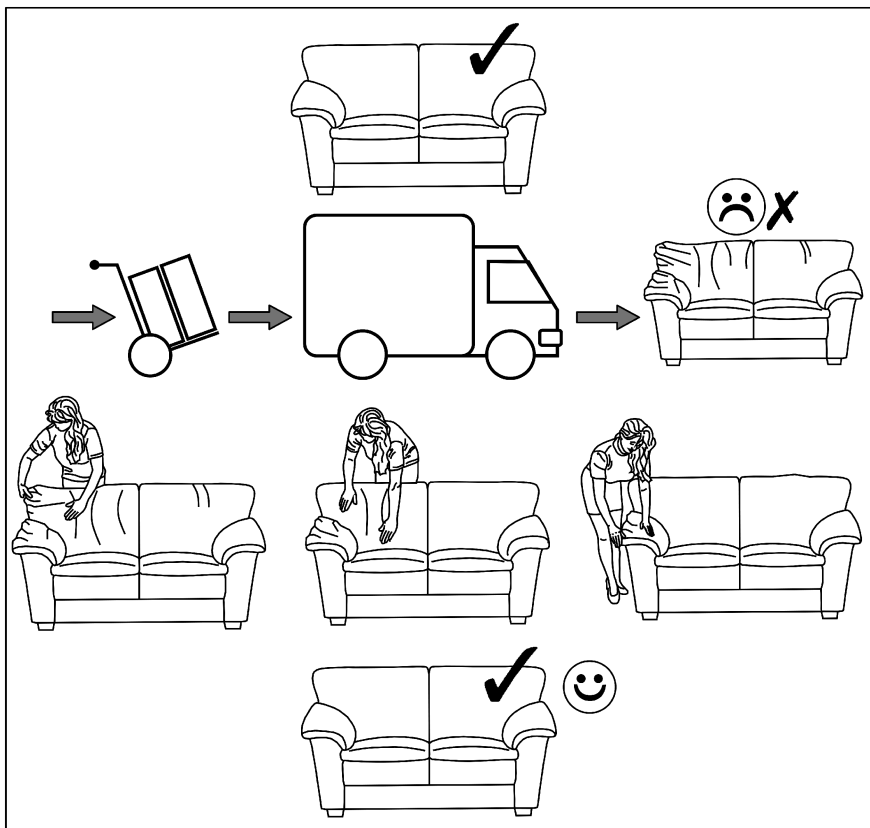
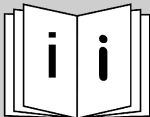

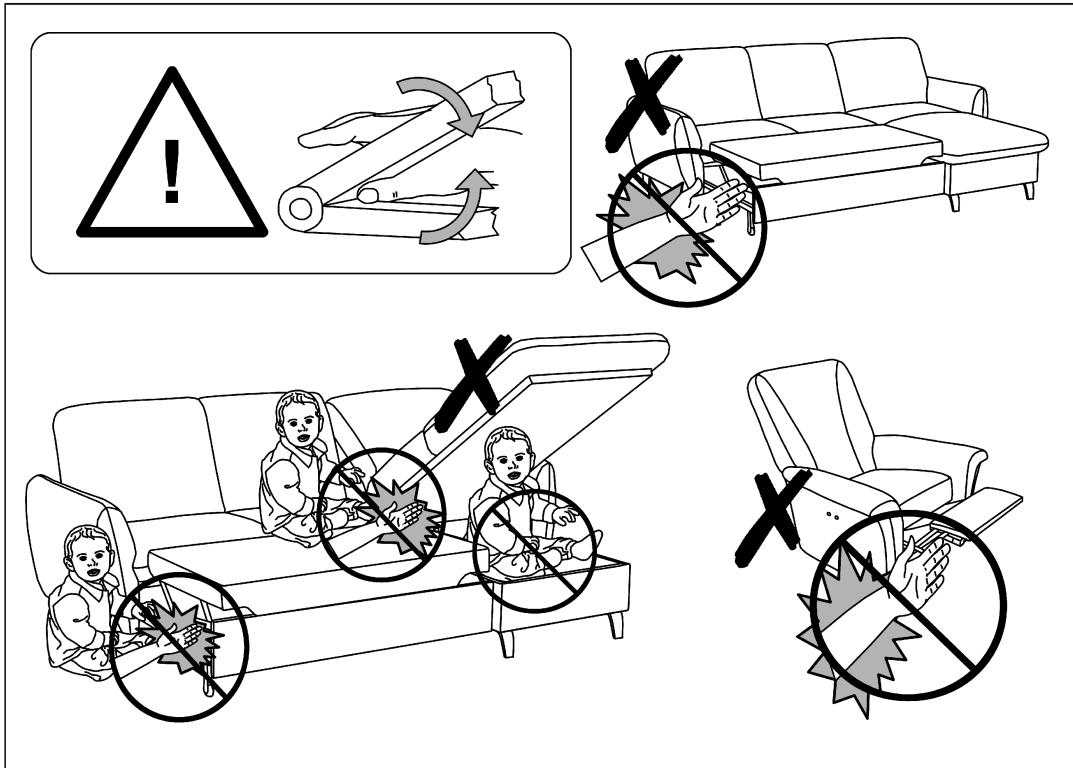
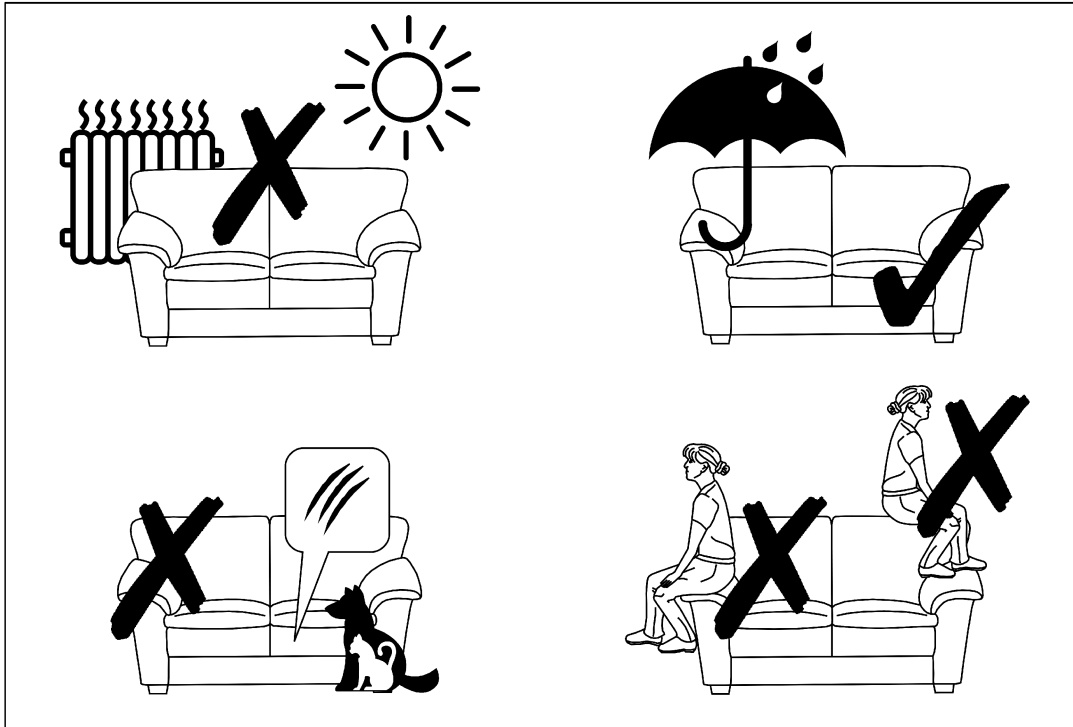

(DE) PFLEGEHINWEISE:

1. SORGFÄLTIG ENTSTAUBEN
2. MIT EINEM WEICHEN, SAUBEREN UND FEUCHTEM TUCH UND LEICHTER SEIFENLAUGE REINIGEN

	DEKOR PAPIER	OBERFLÄCHE LAMINAT	OBERFLÄCHE LACK	LACKIERTEN HOLZ	TEXTIL LEDER
SEIFENLAUGE (NEUTRAL SEIFE)	✓	✓	✓	✓	✓
WASSER MIT HAUSHALTREINIGER		✓	✓		
REINIGUNG NACH HERSTELLERVORGABE					✓

- BENUTZEN SIE KEINE SCHEUERMITTEL WIE PULVER, STAHLWOLLE, LÖSUNGSMITTEL
- NICHT ZU NASS ABWISCHEN

(GB) CONSERVATION ADVICES:

1. CAREFULLY WIPE OFF THE DUST
2. MOISTEN A SOFT, CLEAN CLOTH WITH SOAPY WATER

	VEENER WOOD	LAMINATE SURFACE	LAMINATED WOOD SURFACE	VARNISHED SURFACE	FABRIC LEATHER
WATER WITH SOAP (GREY SOAP)	✓	✓	✓	✓	✓
WATER WITH DETERGENT		✓	✓		
MAINTENANCE PRESCRIBED BY THE MANUFACTURER					✓

- DO NOT USE ABRASIVE PRODUCTS: POWDERS, STEEL WOOL, SOLVENTS
- DO NOT OVER-WET

(FR) CONSEILS D'ENTRETIEN:

1. DÉPOUSSIERER SOIGNEUSEMENT
2. HUMIDIFIER UN CHIFFON DOUX ET PROPRE D'EAU SAVONNEUSE

	BOIS DE PLACAGE	SURFACES STRATIFIÉES	SURFACES LAQUÉES	BOIS VERNIS	TISSU CUIR
EAU SAVONNEUSE (SAVON NEUTRE)	✓	✓	✓	✓	✓
EAU ADDITIONNÉE DE DÉTERGENT		✓	✓		
ENTRETIEN SPÉCIFIQUE FABRICANT					✓

- NE JAMAIS UTILISER DE PRODUITS ABRASIFS: POUDRE À RÉCURER, LAINE D'ACIER, SOLVANTS
- NE PAS TROP MOUILLER

(PL) PORADY W ZAKRESIE KONSERWACJI:

1. ZETRZEĆ DOKŁADNIE KURZ
2. CZYSTĄ I DELIKATNĄ ŚCIERECZKĘ ZWILŻYĆ LEKKO W WODZIE Z NIEWIELKĄ ILOŚCIĄ MYDŁA

	OKLEINA	POWIERZCHNIA LAMINATU	POW. DREWNA LAKOWANEGO	POWIERZCHNIA LAKIEROWANA	TKANINA SKÓRA
WODA Z MYDŁEM (SZARE MYDŁO)	✓	✓	✓	✓	✓
WODA Z DODATKIEM ŚRODKA MYJĄCEGO		✓	✓		
KONSERWACJA ŚCIŁIE WEDŁUG ZALECEŃ PRODUCENTA					✓

- NIGDY NIE UŻYWAĆ PRODUKTÓW ŚCIERNYCH: PROSZKÓW, DRAPAKÓW, ROZPUSZCZALNIKÓW
- NIE MOCZYĆ DUŻĄ ILOŚCIĄ WODY

(IT) CONSIGLI PER LA MANUTENZIONE:

1. SPOLVERATE ACCURATAMENLE
2. INUMIDIRE CON ACQUA LEGGERMENTE INSAPONATA UNO STRACCIO MORBIDO PULITO

	CARTA	SUPERFICIE STRATIFICATA	SUPERFICIE LACCATE	LACCATE E LEGNO VERNICIATO	TESSILE PELLE
ACQUA CON SAPONE (SAPONE NEUTRO)	✓	✓	✓	✓	✓
ACQUA CON DETERSIVO SAN MARO		✓	✓		
MANUTENZIONE SPECIFICA PRODUTTORE					✓

- NON UTILIZZARE MAI PRODOTTI ABRASIVI: POLVERE, LANA DI ACCIAIO, SOLVENTI
- NON BAGNARE TROPPO

(ES) CONSEJOS PARA EL MANTENIMIENTO:

1. LIMPIAR EL POLVO CON CUIDADO
2. HUMEDECER UN PAÑO SUAVE Y LIMPIO CON AGUA LIGERAMENTE ENJABONADA

	CHAPA DE MADERA	SUPERFICIE LAMINADA	MADERA BARNIZADA	SUPERFICIE LACADA	TELA PIEL
AGUA Y JABON (JABON NEUTRO)	✓	✓	✓	✓	✓
AGUA CON DETERGENTE		✓	✓		
MANTENIMIENTO ESPECIFICO DEL FABRICANTE					✓

- NO USE NUNCA PRODUCTOS ABRASIVOS TALES COMO POLVO DE LIMPIAR, RASCADOR, DISOLVENTES
- NO MOJAR EXAGERADAMENTE

(PT) CONSELHOS PARA A MANUTENÇÃO:

1. LIMPE O POEIRO COM CUIDADO
2. UMEDECER UM PAÑO SUAVE E LIMPO COM AGUA E UM POUCO DE SABAO

	PLACA DE MADEIRA	SUPERFÍCIE LAMINADA	MADEIRA ENVERNIZADA	SUPERFÍCIE LACADA	TELA PELE
AGUA COM SABÃO (SABÃO NEUTRO)	✓	✓	✓	✓	✓
AGUA COM ST MARC		✓	✓		
INSTRUÇÕES ESPECÍFICAS					✓

- NUNCA UTILIZAR PRODUTOS ABRASIVOS POS, LA DE AÇO, SOLVENTES
- NAO MOLHAR DEMASIADO

(SK) TYPY NA ÚDRŽBU:

1. PRACH DOKŁADNE UTRITE
2. ČISTU A JEMNU HANDRIČKU NAVLHČIŤ LAHKO VO VODE Z MALÝM MNOŽSTVOM MYDLA

	TENKÁ LAMINÁTOVÁ	LAMINÁTOVÝ POVRCH	DREVENÝ POVRCH LAKOVANÝ	LAKOVANÝ POVRCH	TKANINA ČALÚDNEŇÁ
VODA Z MYDLOM	✓	✓	✓	✓	✓
VODA Z UMYVAJÚCIM PROSTRIEDKOM		✓	✓		
ÚDRŽBA IBA PODĽA POPISU VÝROBCU					✓

- NIKDY NEPOUŽÍVAŤ PROSTRIEDKY S DRSNÝM POVRCHOM : PRAŠKOV, DROBENIEK A RIEDIDIEL• NENAMÁČAJTE VEĽKÝM MNOŽSTVOM VODY

(CZ) TYPY NA UDRŽBU:

1. DŮKLADNĚ OTRIT PRACH
2. ČISTÝ A MĚKKÝ HADRÍK LEHCE NAVLHČIT VE VODĚ S MALÝM MNOŽSTVÍM MÝDLA

	DÝHA	LAMINÁTOVÝ POVRCH	LAKOVANÝ DŘEVĚNÝ POVRCH	LAKOVANÝ POVRCH	KOŽENÁ ČALOUNĚNÁ LÁTKA
VODA S MÝDLEM	✓	✓	✓	✓	✓
VODA S ČISTIČÍM PROSTŘEDKEM		✓	✓		
DODRŽET ÚDRŽBU POSKYTOVANOU VÝROBCEM					✓
• NEPOUŽÍVEJTE ABRÁZIVNÍ PROSTŘEDKY: PRASEK, ROZPOUSTĚDLA					
• NENAMACĚJTE VELKÉ MNOŽSTVÍ VODY					

(NL) ONDERHOUDSVOORSCHRIFT:

1. ZORGVULDIG STOFVRIJ MAKEN
2. MET EEN ZACHTE SCHONE EN VOCHTIGE DOEK MET NEUTRALE ZEEP REINIGEN

	FOLIE	TOPLAAG LAMINAAT	TOPLAAG LAK	GELAKT HOUT	TEXTIEL LEER
NEUTRALE ZEEP	✓	✓	✓	✓	✓
WATER MET HUISHOUD REINIGINGSMIDDEL		✓	✓		
DOOR DE PRODUCENT GESPECIFICEERD ONDERHOUD					✓
• GEBRUIKT U GEËN SCHUURMIDDELEN ZOALS SCHUURPOEDER, STAALWOL, OPLOSMIDDEL					
• NIET TE NAT AFNEMEN					

(HU) KARBANTARTÁSI TANÁCSOK:

1. ALAPOSAN LETÖRÖLNI A PORT
2. EGY TISZTA ÉS LÁGY TÖRLŐKENDŐT BENEDVESÍTENI ENYHÉN SZAPPANOS VÍZZEL

	FURNÉR	LAMINÁLT FELÜLET	LAKKOZOTT FAFELÜLET	LAKKOZOTT FELÜLET	BŐRKÁRPIT
SZAPPANOS VÍZ (MOSÓSZAPPAN)	✓	✓	✓	✓	✓
MOSÓSZERES VÍZ		✓	✓		
KARBANTARTÁS SZIGORÚAN A GYÁRTÓ UTASÍTÁSAI SZERINT					✓
• SOHA NE HASZNÁLJON SÚROLO HATASU TISZTÍTÓSZERT: PORT, KAPAROT, OLDOSZERT					
• NE ZATASSA BO VÍZZEL					

(RO) SFATURI PENTRU ÎNTREȚINERE:

1. ȘTERGEȚI BINE PRAFUL
2. UMEZIȚI UȘOR O LAVETĂ USCATĂ ȘI DELICATĂ ÎN APĂ CU PUȚIN SĂPUN

	FURNIR	SUPRAFAȚĂ LAMINAT	SUPRAFAȚĂ LEMN LĂCUIȚ	SUPRAFAȚĂ LĂCUIȚĂ	ȚESĂTURĂ CĂPTUȘEALĂ PIELE
APĂ CU SĂPUN	✓	✓	✓	✓	✓
APĂ CU DETERGENT		✓	✓		
ÎNȚREȚINEȚI ÎN CONFORMITATE STRICTĂ CU RECOMANDĂRILE PRODUCĂTORULUI					✓
• NU FOLOSIȚI NICIODATĂ PRODUSE ABRAZIVE: DETERGENȚI PRF, ZGĂRIETOARE, DILUANȚI					
• NU SPĂLAȚI CU O CANTITATE MARE DE APĂ					

(RU) РЕКОМЕНДАЦИИ ПО УХОДУ:

1. ТЩАТЕЛЬНО ВЫТЕРЕТЬ ПЫЛЬ
2. ЧИСТУЮ И МЯГКУЮ ТРЯПОЧКУ СЛЕГКА УВЛАЖНИТЬ В ВОДЕ С НЕБОЛЬШИМ КОЛИЧЕСТВОМ МЫЛА

	ОБЛИЦОВКА	ЛАМИНИРУЮЩА Я ПЛЁНКА	ПОВЕРХНОСТЬ ЛАКИРОВАННОЙ ДРЕВСИНЫ	ЛАКИРОВАННАЯ ПОВЕРХНОСТЬ	ОБИЧОВАЯ ТКАНЬ, КОЖА
ВОДА С МЫЛОМ (ХОЗЯЙСТВЕННОЕ МЫЛО)	✓	✓	✓	✓	✓
ВОДА С ДОБАВКОЙ МОУЩЕГО СРЕДСТВА		✓	✓		
УХОД СТРОГО ПО УКАЗАНИЯМ ПРОИЗВОДИТЕЛЯ					✓
• НИ В КОЕМ СЛУЧАЕ НЕ ИСПОЛЬЗОВАТЬ АБРАЗИВНЫХ ИЗДЕЛИЙ: ПОРОШКОВ, ЦАРАПОК, РАСТВОРИТЕЛЕЙ					
• НЕ СМАЧИВАТЬ БОЛЬШИМ КОЛИЧЕСТВОМ ВОДЫ					

(TU) BAKIM TALÍMATLARI:

1. TOZUNU DIKKATLICE ALINIZ
2. YUMUŞAK VE TEMİZ BİR BEZİ SABUNLU SU İLE ISLATINIZ

	KAPLAMA	LAMİNAT YÜZEY	LAKE AHŞAP YÜZEY	LAKE YÜZEY	DÖŞEMELİK KUMAŞ, DERİ
SABUNLU SU (NORMAL SABUN)	✓	✓	✓	✓	✓
DETERJANLI SU		✓	✓		
ÜRETİCİNİN BAKIM VE YIKAMA TALÍMATLARI					✓
• TOZ, TEL, SOLVENT GIBI AŞINDIRICI URUNLERİ KULLANMAYINIZ					
• BOL SU İLE ISLATMAYINIZ					

(SI) NASVETI ZA VZDRŽEVANJE:

1. SKRBNO OBRISITE PRAH
2. ČISTO IN MEHKO KRPO RAHLO NAVLAŽITE V VODI Z MAJHNO KOLIČINO MILA

	FURNIR	POVRŠINA LAMINATA	POVRŠINA LES LAK	LAKIRANA POVRŠINA	OBLAZINJENJE USNJE
VODA IN MILO (MEHKO MILO)	✓	✓	✓	✓	✓
VODA Z DODATKOM DETERGENTA		✓	✓		
VZDRŽEVATI DOSLEDNO V SKLADU Z NAVODILI PROIZVAJALCA					✓
• NIKOLI NE UPORABUJATE ABRÁZIVNIH SREDSTEV: PRAŠKOV, GOBIC IZ ŽICE, TOPIL					
• NE NAMAKAJTE Z VELIKO KOLIČINO VODE					

(HR) UPUTE ZA ODRŽAVANJE:

1. PAŽLJIVO OBRISATI PRAŠINU
2. PREBRISATI ČISTOM, MEKOM TKANINOM NAVLAŽENOJ U BLAGOJ OTOPINI SAPUNA ILI DETERDŽENTA

	PAPIR	LAMINAT	LAK	DRVO	TEKSTIL KOŽA
OTPINA SAPUNA	✓	✓	✓	✓	✓
OTPINA DETERDŽENTA		✓	✓		
NAMIJENSKA SREDSTVA					✓
• ZABRANJENA JE UPOTREBA KEMIKAJIJA ILI BILO KAKVIH POMOĆNIH SREDSTAVA ZA RIBANJE JAKIH DSREDSTAVA ZA ČIŠĆENJE ILI ČELIČNE VUNE					
• ZABRANJENO JE ČIŠĆENJE SA PREVIŠE VODE/VLAGE					

Herstellerkenzeichnung:

Hergestellt für VITO durch

SCS Sp. z o.o.

Ul. Fabryczna 13

69-110 Rzepin

Polen

polsteria@steinpol.com.pl